

Dental Catalogue



*Proudly
Hand-Crafted
Instruments*

Dental Catalogue



Falcon Surgical Co. (Pvt). Ltd

HO. Falcon House, Village Golophala
Near Ugoki Town, Wazirabad Road
Sialkot Punjab 51310 Pakistan.

tel: +92-52-3510072

info@falconsurgical.co

www.falconsurgical.co

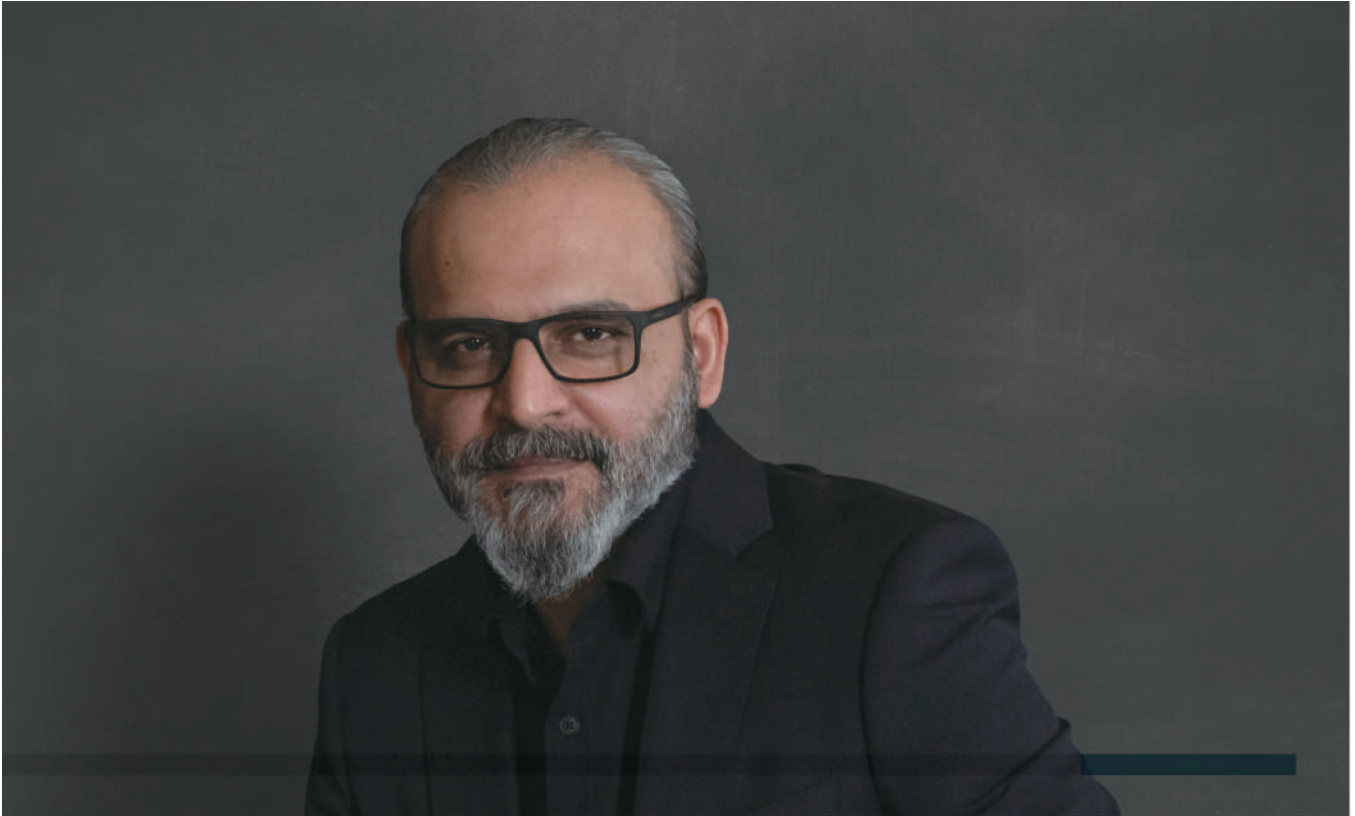

Message

Dear Valued Customers,

I am excited to announce the launch of Falcon brand dental instruments in Indonesia. As a leading manufacturer based in Pakistan since 1975, we take pride in our commitment to quality and innovation, establishing ourselves as a benchmark in the dental industry. Our products are trusted by professionals and distributed in over 50 countries worldwide.

Our pre-launch research has revealed a significant need among Indonesian dentists for high-quality instruments that are both reliable and fairly priced. Currently, the market is saturated with either overpriced Pakistani-made instruments re-exported under Italian or German brand names or low-quality non-branded alternatives.

At Falcon, we are dedicated to bridging this gap. Our products ensure you receive the quality you deserve without compromising your budget. We believe that every dentist should have access to superior quality instruments at a fair price.

Thank you for considering Falcon as your partner in dental care. We look forward to supporting your practice with our exceptional offerings.

Warm regards,

Adnan K. Hayat
Managing Director

Falcon instruments
are sold in more than
50 countries
worldwide having a
strong network of business
partners and distributors.



Over **2 million** dental
instruments in service
in **EU & USA**





The Company

Falcon Surgical, a leading manufacturer which for over thirty years has specialized in manufacturing instruments for surgery, dentistry, dental laboratories, cranio maxillo facial surgery, body care and veterinary.

Thanks to continuous innovation and the use of certified raw materials, Falcon Surgical has been able to develop such a comprehensive variety of instruments as to satisfy the varying and increasingly severe requirements of an international audience both in terms of quality and range.

Manufacturing Activities

All Falcon Instruments are made using state of the art materials and manufacturing techniques which extend to the use of sophisticated metals and alloys such as titanium and nickel titanium.

All manufacturing activities are performed under Quality Assurance conditions as laid forth by the EN ISO 9001 and 13485 norms (all of which has been certified and is being continuously monitored by recognised international bodies) and in compliance with all laws and directives ruling the distribution of Medical Devices.





Quality Guarantee

As a result of the experience accumulated in over three decades and the stringent quality control tests both in production and at the final stages of manufacturing Falcon Surgical is in a position to guarantee a consistent level of quality of any product in their range.











Customer Care









Our customer care department will be glad to help via a vis a vis request for assistance.

Your satisfaction
is our
#1 priority

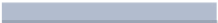
Contents

	Diagnostic Instruments	2-7
	Photography Instruments	8-11
	Periodontal Instruments	12-17
	Endodontic Instruments	18-23
	Restorative Instruments	24-44
	Anaesthesia Syringes	45-47
	Atraumatic Extraction	48-52
	Extraction Instruments	53-68
	Dental Surgery	69-81

Contents

	Implantology Instruments	82-88
	Micro Instruments	89-90
	Surgery Instruments	91-105
	Impression Accessories	106-112
	Laboratory Instruments	113-120
	Orthodontics Instruments	121-141
	Sterilizing And Sundries	142-146
	Alphabetical Index	147-151
	Numeric Index	152-160

Diagnostics

SS-200 mouth mirrors

- Made of 18-8 Stainless steel
- Sterilizable up to 200° C
- Best reflection and image quality
- Wide variety



	Fig. 2 Ø 18 mm	Fig. 2 Ø 20 mm	Fig. 2 Ø 22 mm	Fig. 2 Ø 24 mm
Front Surface	-	-	DD.503.040	DD.503.050
Magnifying	DD.506.020	DD.506.030	DD.506.040	DD.506.050
Plane	DD.509.020	DD.509.030	DD.509.040	DD.509.050

Pack of 12 pieces

Perfection mouth mirrors

- Chrome coated front surface mirror
- Wide stem offer comfortable cheek retraction



DD.515.040 Fig. 4 Ø 22 mm
DD.515.050 Fig. 5 Ø 24 mm

Micro mirrors chrome coated



DD.494.000 Fig. 000 Ø 10 mm
DD.495.000 Fig. 00 Ø 12 mm

Mirror handles



Mirror handles

- DD.528.010 Black
- DD.528.020 Blue
- DD.528.030 Light Blue
- DD.528.040 Brown
- DD.528.050 Green
- DD.528.060 Grey
- DD.528.070 Orange
- DD.528.080 Pink
- DD.528.090 Purple
- DD.528.100 Red
- DD.528.110 Turquoise
- DD.528.120 White
- DD.528.130 Yellow

Mirror handles

8 mm

SOFT LINE INSTRUMENTS
soft and sure grip



- DD.526.010 Blue
- DD.526.020 Olive
- DD.526.030 Yellow
- DD.526.040 Red
- DD.526.050 Orange

Easy
COLOR

Explorers double ended rigid

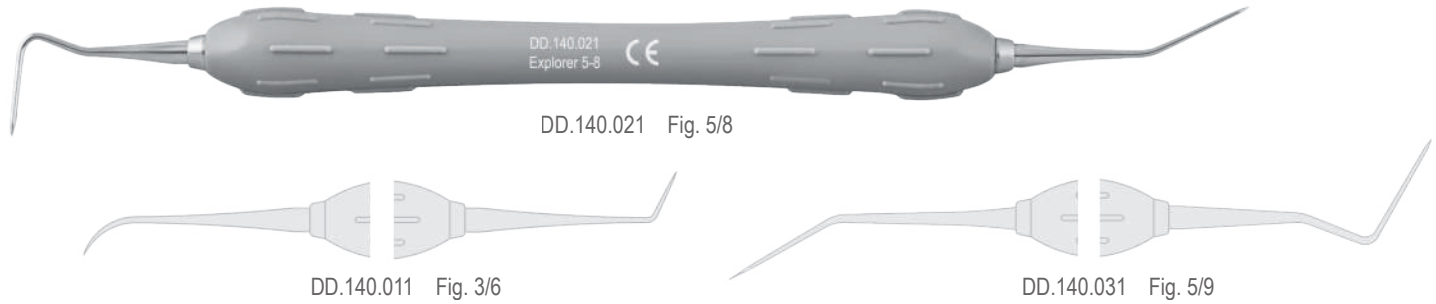

Explorers double ended flexible

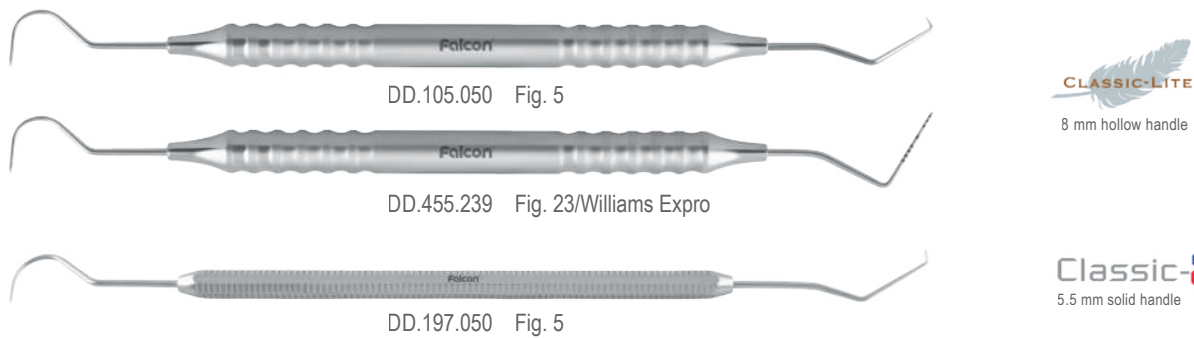

Explorers double ended flexible

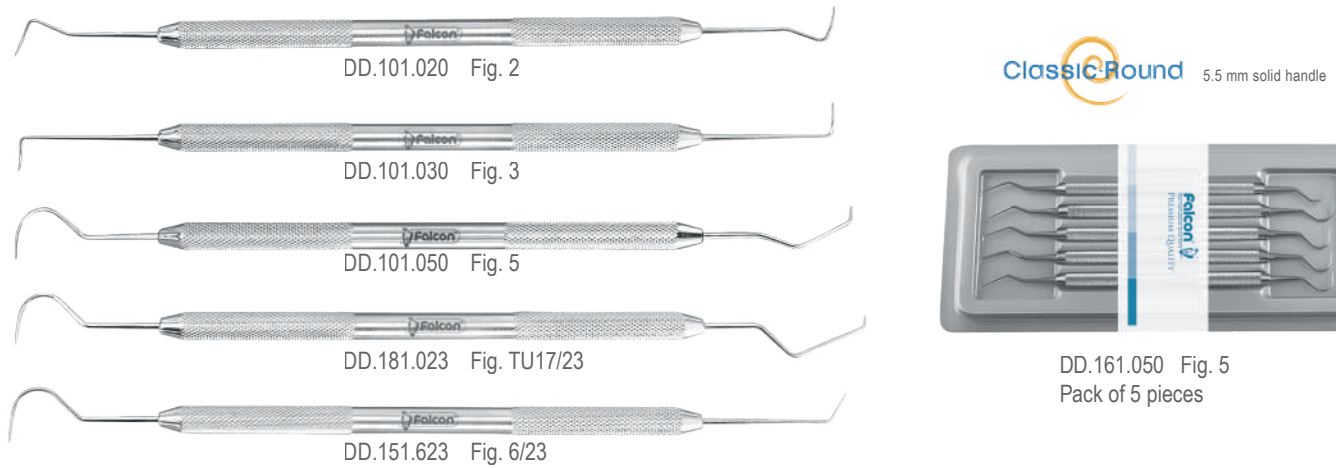

Explorers double ended rigid

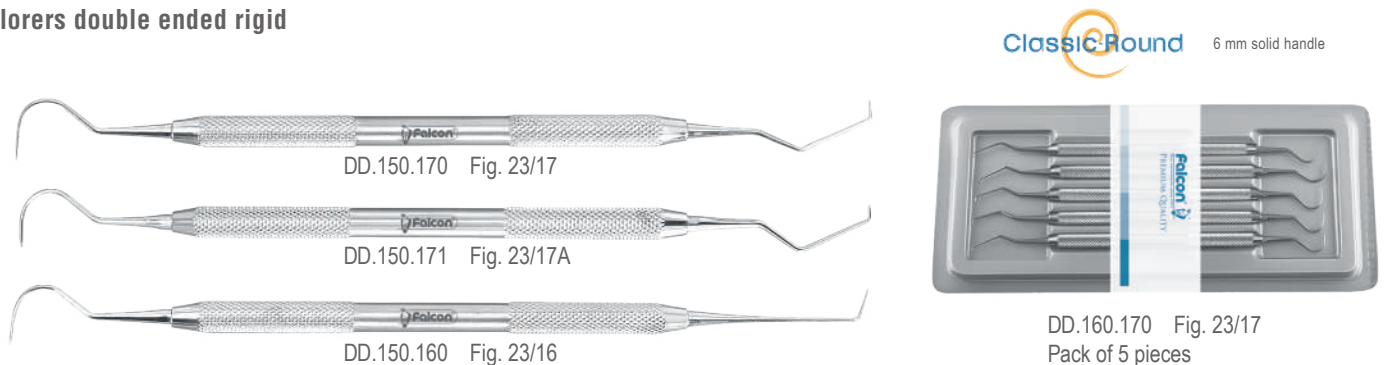

Explorers single ended flexible

Classic Round
5.5 mm solid handle



Pack of 5 pieces

- DD.211.060 Fig. 6
- DD.211.061 Fig. 6A
- DD.211.090 Fig. 9
- DD.211.230 Fig. 23
- DD.211.320 Fig. 32



Fig. 23
DD.201.230



Fig. 6
DD.201.060



Fig. 6A
DD.201.061



Fig. 8
DD.201.080



Fig. 8A
DD.201.081



Fig. 9
DD.201.090



Fig. 17
DD.201.170



Fig. 32
DD.201.320



Fig. 65
DD.201.650

Explorers single ended rigid

Probe single ended



Fig. 8
DD.350.081



Fig. 9
DD.350.091



Fig. 23
DD.350.231



Fig. 17
DD.350.171



Fig. 29
DD.350.291
Holst



Fig. 550B
DD.750.151
WHO

Explorers single ended rigid

Classic Round
6 mm solid handle



- DD.313.060 Fig. 6
- DD.313.090 Fig. 9
- DD.313.110 Fig. 11
- DD.313.160 Fig. 16
- DD.313.230 Fig. 23

Pack of 5 pieces



Fig. 23
DD.303.230



Fig. 2
DD.303.020



Fig. 3
DD.303.030



Fig. 3A
DD.303.031



Fig. 5
DD.303.050



Fig. 6
DD.303.060



Fig. 8
DD.303.080



Fig. 9
DD.303.090



Fig. 10
DD.303.100



Fig. 11
DD.303.110



Fig. 12
DD.303.120



Fig. 16
DD.303.160



Fig. 17
DD.303.170



Fig. 17A
DD.303.171

Explorers single ended flexible

Probe double ended

Classic-8
4.5 mm solid handle



Fig. 8
DD.397.080



Fig. 23
DD.397.230

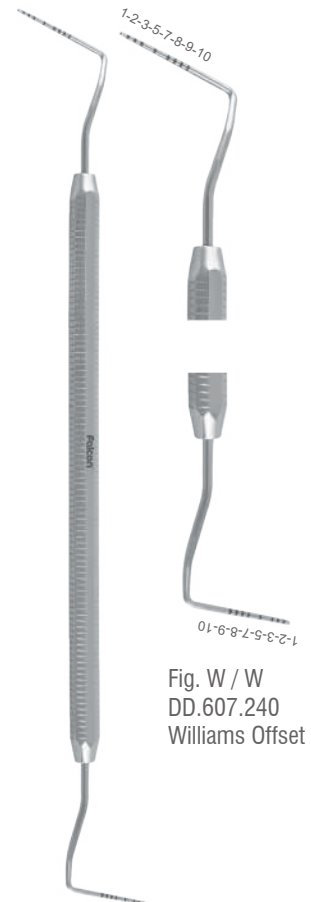
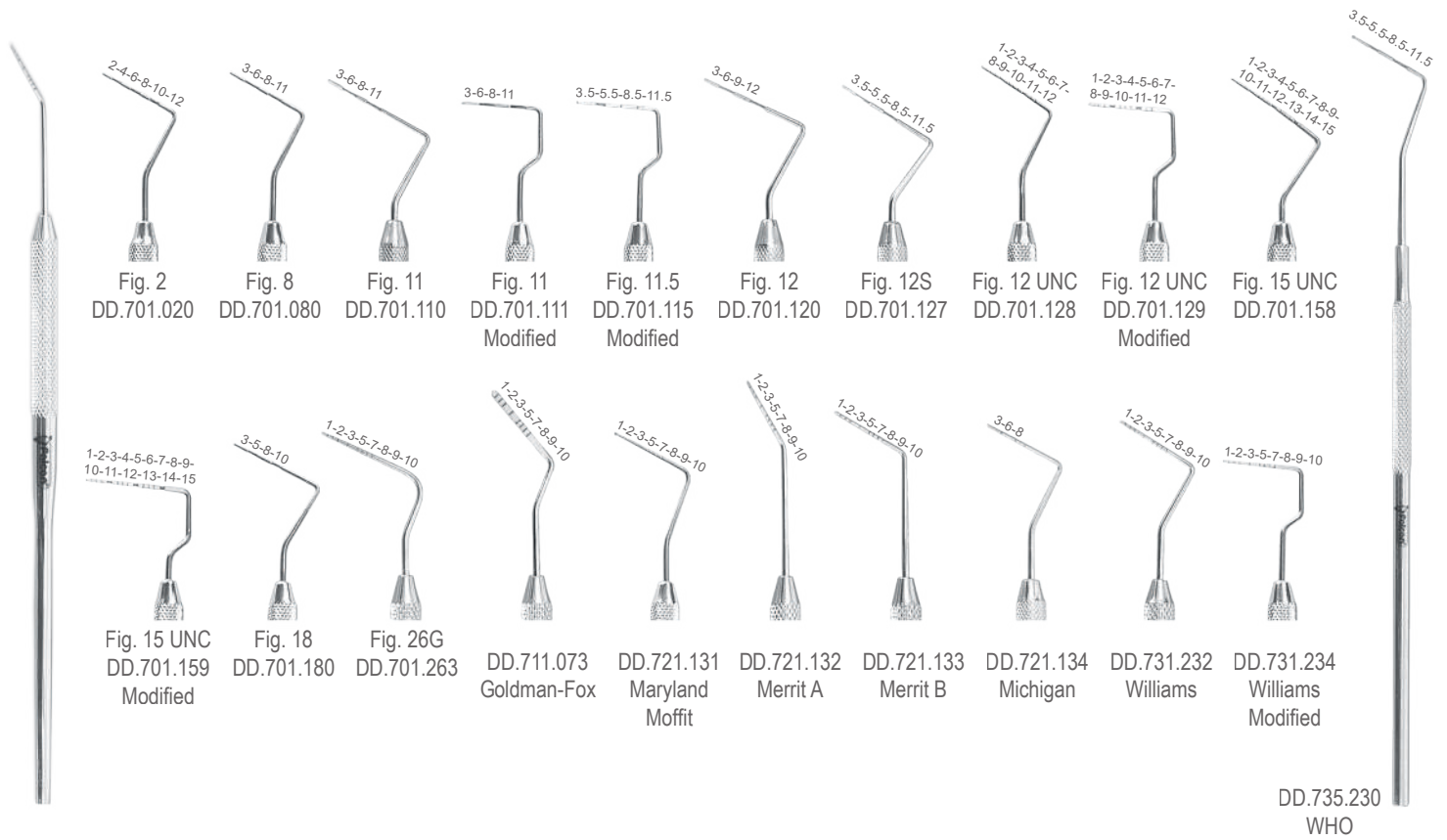

Fig. W / W
DD.607.240
Williams Offset

Periodontal probes



Color-Coded



Periodontal probes

Color-Coded

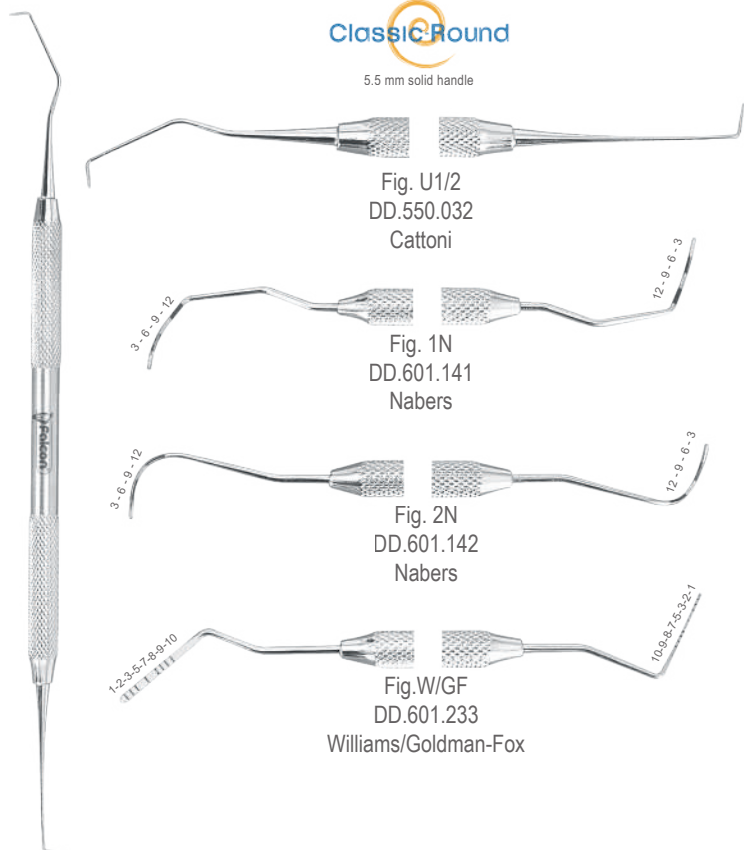

Expros (explorer-probe combination)

Color Coded

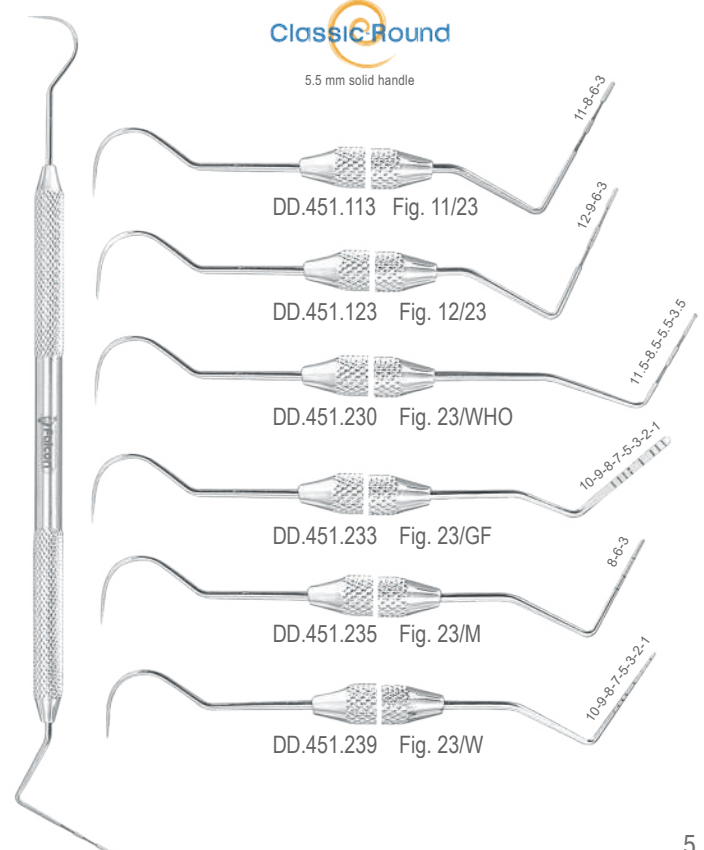

Diagnosics

Deluxe tweezers, 18-8 stainless steel



DD.900.150 College
150 mm



DD.901.150 Meriam
150 mm



DD.909.050 College
150 mm



DD.929.050 College Locking
150 mm



DD.934.010 Flagg
160 mm



DD.944.010 Meriam
160 mm



DD.978.130 Perry
130 mm



DD.979.130 Perry
130 mm

Deluxe tweezers titanium



DD.890.010 College
150 mm

Tweezers



DD.910.050 College



DD.930.050 College - Locking
150 mm



DD.945.010 Meriam



DD.980.130 Perry



DD.981.130 Perry

TOE (Turn Over Ends) Easy to clean



DD.911.050 College TOE



DD.946.010 Meriam TOE

Tweezers, Pack of 5



DD.909.055 College
DD.934.015 Flagg
DD.944.015 Meriam
Pack of 5 Pieces

Examination kits with single ended flexible explorer



Fig. 6A

DD.996.061
Contents
1 x DD.201.061
1 x DD.509.040
1 x DD.522.010
1 x DD.909.050



Fig. 9

DD.996.090
Contents
1 x DD.201.090
1 x DD.509.040
1 x DD.522.010
1 x DD.909.050



Fig. 23

DD.996.230
Contents
1 x DD.201.230
1 x DD.509.040
1 x DD.522.010
1 x DD.909.050

Examination kit with double ended explorer



DD.990.050
Contents
DD.540.010
DD.509.040
DD.197.050
DD.945.010

Examination kits with single ended rigid explorer



Fig. 6

With Fig. 4, 22 mm Mouth Mirror

DD.997.060
Contents
DD.522.010
DD.509.040
DD.303.060
DD.909.050



Fig. 9

DD.997.090
Contents
DD.522.010
DD.509.040
DD.303.090
DD.909.050



Fig. 23

DD.997.230
Contents
DD.522.010
DD.509.040
DD.303.230
DD.909.050

With Fig. 5, 24 mm Mouth Mirror

DD.997.062
Contents
DD.522.010
DD.509.050
DD.303.060
DD.909.050

DD.997.092
Contents
DD.522.010
DD.509.050
DD.303.090
DD.909.050

DD.997.232
Contents
DD.522.010
DD.509.050
DD.303.230
DD.909.050

Photography

Intraoral photographic mirrors
Made of stainless steel

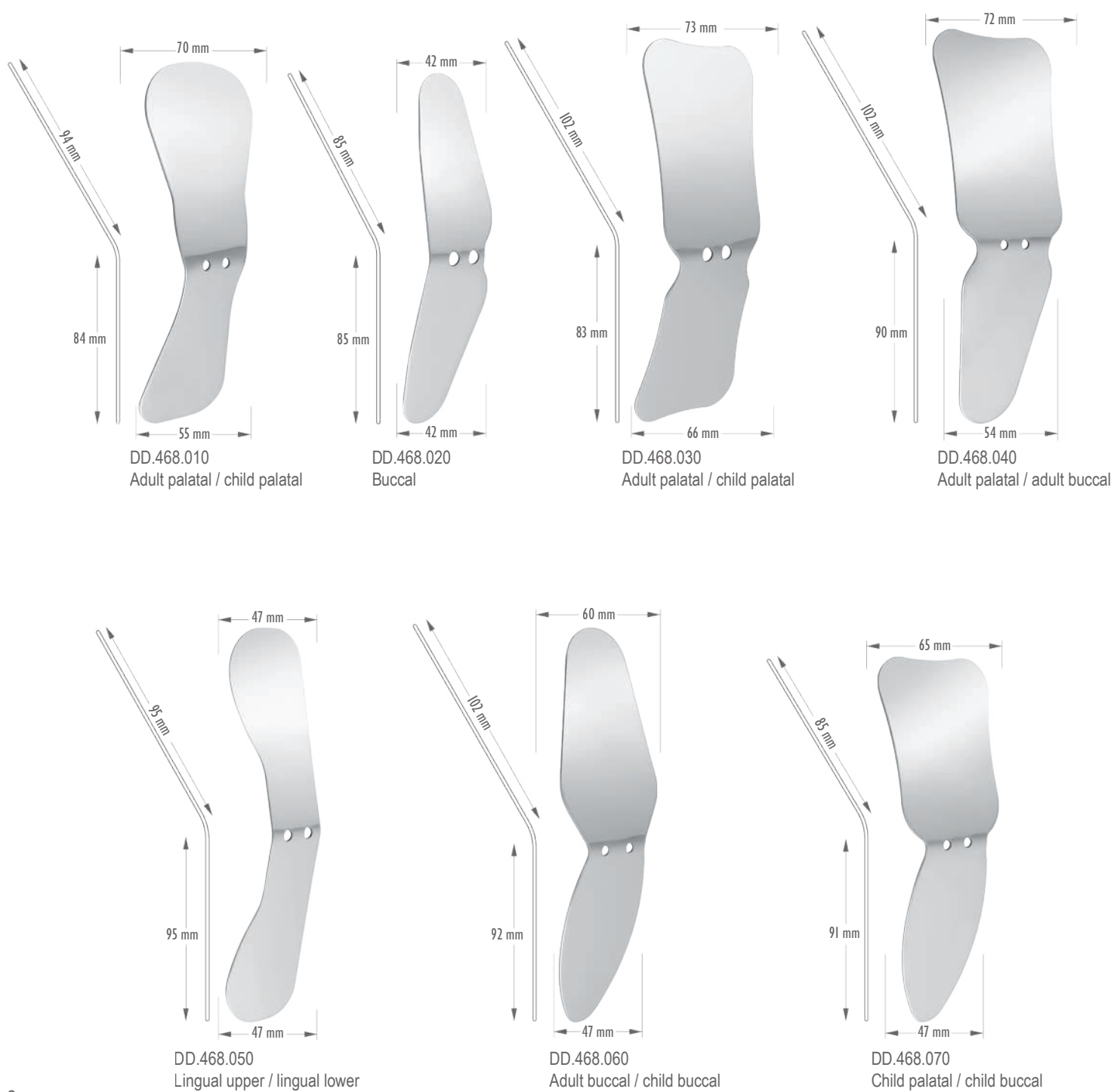

Intraoral photographic mirrors



Double sided front surface
No double reflection
Chromium coated glass
Provides sharp images



DD.470.030
Palatal-Adult



DD.470.031
Palatal-Adult Large



DD.470.040
Palatal-Child

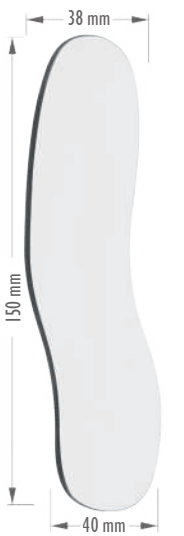

DD.470.011
Buccal - Small



DD.470.010
Buccal



DD.470.020
Lingual

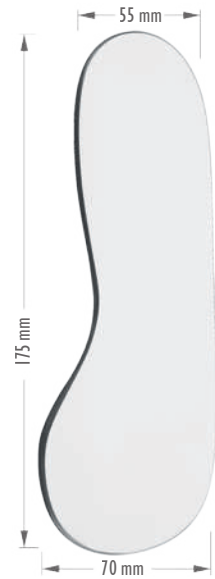

DD.470.021
Lingual - Large

Sterilization cassette for photographic mirrors

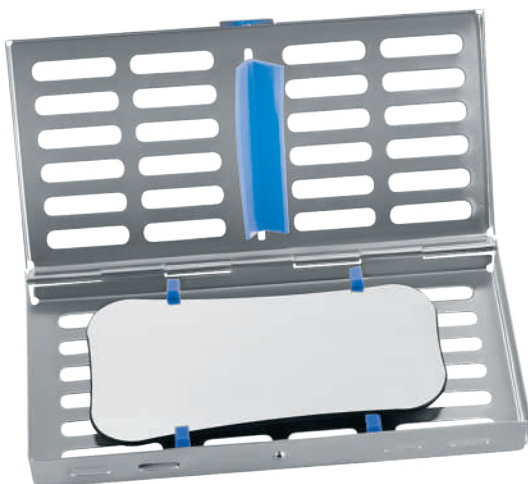

DZ.085.090
Suitable for all Intraoral photographic mirrors

Handle for photographic mirrors



Designed by
Falcon[®]

DD.472.000
Stainless Steel

Contrastors



Autoclavable



DD.475.030T
Anterior-Small



DD.475.040T
Anterior-Large



DD.475.050T
Anterior



DD.475.060T
Posterior



DD.475.070T
Occlusal-Small



DD.475.080T
Occlusal-Medium



DD.475.090T
Occlusal-Large

Large mirrors with handle



For intraoral photography
Bendable at any angle
Chrome front surface
No double reflection
Autoclavable

DD.471.010 Ø 38mm
DD.471.020 Ø 50mm

Photo cheek retractors



Autoclavable



DS.434.010 Small
DS.434.020 Large

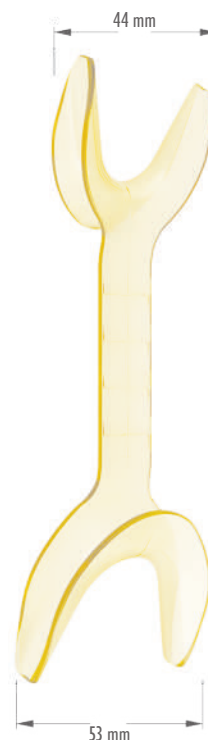

Photo cheek and lip retractors



DS.435.010B
Simplex
105 mm



DS.435.000B
Simplex 1/2 CUT
105 mm
Pair (Left and Right)
Ends trimmed for easier occlusal view



DS.435.020B
Simplex-Falcon
110 mm



DS.435.030B
Simplex-Falcon
170 mm
V-Shape, excellent for
pulling back the cheek



DS.437.010B
Falcon
170 mm
Lip retractor, excellent
for occlusal photos



DS.435.010
Simplex
105 mm



DS.435.000
Simplex 1/2 CUT
105 mm
Pair (Left and Right)



DS.435.020
Simplex-Falcon
110 mm



DS.435.030
Simplex-Falcon
170 mm



DS.437.010
Falcon
170 mm

Gracey Curettes

Easy
COLOR

- Ergonomic, large diameter silicone handle for better grip
- Rigid pattern, thicker tips than standard Gracey

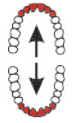

Anterior teeth



Fig. 1/2
DP.148.021 Mini
DP.156.021 Rigid
DP.160.021 Standard
Grey

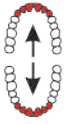

Anterior teeth

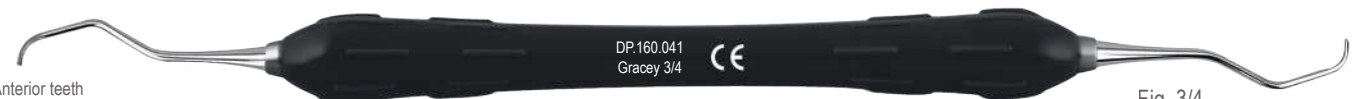
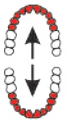

Fig. 3/4
DP.148.041 Mini
DP.156.041 Rigid
DP.160.041 Standard
Black



Anterior and Premolars



Fig. 5/6
DP.148.061 Mini
DP.156.061 Rigid
DP.160.061 Standard
Yellow

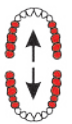

Premolars and Molars



Fig. 7/8
DP.148.081 Mini
DP.156.081 Rigid
DP.160.081 Standard
Green

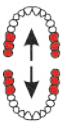

Molars buccal and lingual surfaces



Fig. 9/10
DP.148.101 Mini
DP.156.101 Rigid
DP.160.101 Standard
Red

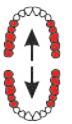

Posterior mesial surfaces



Fig. 11/12
DP.148.111 Mini
DP.156.111 Rigid
DP.160.111 Standard
Orange

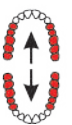

Posterior distal surfaces



Fig. 13/14
DP.148.141 Mini
DP.156.141 Rigid
DP.160.141 Standard
Blue

Gracey Curettes Sets

Easy
COLOR

- Ergonomic, large diameter silicone handle for better grip
- Rigid pattern, thicker tips than standard Gracey



DP.148.000 Mini
Set of 7 pieces



DP.156.000 Rigid
Set of 7 pieces



DP.999.011 Standard
Set of 7 pieces

Curettes

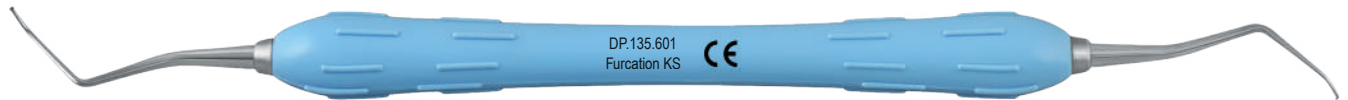

Fig. 259-260
DP.135.601 Furcation KS

Scalers



Fig. 204S
DP.763.021



Fig. 6/7
DP.786.071 Hygienist

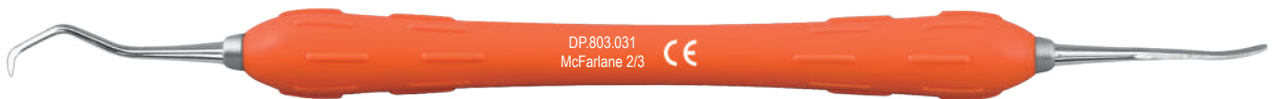

Fig. 2/3
DP.803.031 McFarlane



Fig. 4/5
DP.803.051 McFarlane

Periodontal

Gracey Curettes

○ CLASSIC-LITE 10 mm hollow handle



● Classic-Round 6 mm solid handle



● Classic-8 5.5 mm solid handle

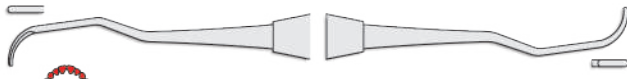



Fig. 1/2
Anterior teeth

DP.160.025	Hollow	○
DP.160.020	Round	●
DP.160.027	Octagonal	●

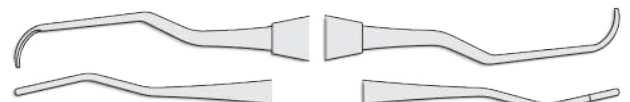

Fig. 11/12
Posterior mesial surfaces

DP.160.115	Hollow	○
DP.160.110	Round	●
DP.160.117	Octagonal	●



Fig. 3/4
Anterior teeth

DP.160.045	Hollow	○
DP.160.040	Round	●
DP.160.047	Octagonal	●

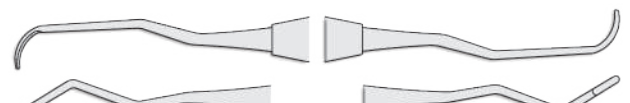

Fig. 13/14
Posterior distal surfaces

DP.160.145	Hollow	○
DP.160.140	Round	●
DP.160.147	Octagonal	●

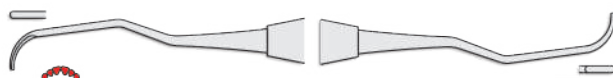

Fig. 5/6
Anterior and Premolars

DP.160.065	Hollow	○
DP.160.060	Round	●
DP.160.067	Octagonal	●

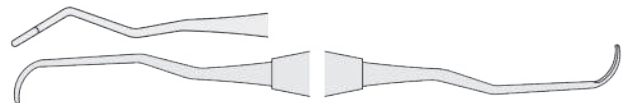



Fig. 7/8
Premolars and Molars

DP.160.085	Hollow	○
DP.160.080	Round	●
DP.160.087	Octagonal	●



Fig. 15/16
Posterior mesial surfaces

DP.160.165	Hollow	○
DP.160.160	Round	●
DP.160.167	Octagonal	●

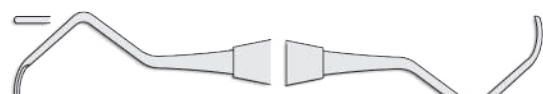

Fig. 9/10
Molars buccal and lingual surfaces

DP.160.105	Hollow	○
DP.160.100	Round	●
DP.160.107	Octagonal	●



Fig. 17/18
Posterior distal surfaces

DP.160.185	Hollow	○
DP.160.180	Round	●
DP.160.187	Octagonal	●

Gracey Curettes Sets



DP.999.015 Standard
Set of 7 pieces



DP.999.010 Standard
Set of 7 pieces

Columbia Universal Curettes

○ CLASSIC-LITE
10 mm hollow handle

● CLASSIC-ROUND
6 mm solid handle

● CLASSIC-8
5.5 mm solid handle



Fig. 4R/4L DP.128.045 Hollow ○
DP.128.040 Round ●
DP.128.047 Octagonal ●



Fig. 2R/2L DP.128.025 Hollow ○
DP.128.020 Round ●
DP.128.027 Octagonal ●

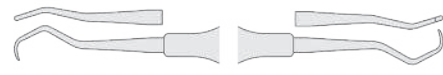

Fig. 13/14 DP.125.145 Hollow ○
DP.125.140 Round ●
DP.125.147 Octagonal ●

Hoes

With tungsten carbide tips

○ CLASSIC-LITE
10 mm hollow handle



Fig. 6/7 DP.375.075 McFarlane



Fig. 8/9 DP.375.095 McFarlane

Hoes

○ CLASSIC-LITE
10 mm hollow handle

● CLASSIC-8
5.5 mm solid handle



Goldman-Fox

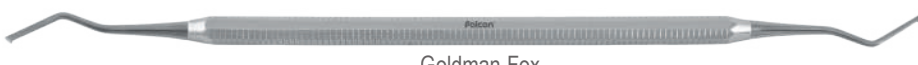

Goldman-Fox

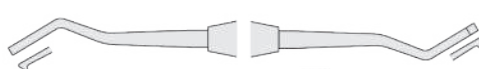

DP.365.055 ○
DP.365.057 ●

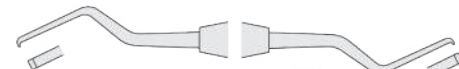

DP.365.065 ○
DP.365.067 ●

Scalers

● **Classic Round** 6 mm solid handle



○ **CLASSIC-LITE** 10 mm hollow handle

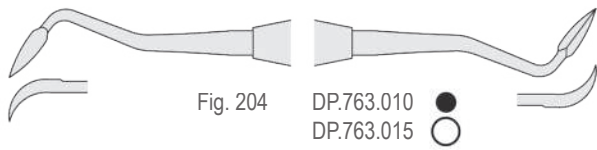

Fig. 204 DP.763.010 ●
DP.763.015 ○

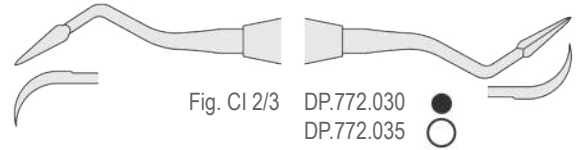

Fig. CI 2/3 DP.772.030 ●
DP.772.035 ○

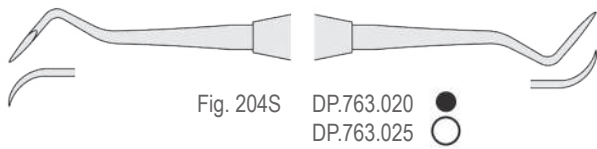

Fig. 204S DP.763.020 ●
DP.763.025 ○

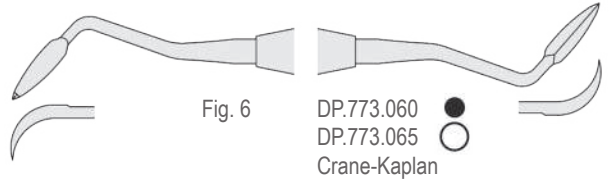

Fig. 6 DP.773.060 ●
DP.773.065 ○
Crane-Kaplan

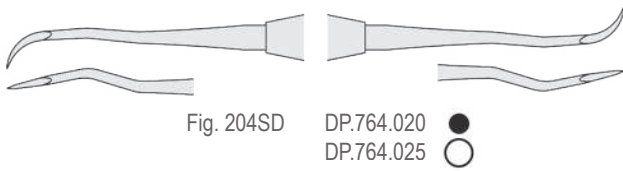

Fig. 204SD DP.764.020 ●
DP.764.025 ○

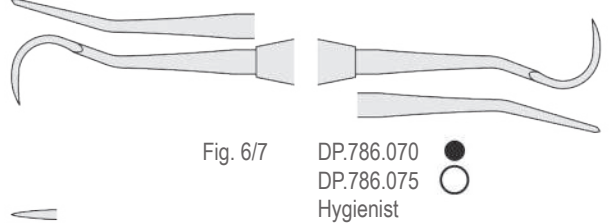

Fig. 6/7 DP.786.070 ●
DP.786.075 ○
Hygienist

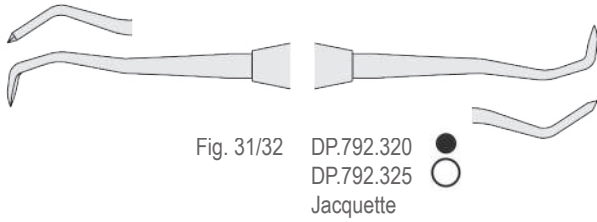

Fig. 31/32 DP.792.320 ●
DP.792.325 ○
Jacquette

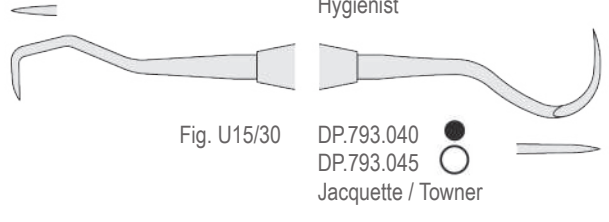

Fig. U15/30 DP.793.040 ●
DP.793.045 ○
Jacquette / Towner

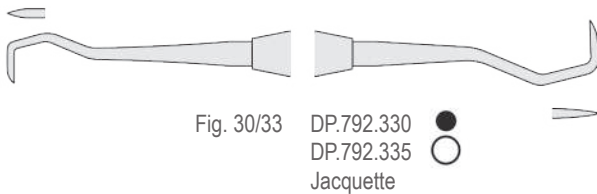

Fig. 30/33 DP.792.330 ●
DP.792.335 ○
Jacquette

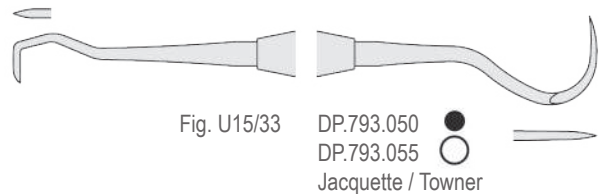

Fig. U15/33 DP.793.050 ●
DP.793.055 ○
Jacquette / Towner

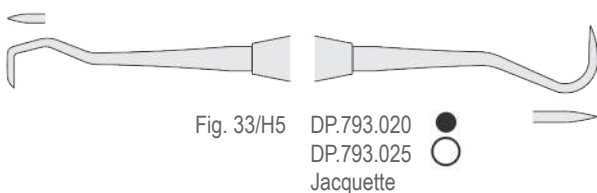

Fig. 33/H5 DP.793.020 ●
DP.793.025 ○
Jacquette

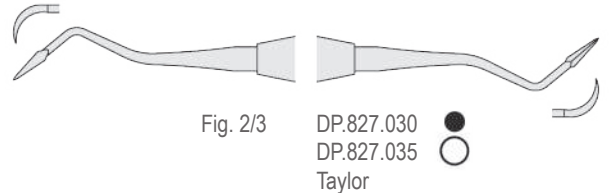

Fig. 2/3 DP.827.030 ●
DP.827.035 ○
Taylor

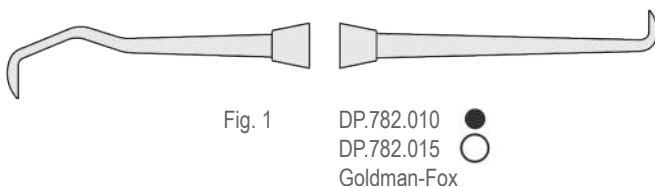

Fig. 1 DP.782.010 ●
DP.782.015 ○
Goldman-Fox

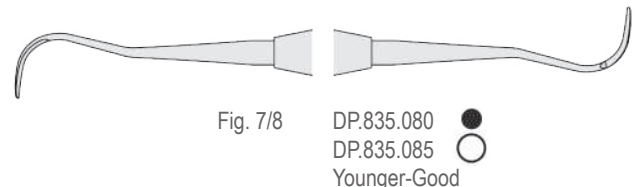
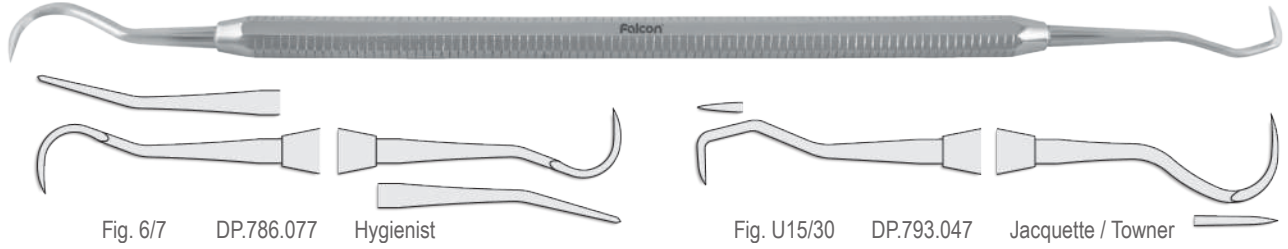

Fig. 7/8 DP.835.080 ●
DP.835.085 ○
Younger-Good

Scalers

● **Classic-8**
5.5 mm solid handle



Scalers

● **Classic-8**
5.5 mm solid handle



Hygienist

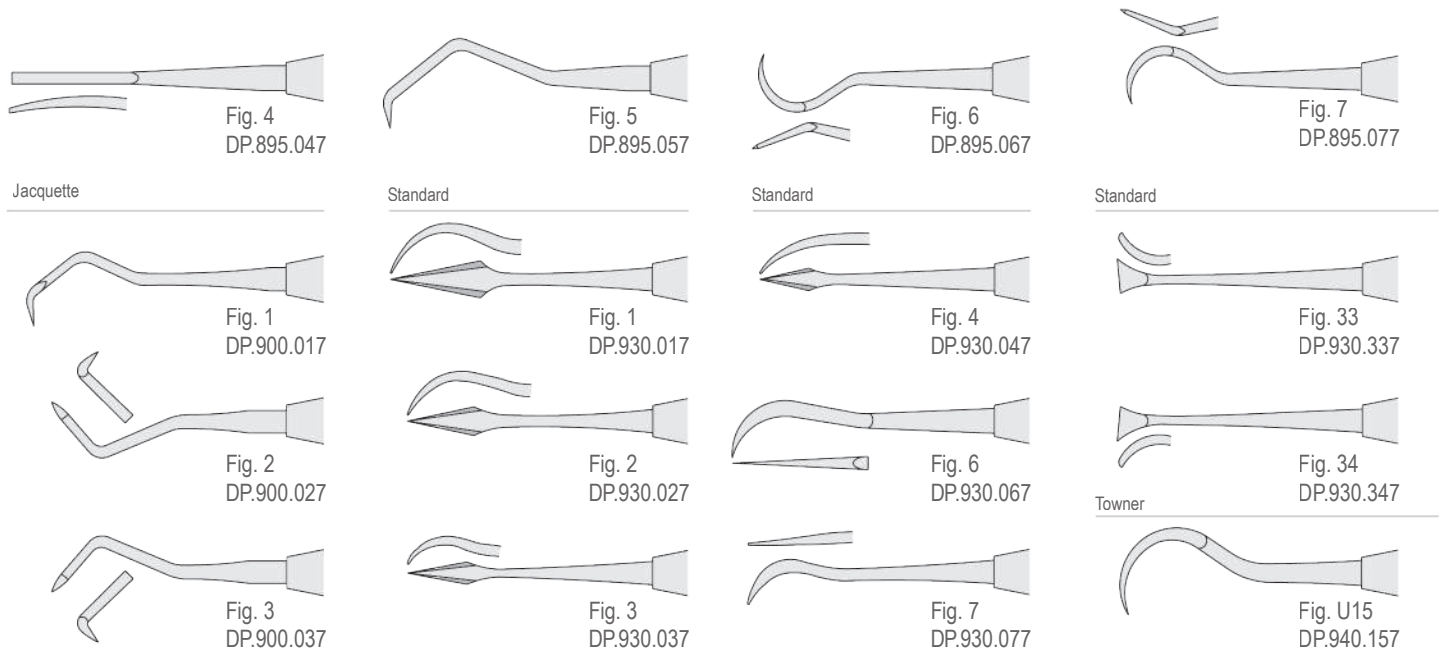

Scalers

○ **CLASSIC-LITE**
9.5 mm hollow handle

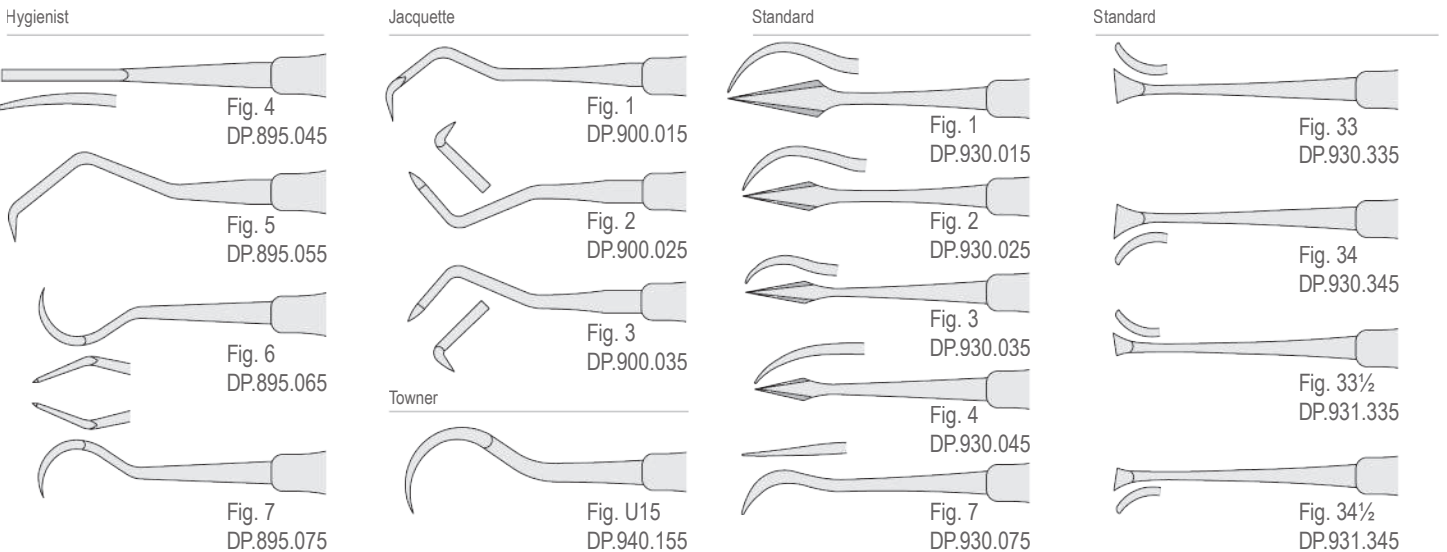

Endodontics

Endodontic Explorers

Easy COLOR

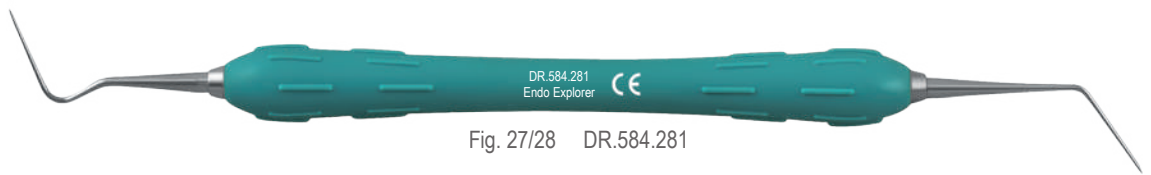

SOFT LINE INSTRUMENTS
soft and sure grip



CLASSIC-LITE
8 mm hollow handle

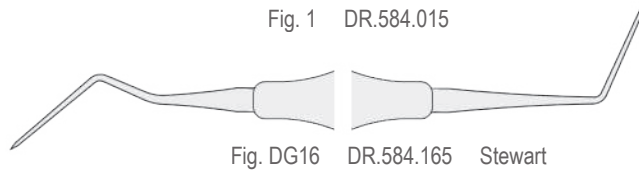

Classic-8
4.5 mm solid handle

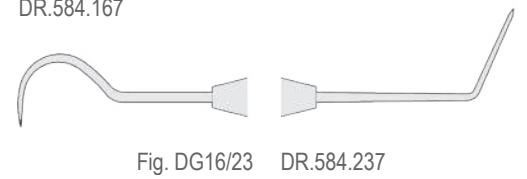
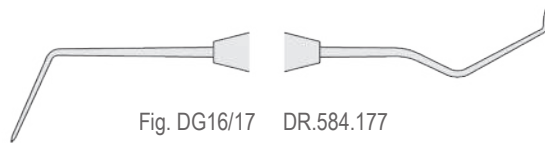
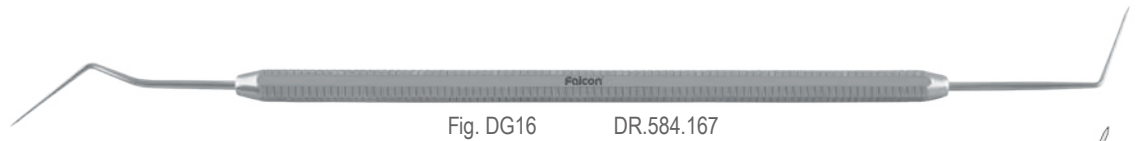

Classic Round
6 mm solid handle

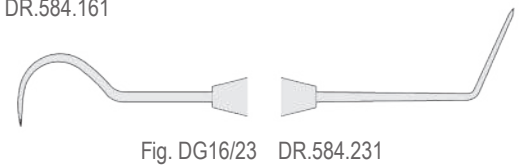
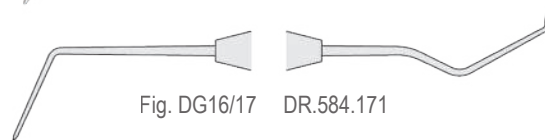

Endodontic Excavators

Classic Round
6 mm solid handle

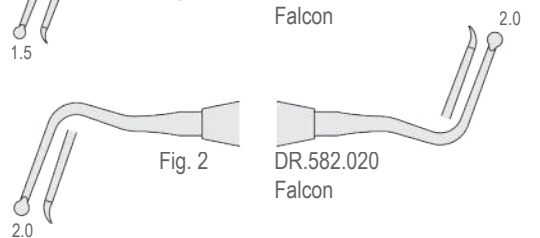
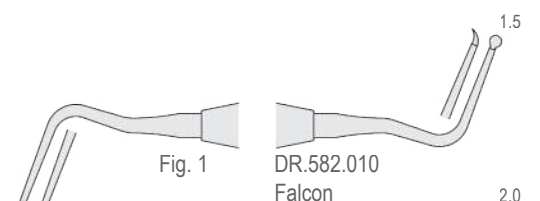
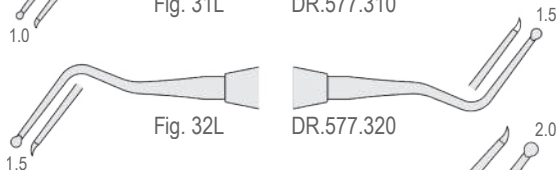
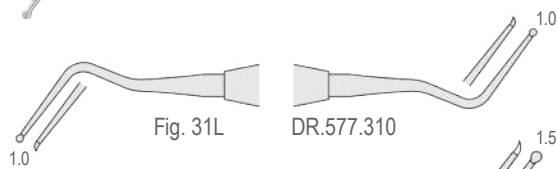

Endodontic Excavators

SOFT LINE INSTRUMENTS
soft and sure grip

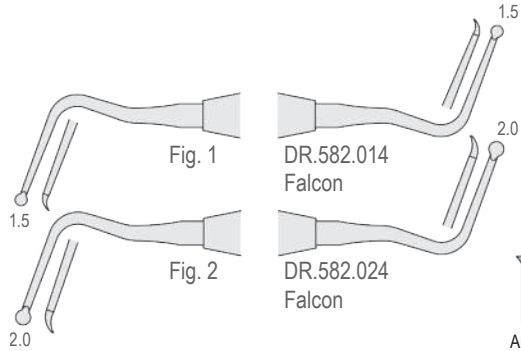

Fig. 1

DR.582.014
Falcon

Fig. 2

DR.582.024
Falcon



Hand Pluggers

Easy COLOR



Fig. 41-42 DR.591.421

NiTi Hand Pluggers

SOFT LINE INSTRUMENTS
soft and sure grip



Fig. 1 DR.590.014 Falcon

Fig. 2 DR.590.024 Falcon



Hand Pluggers

SOFT LINE INSTRUMENTS
soft and sure grip

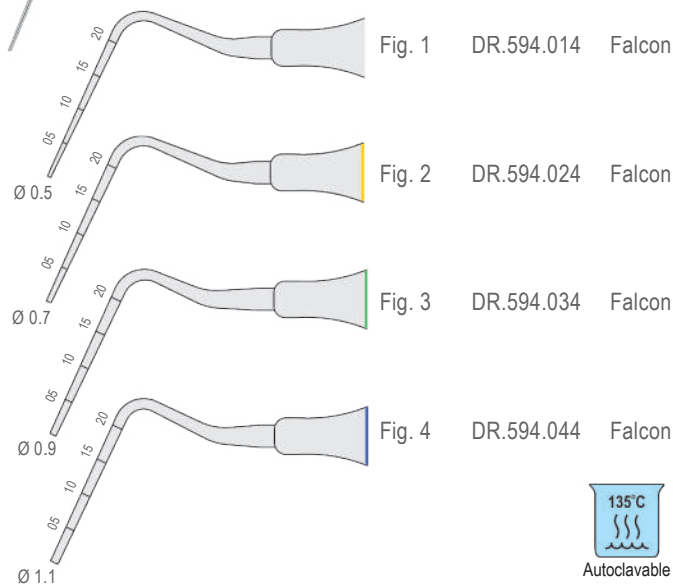

Fig. 1 DR.594.014 Falcon

Fig. 2 DR.594.024 Falcon

Fig. 3 DR.594.034 Falcon

Fig. 4 DR.594.044 Falcon



Pluggers / Heat Carriers

CLASSIC-LITE

8 mm hollow handle

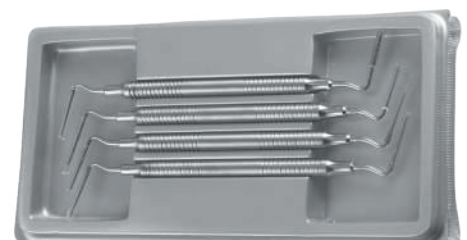

Fig. 1/1 DR.589.015

Fig. 1/2 DR.589.025

Fig. 2/3 DR.589.035

Fig. 2/4 DR.589.045



DR.589.005 Set of 4 pieces

Hand Spreaders

SOFT LINE INSTRUMENTS
soft and sure grip

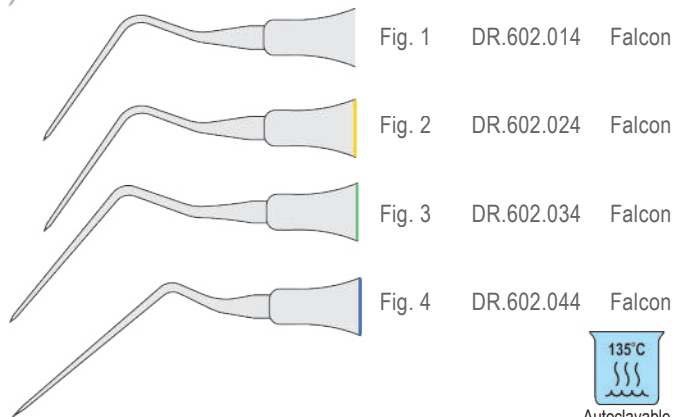

Fig. 1 DR.602.014 Falcon

Fig. 2 DR.602.024 Falcon

Fig. 3 DR.602.034 Falcon

Fig. 4 DR.602.044 Falcon



Endodontics

Hand Pluggers

Classic-Round

6 mm solid handle

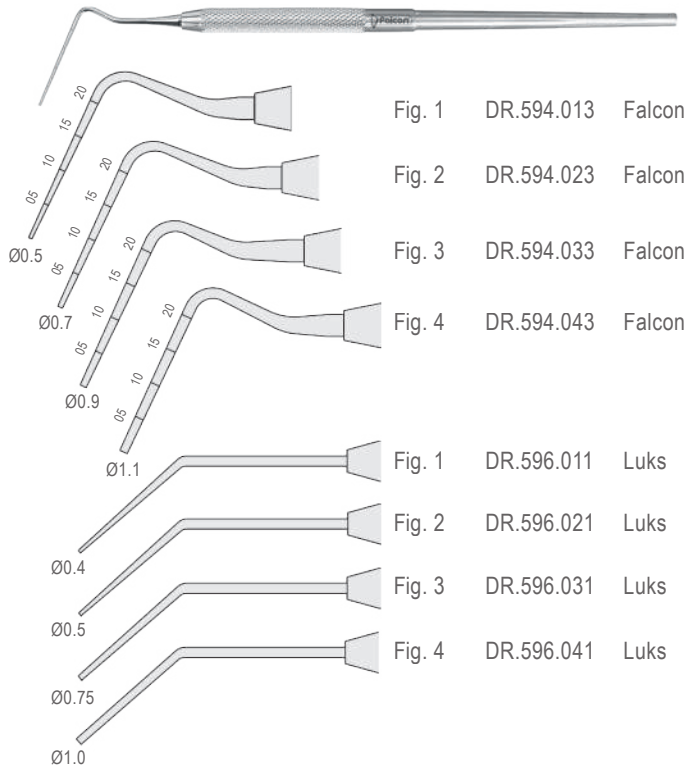

- Fig. 1 DR.594.013 Falcon
- Fig. 2 DR.594.023 Falcon
- Fig. 3 DR.594.033 Falcon
- Fig. 4 DR.594.043 Falcon
- Fig. 1 DR.596.011 Luks
- Fig. 2 DR.596.021 Luks
- Fig. 3 DR.596.031 Luks
- Fig. 4 DR.596.041 Luks

Hand Spreaders

Classic-Round

6 mm solid handle

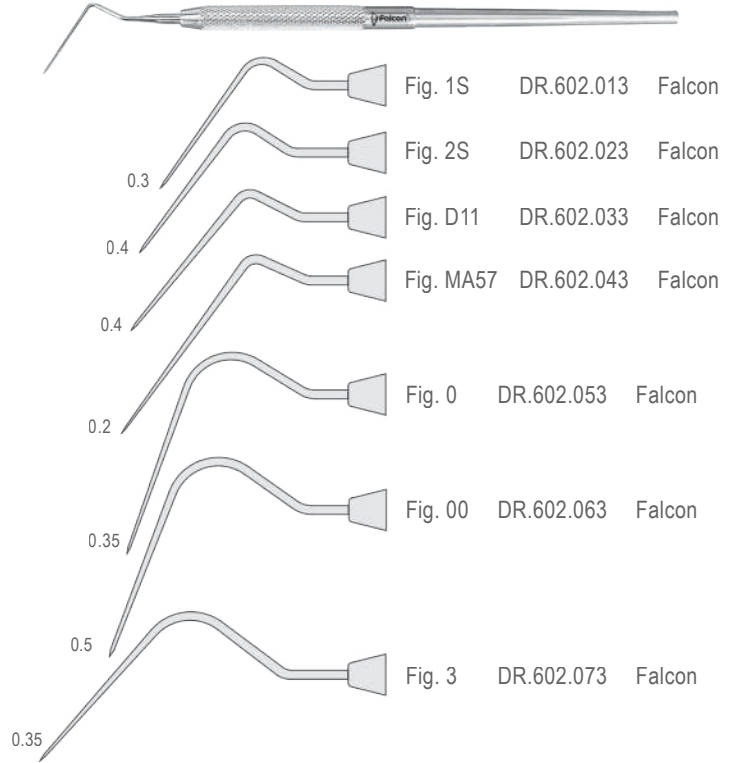

- Fig. 1S DR.602.013 Falcon
- Fig. 2S DR.602.023 Falcon
- Fig. D11 DR.602.033 Falcon
- Fig. MA57 DR.602.043 Falcon
- Fig. 0 DR.602.053 Falcon
- Fig. 00 DR.602.063 Falcon
- Fig. 3 DR.602.073 Falcon

Hand Pluggers

Classic-8

5.5 mm solid handle

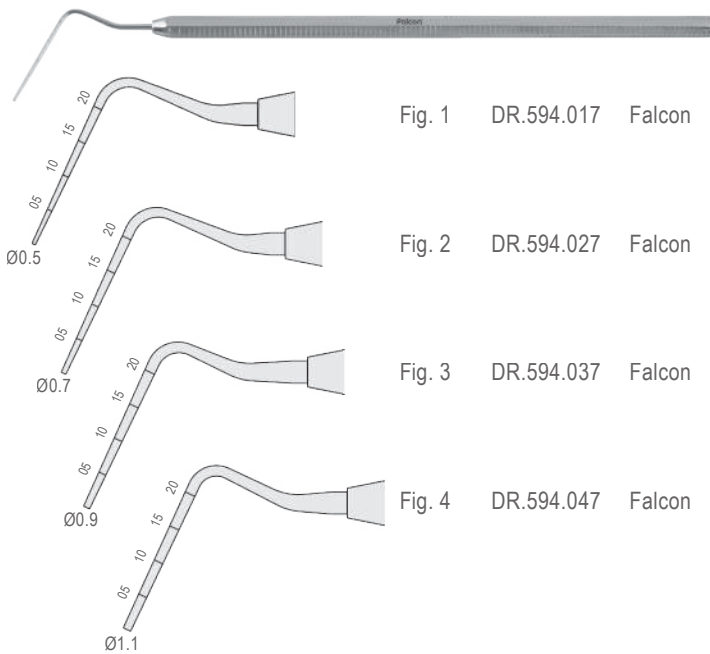

- Fig. 1 DR.594.017 Falcon
- Fig. 2 DR.594.027 Falcon
- Fig. 3 DR.594.037 Falcon
- Fig. 4 DR.594.047 Falcon

Hand Spreaders

Classic-8

5.5 mm solid handle

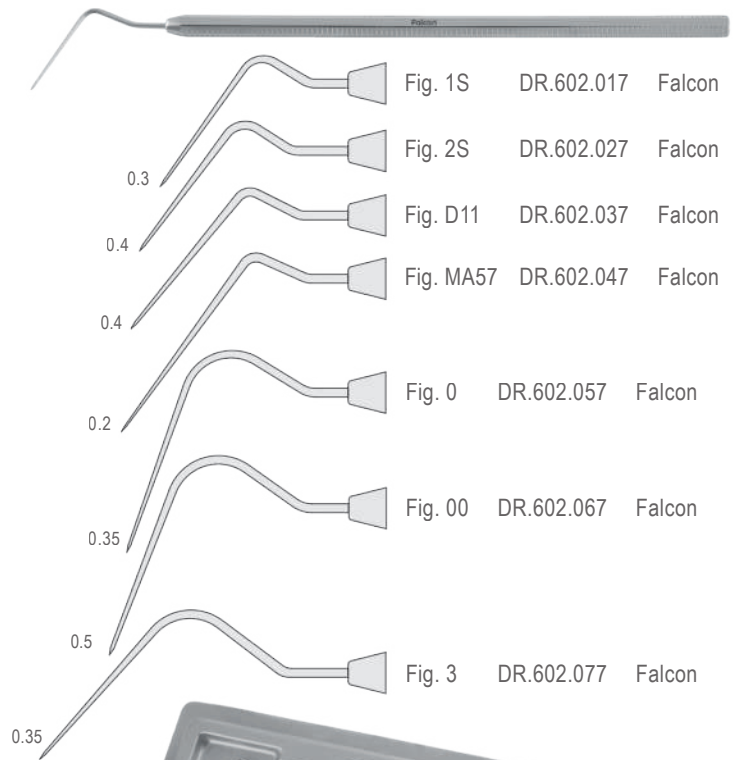

- Fig. 1S DR.602.017 Falcon
- Fig. 2S DR.602.027 Falcon
- Fig. D11 DR.602.037 Falcon
- Fig. MA57 DR.602.047 Falcon
- Fig. 0 DR.602.057 Falcon
- Fig. 00 DR.602.067 Falcon
- Fig. 3 DR.602.077 Falcon



DR.594.007 Set of 4 pcs



DR.602.007 Set of 4 pcs (Fig. 1S, 2S, D11, MA57)

Micro Endodontic Pluggers / Burnishers

SOFT LINE INSTRUMENTS
soft and sure grip

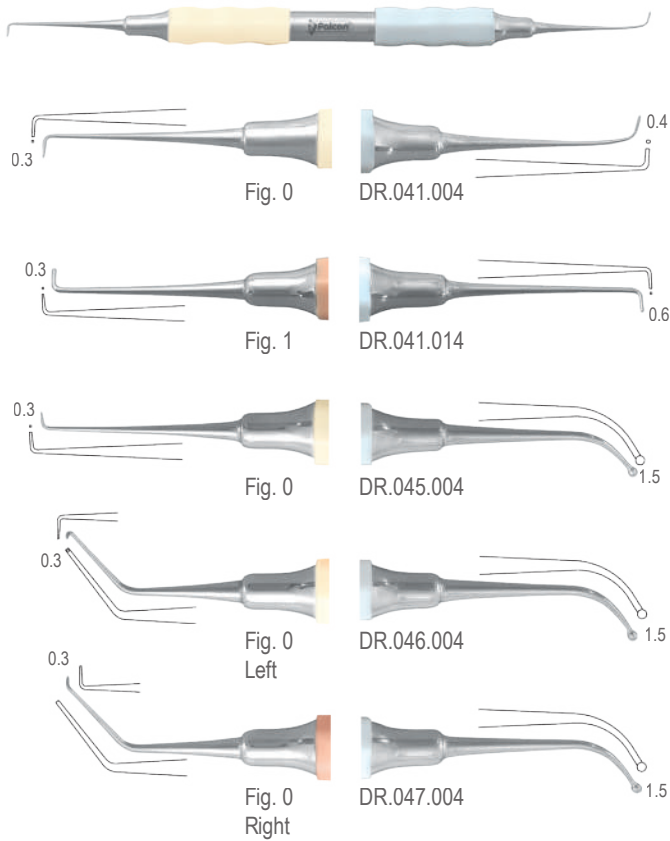

Perforation Repair Instruments

SOFT LINE INSTRUMENTS
soft and sure grip

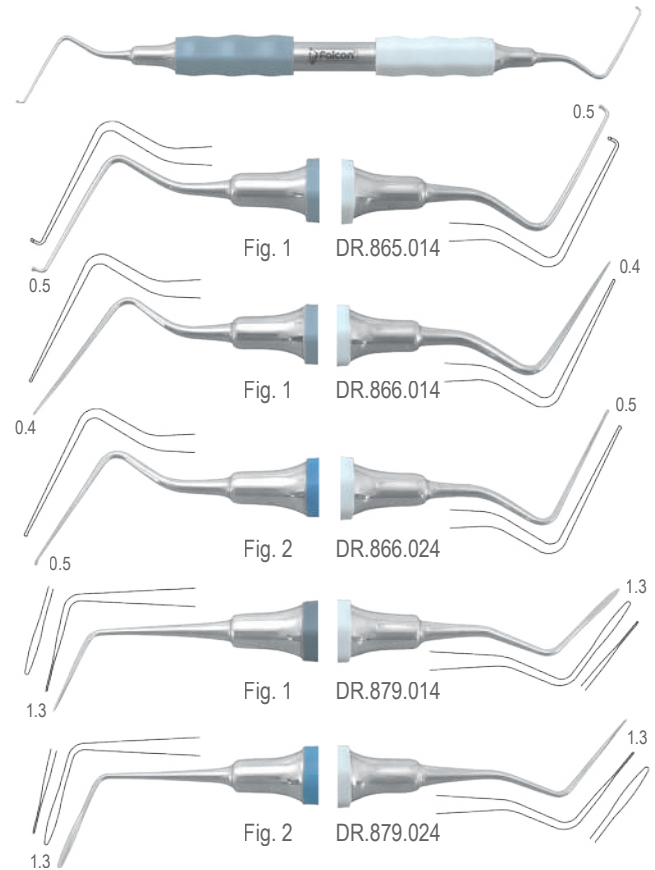

Micro Endodontic Pluggers / Burnishers

SOFT LINE INSTRUMENTS
soft and sure grip

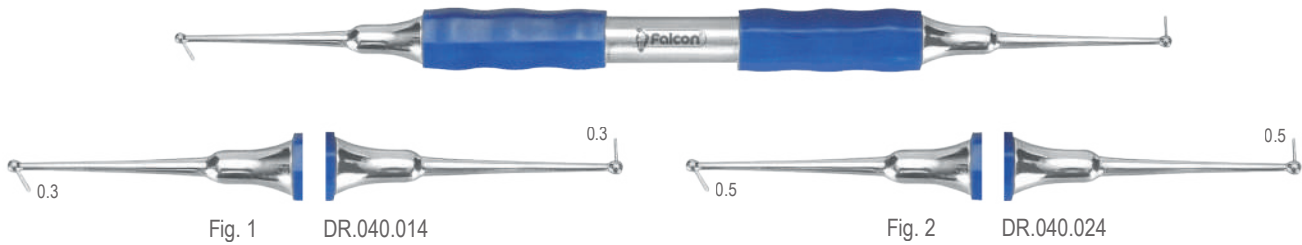

Endodontic Retractors

SOFT LINE INSTRUMENTS
soft and sure grip

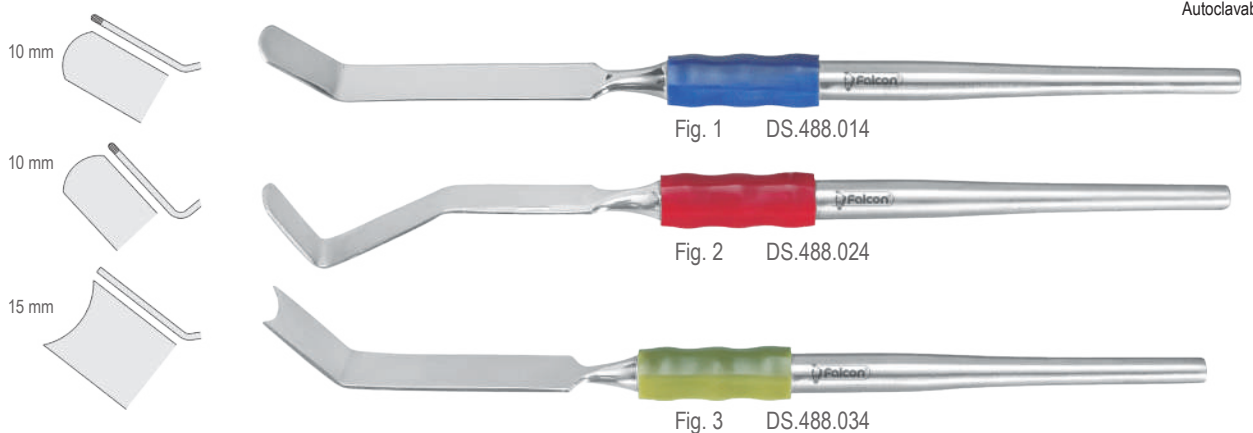

Endodontics

Endodontic Curettes

SOFT LINE INSTRUMENTS
soft and sure grip



Fig. 2/4 DS.126.044
Molt

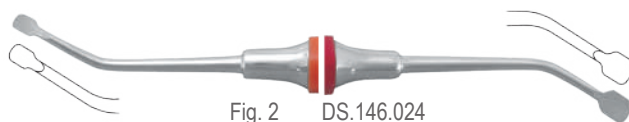

Fig. 2 DS.146.024
Ruddle
Right

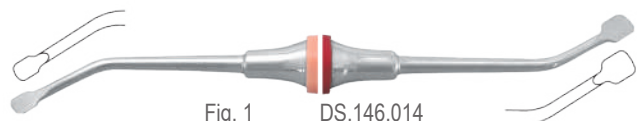

Fig. 1 DS.146.014
Ruddle
Left

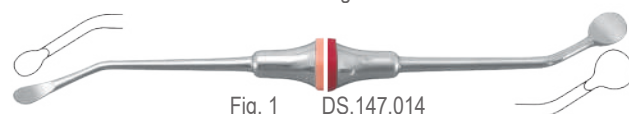

Fig. 1 DS.147.014
Ruddle
Left

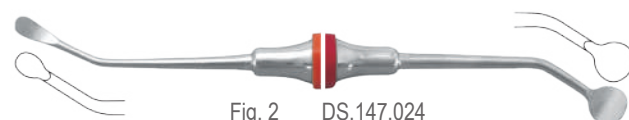
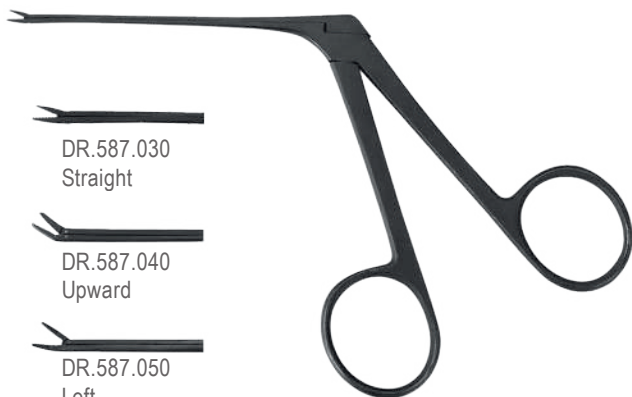

Fig. 2 DS.147.024
Ruddle
Right

Endodontic Forceps



DR.587.030
Straight

DR.587.040
Upward

DR.587.050
Left

DR.587.060
Right

Endodontic Forceps For Silver Points



DR.587.130
125 mm

Endodontic Tweezers



DR.586.020
150 mm

Splinter Forceps

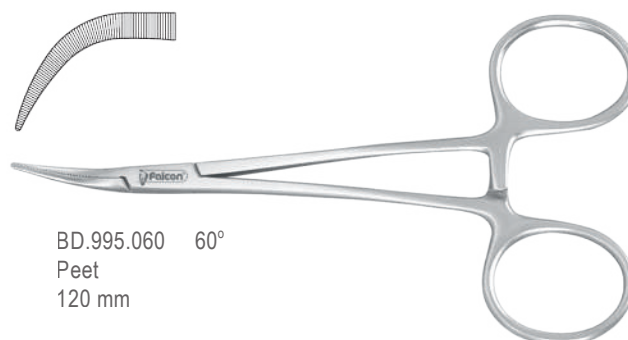

BD.995.060 60°
Peet
120 mm

Endodontic Instruments Holder



DR.2999.00

Endo Cleaner



DZ.572.010



Spare Sponges
DZ.572.050
Pack of 50 pieces
Ø 55 mm x 5 mm



Spare Sponges
DZ.572.100
Pack of 50 pieces
Ø 55 mm x 10 mm

Endometer Ultima



DZ.573.020
Disposable Foams
Pack of 10 pieces

DZ.573.000
Contents:
1 x Endo-Ruler (laser etched)
10 x Disposable medicament cups
3 x Disposable foams

Spares
DZ.573.010
Disposable medicament cups
Pack of 50 pieces

Endo / Implant Tray Stainless Steel With Cover



DZ.556.000
205 x 100 x 25 mm

Endometer Laser Etched

DZ.575.010
Endometer



DZ.575.000
Endometer Petite



Endo And Gutta Box



DZ.560.010

Aluminum Endometer



DZ.574.010

Aluminum Boxes For Endodontic Instruments And Gutta Percha



DZ.565.010
Silver

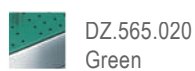

DZ.565.020
Green

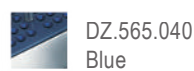

DZ.565.040
Blue

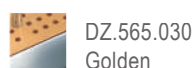

DZ.565.030
Golden

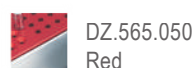

DZ.565.050
Red



DZ.565.060
Silver

Compo-Art

Instruments For Aesthetic Restorations



DR.400.011
Super flexible spatula for application and modeling of composite material



DR.400.021
Super flexible twisted spatula for application and modeling of composite in hard to reach areas



DR.400.031
Round tipped condenser for modeling of composite



DR.400.041
Super flexible spatula for application and modeling of composite material



DR.400.051
Sharp pointed instrument to place fissures, grooves and pits creating the ideal occlusal anatomy



DR.400.061
Sharp instrument for the removal of excess composite and bonding material



DR.400.071
Instrument to determine the vertical and horizontal thickness of composite layers on the anterior restorations



DR.400.081
Instrument to determine the vertical and horizontal thickness of composite layers on the posterior restorations

Compo-Art

Instruments For Aesthetic Restorations



DR.400.091
Universal instruments for restoration in posterior



DR.400.101
Universal instruments for direct veneering in anterior

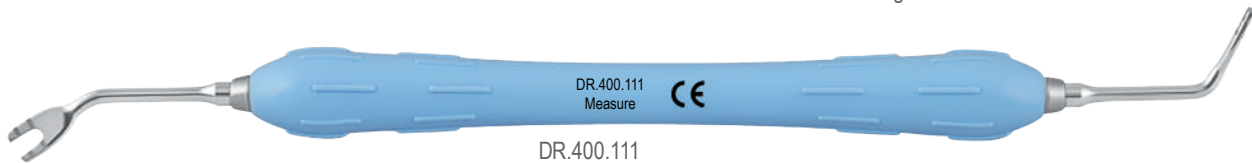

DR.400.111
Measuring instrument cuspids

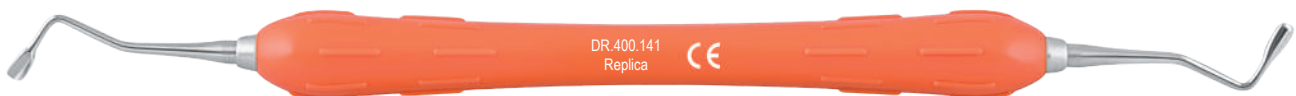

DR.400.141
Occlusal modeling of posterior teeth



DR.400.151
Contact Point Premolar

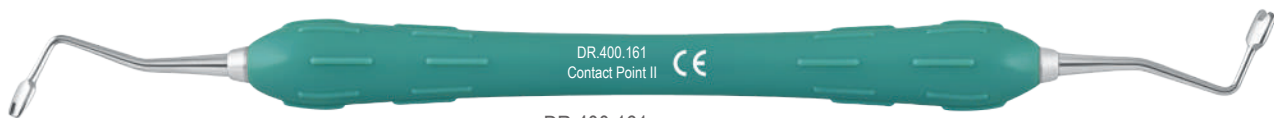

DR.400.161
Contact Point Molar



DR.401.021
Fig. B Goldfogel



DR.400.121
Composite modelling instrument



DR.400.131
Condenser and rigid applicator

Compo-fill
Instruments

Easy
COLOR

- Ultra Lightweight
- Non-stick tips
- TIN coated



Pluggers



Fig. 5A DR.051.051



Fig. 3 DR.073.031 Hollenback



Fig. 1 DR.091.011 Super



Fig. OT DR.092.001 Tanner



Fig. 0/1 DR.063.011 Black



Fig. 1/2 DR.063.021 Black

Burnishers



Fig. 21B DR.111.211 Acorn/ Wescott



Fig. 1 DR.121.011 Contact Former



Fig. 2 DR.121.021 Contact Former



Fig. 2 DR.139.021 Ladmore



Fig. 3 DR.139.031 Ladmore



Fig. 27/29 DR.148.041 White



Fig. 1 DR.100.011



Fig. 1L DR.101.011



Fig. 155 DR.135.551

Filling Instruments

Compo-fill
Instruments



Easy
COLOR



Fig. 156(A6) DR.426.561



Fig. 8A DR.431.081



Fig. 1 DR.445.011 Boghosian



Fig. 2 DR.445.021 Boghosian

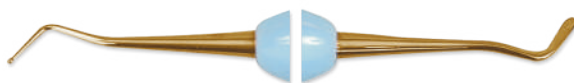

Fig. 1 DR.451.011 Falcon



Fig. 2 DR.451.021 Falcon



Fig. 1 DR.457.011 Goldstein



Fig. 2 DR.457.021 Goldstein



Fig. 3 DR.457.031 Goldstein



Fig. 4 DR.457.041 Goldstein



Fig. 1 DR.458.011 Goldstein-Mini



Fig. 3 DR.458.031 Goldstein-Mini



Fig. 4 DR.458.041 Goldstein-Mini



Fig. 1 DR.459.011 Goldstein-Micro



Fig. 4/5 DR.460.051 Gregg



Fig. 0 DR.463.001 Heidemann



Fig. 1 DR.463.011 Heidemann



Fig. 2 DR.463.021 Heidemann



Fig. W3 DR.513.031



Fig. 1 DR.425.011



Fig. 6 DR.425.061



Fig. 178 DR.426.781



Fig. 49 DR.440.491



Fig. 179 DR.440.791

Restorative

Composite/Plastic Filling Instruments



Easy
COLOR



DD.100.321
Burnisher

Fig. 31/32
DR.100.321

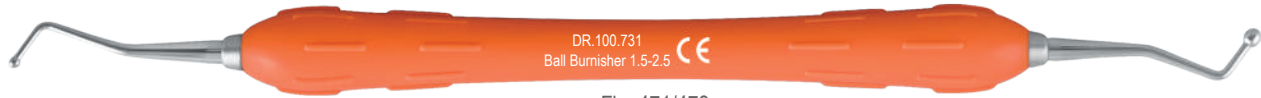

DR.100.731
Ball Burnisher 1.5-2.5

Fig. 471/473
DR.100.731



DR.121.111
Packer-Modeller 10

Fig. 482/483
DR.121.111

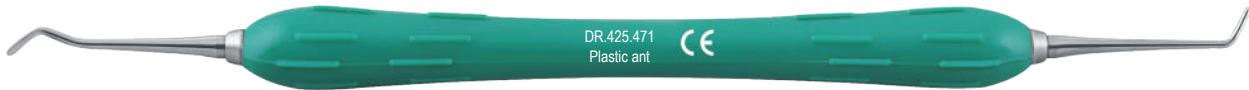

DR.425.471
Plastic ant

Fig. 43/47
DR.425.471

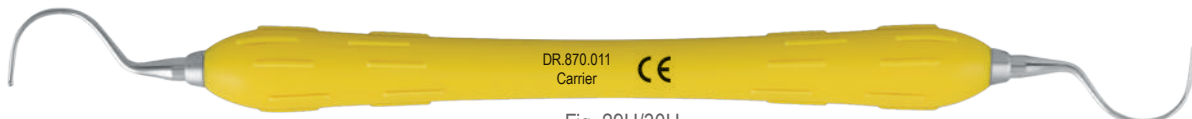

DR.870.011
Carrier

Fig. 29H/30H
DR.870.011

Carvers

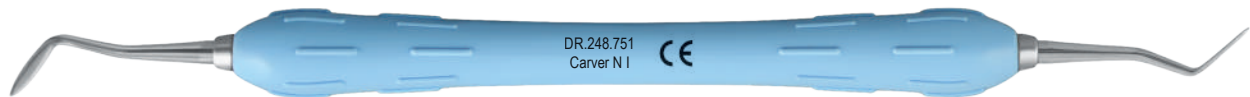

DR.248.751
Carver N I

Fig. N I
DR.248.751
Nyström I

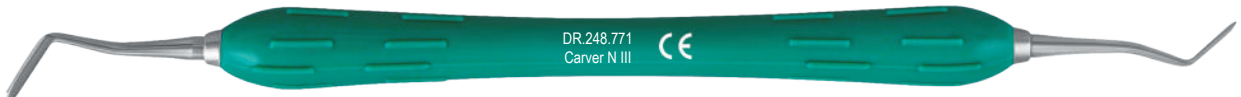

DR.248.771
Carver N III

Fig. N III
DR.248.771
Nyström III

Gingival Margin Trimmers



DR.370.011
GM Trim distal 1.2

Fig. 121/122
DR.370.011

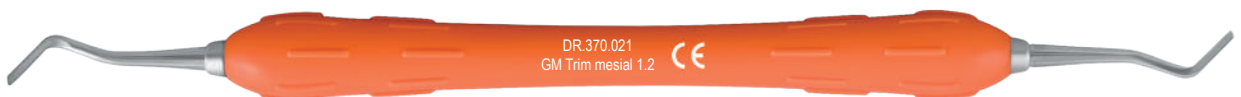

DR.370.021
GM Trim mesial 1.2

Fig. 125/126
DR.370.021

Excavators



Easy
COLOR



DR.608.011



DR.608.021



DR.608.111



DR.608.121



DR.608.131



DR.608.211



DR.608.221



DR.608.231



DR.608.241

Compo-fill
Instruments TIN Coated



Pluggers



Fig. 1/2 DR.063.025T Black



Fig. 1 DR.091.015T Super



Fig. 3 DR.073.035T Hollenback



Fig. 0T DR.092.005T Tanner

Burnishers



Fig. 21B DR.111.215T Acorn/ Wescott



Fig. 3 DR.139.035T Ladmore



Fig. 1 DR.121.015T Contact Former



Fig. 27/29 DR.148.045T White

Filling Instruments



Fig. 1 DR.425.015T



Fig. 1 DR.457.015T Goldstein



Fig. 6 DR.425.065T



Fig. 2 DR.457.025T Goldstein



Fig. 156 (A6) DR.426.565T



Fig. 4 DR.458.045T Goldstein-mini



Fig. 178 DR.426.785T



Fig. 4/5 DR.460.055T Gregg



Fig. 49 DR.440.495T



Fig. 2 DR.463.025T Heidemann

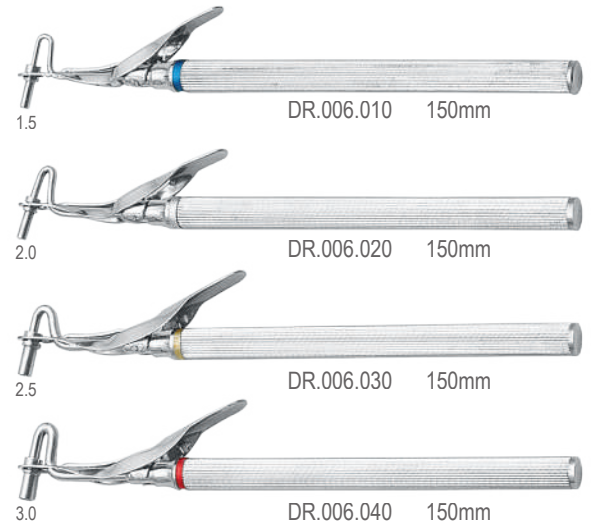
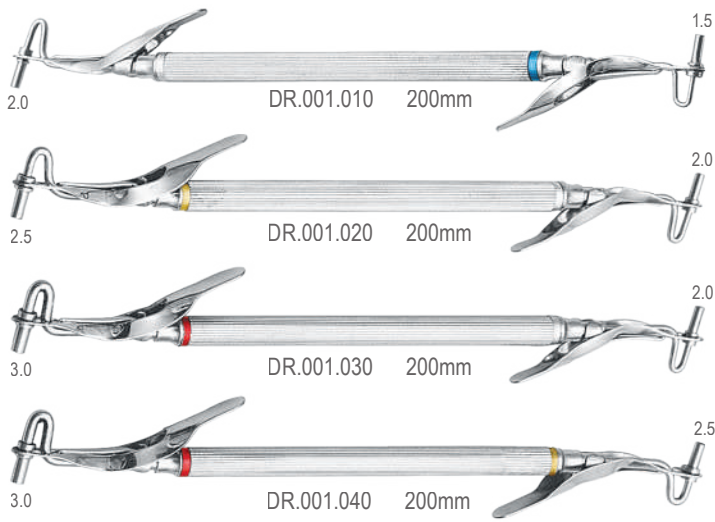

Fig. 2 DR.451.025T Falcon

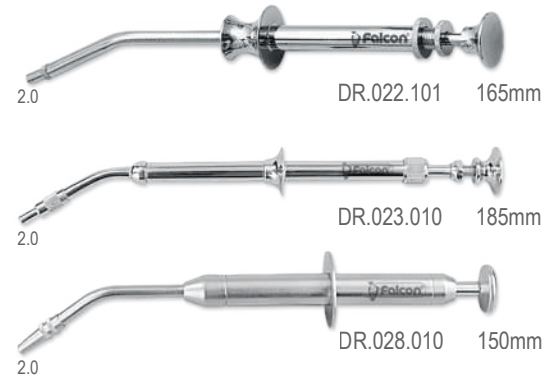
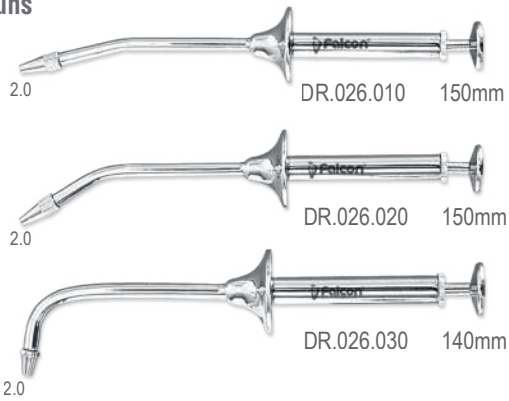

Fig. W3 DR.513.035T

Amalgam Carriers



Amalgam Guns



Amalgam Well



DR.098.010
Autoclavable

Amalgam Gun For Micro Filling



Ø 1.2 mm	Ø 1.8 mm	
DR.024.020	DR.024.040	Straight
DR.024.030	DR.024.050	Curved
130 mm	130 mm	

Pluggers



8 mm hollow handle

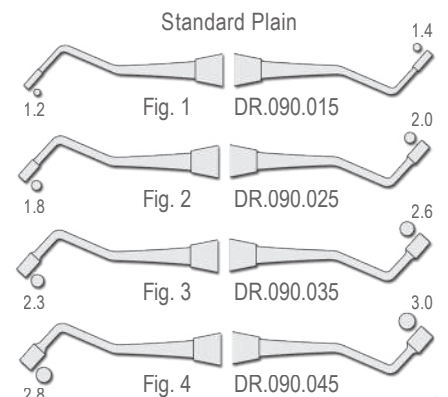
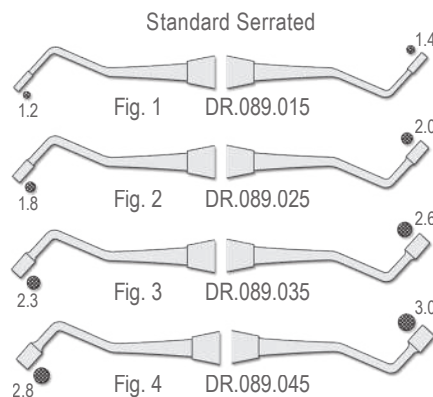
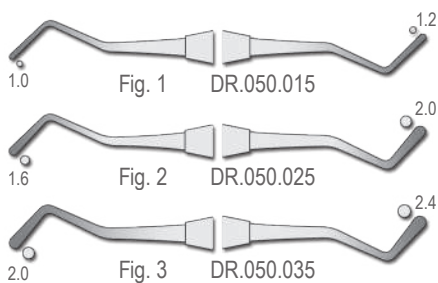

Pluggers



6 mm solid handle

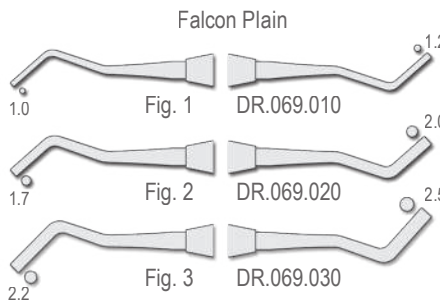
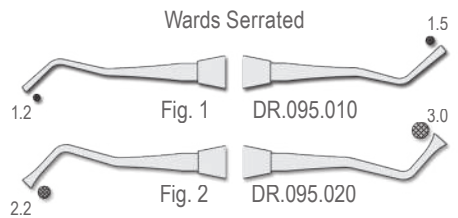
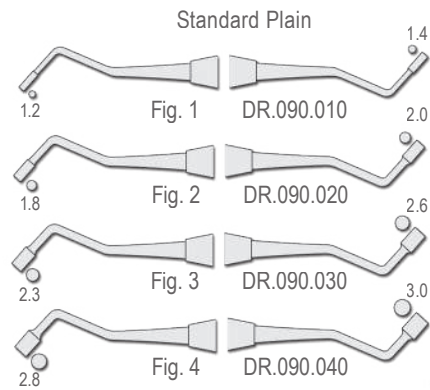
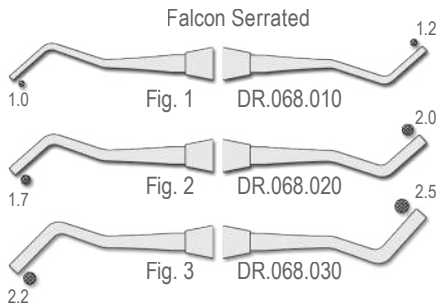
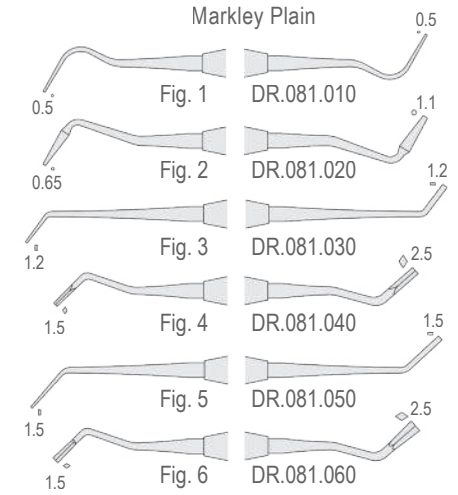
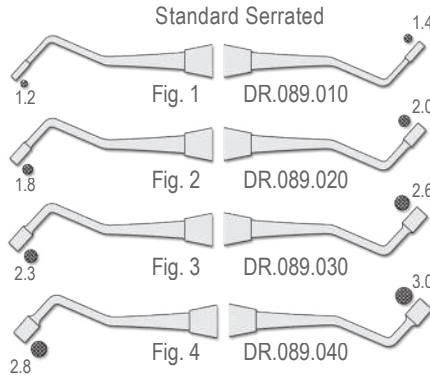
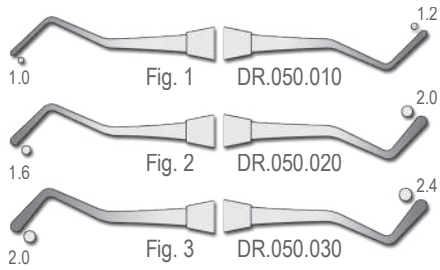

Pluggers



5.5 mm solid handle

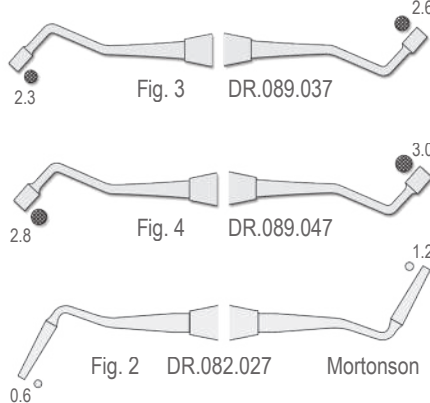
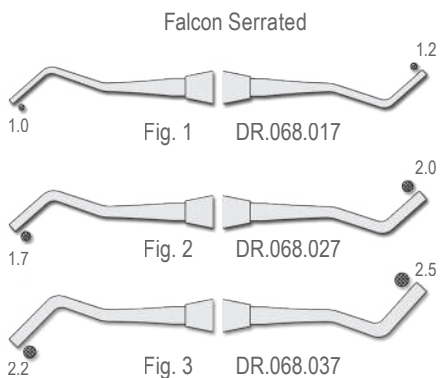
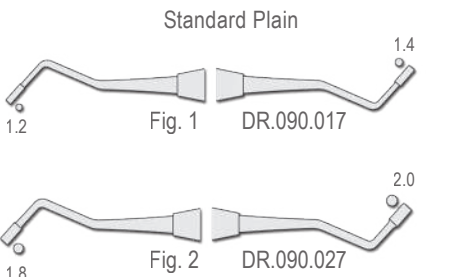
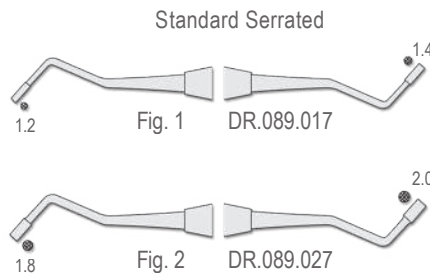
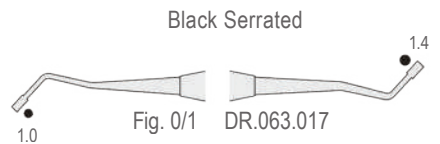

Burnishers

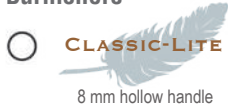

Acron / Wescott



Freedman

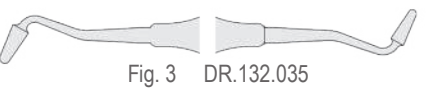

Falcon



White

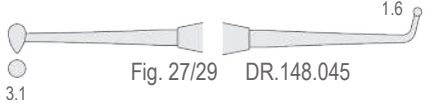

Falcon



Burnishers

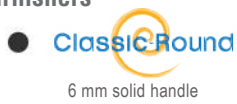

Acorn / Wescott

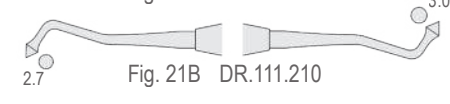
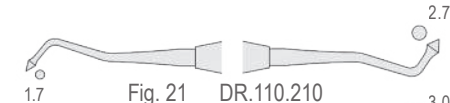

Beavertail / White

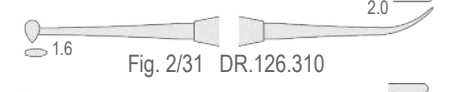
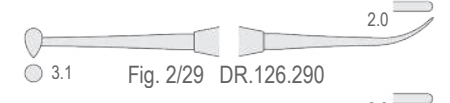

Ladmore

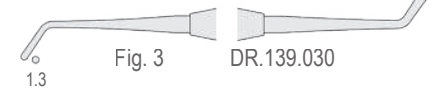

White

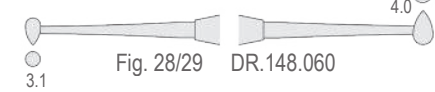
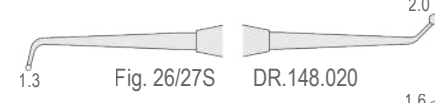

Falcon

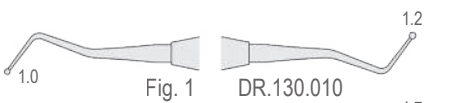

Burnishers

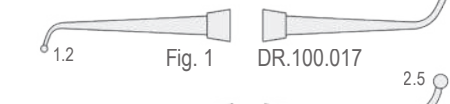
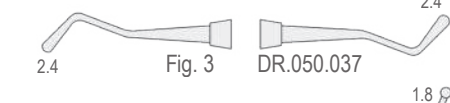
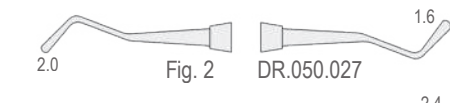
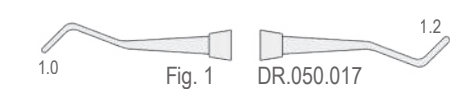

Falcon

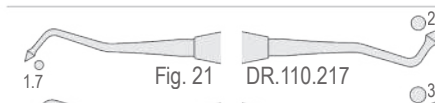
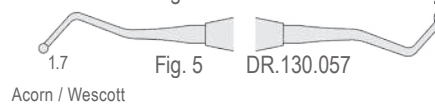
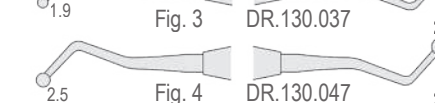
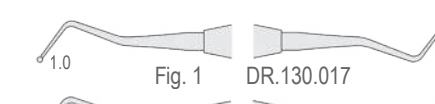

Beavertail / White

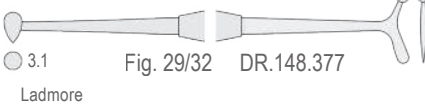
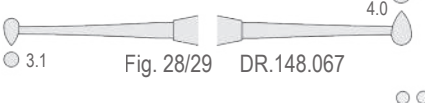
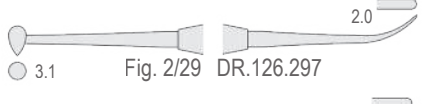

Ladmore

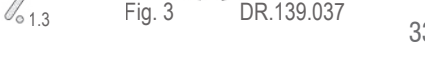
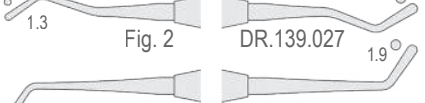

Restorative

Filling Instruments



8 mm hollow handle



Falcon

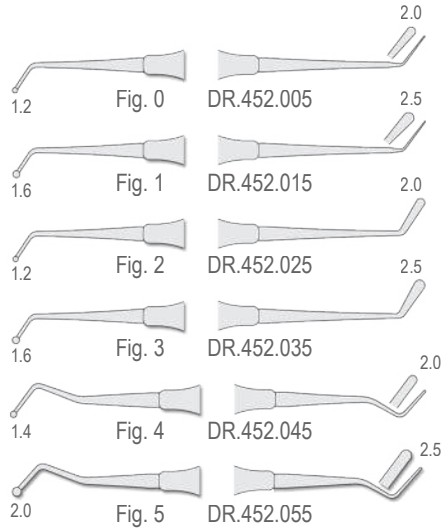

Falcon

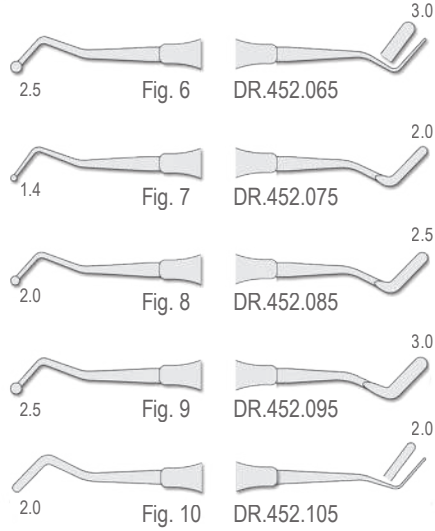

Falcon

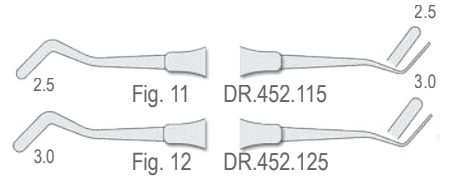

Heidemann

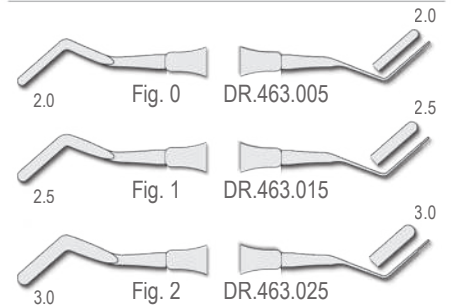

Filling Instruments



6 mm solid handle



Falcon

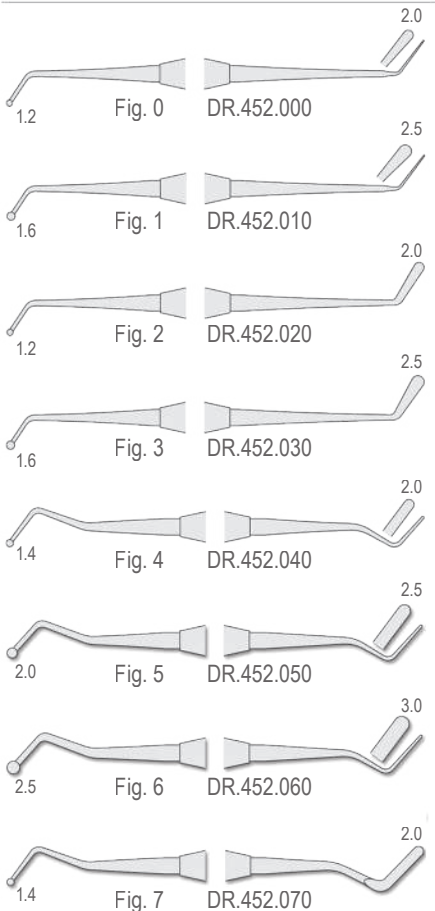

Falcon

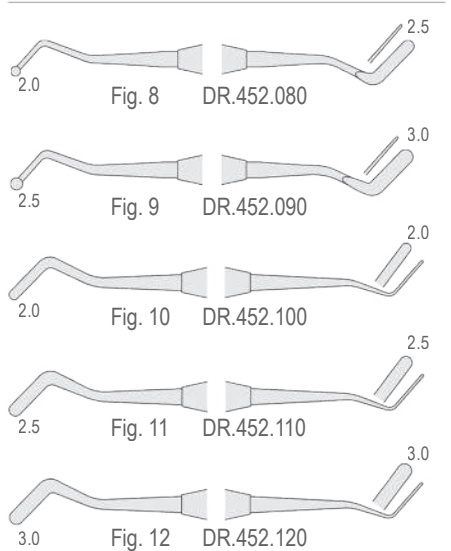

Heidemann

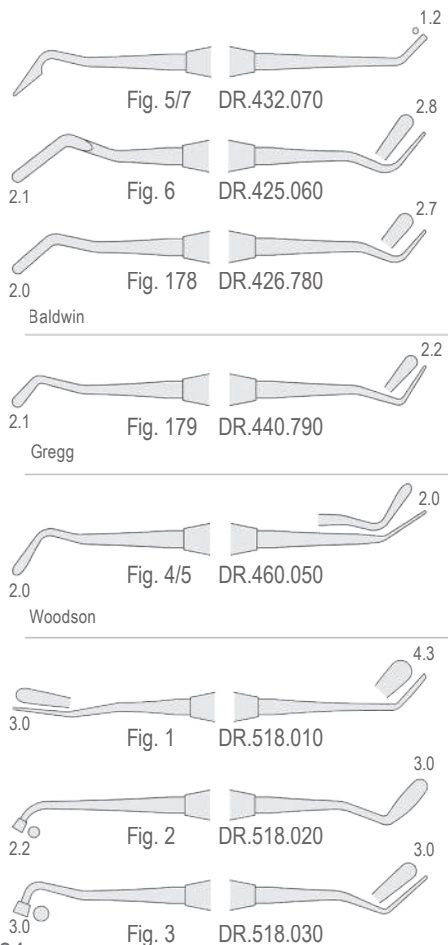
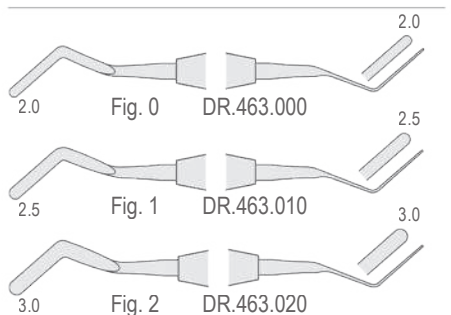

Filling Instruments

Classic-8
5.5 mm solid handle

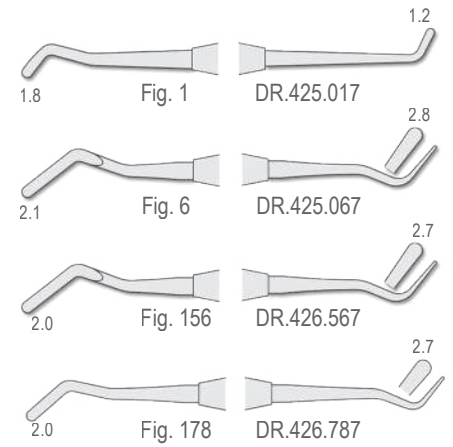
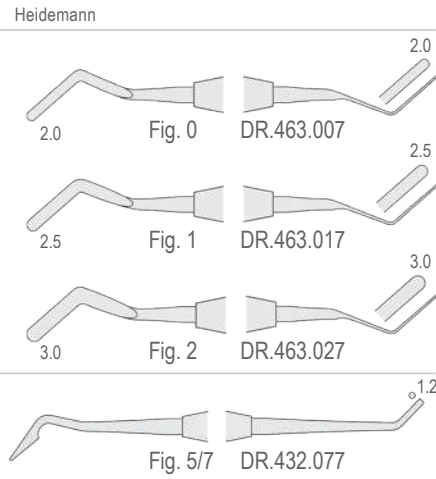
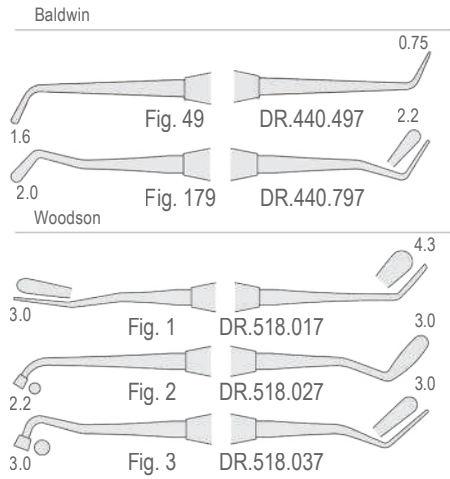

Cement Spatulae



Cement Spatulae

Classic Round
6 mm solid handle

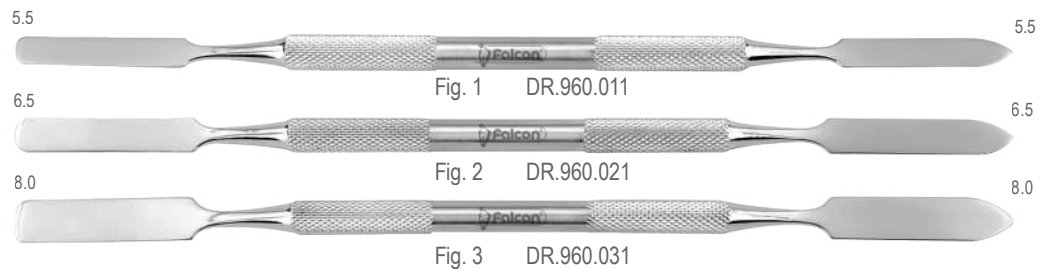

Cement Spatulae

Classic-8
5.5 mm solid handle



Glass Slabs



A	B	C	
mm	mm	mm	
95	70	5	DR.998.010
120	80	5	DR.998.020
150	80	12	DR.998.030

Applicators For Calcium Hydroxide



Applicator For Medicaments



Filling Instruments Set of 10 Pieces

DR.999.007
Contents: 1 each of following

- DR.089.017 Classic-8 plugger de Standard serrated fig. 1
- DR.089.027 Classic-8 plugger de Standard serrated fig. 2
- DR.130.027 Classic-8 Burnisher de Falcon fig. 2
- DR.130.037 Classic-8 Burnisher de Falcon fig. 3
- DR.463.017 Classic-8 Filling instrument de Heidemann fig. 1
- DR.960.027 Classic-8 cement spatula de Falcon fig. 2
- DR.623.027 Classic-8 Excavator de Falcon fig. 2
- DR.225.037 Classic-8 Carver de Frahm fig. 2/3
- DR.148.377 Classic-8 Burnisher de Beavertail/White fig. 29/32
- DR.872.002 Placement instrument se for calcium hydroxide



Carvers

● **Classic Round**
6 mm solid handle

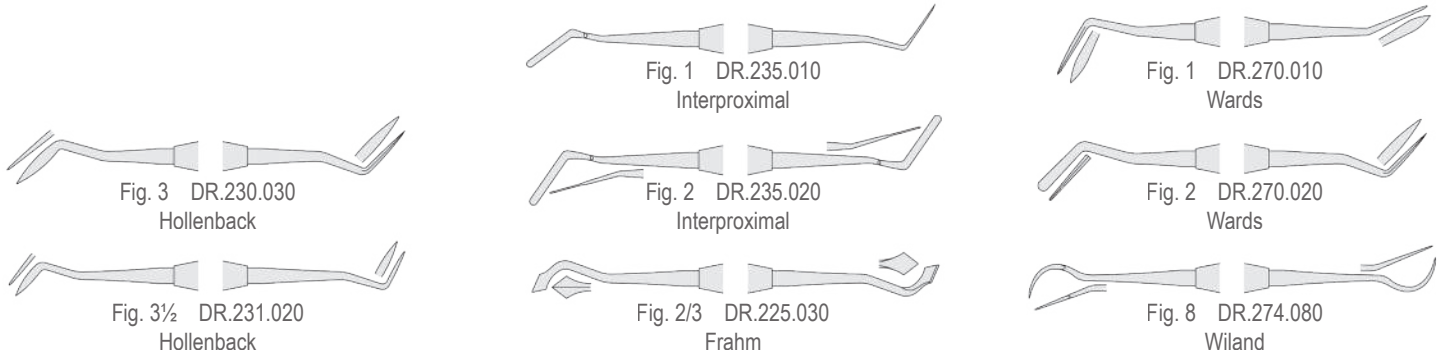

Carvers

● **Classic-8**
5.5 mm solid handle

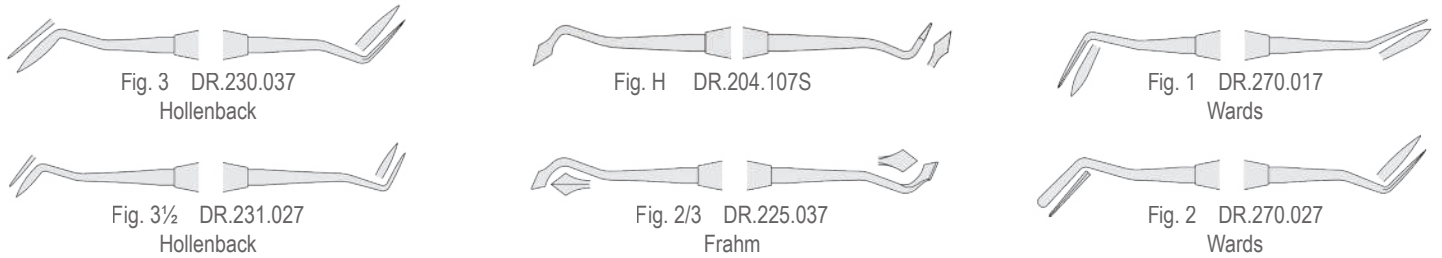

Cleoid-Discoid

● **Classic Round**
6 mm solid handle

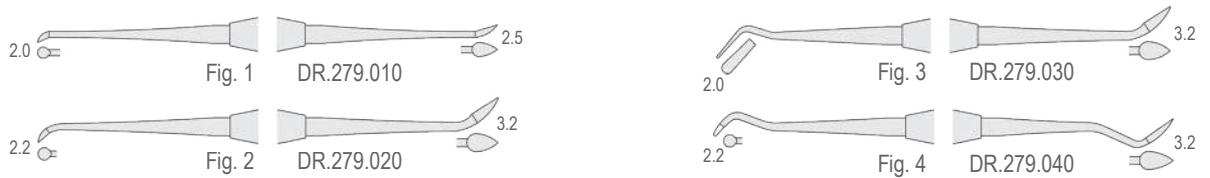

Finishing Knives

○ **CLASSIC-LITE**
8 mm hollow handle

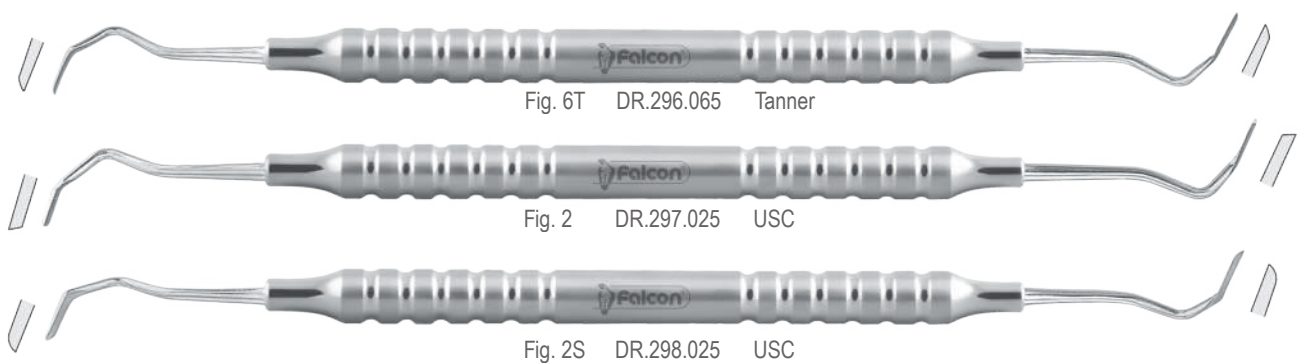

Restorative

Excavators

○ **Classic-Lite**
10 mm hollow handle

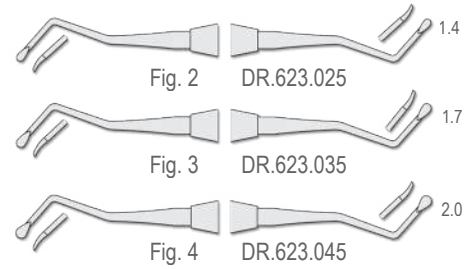
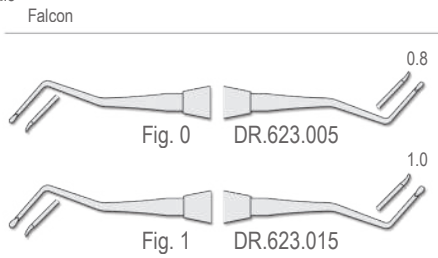

Excavators

● **Classic Round**
6 mm solid handle

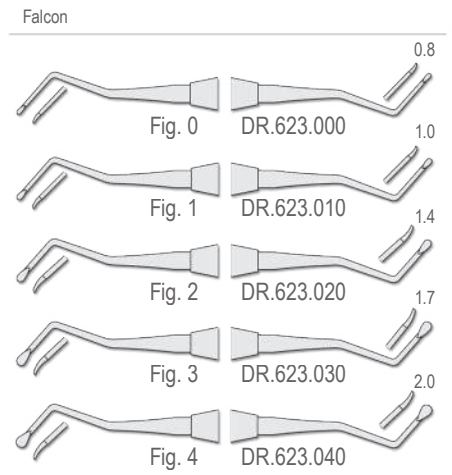
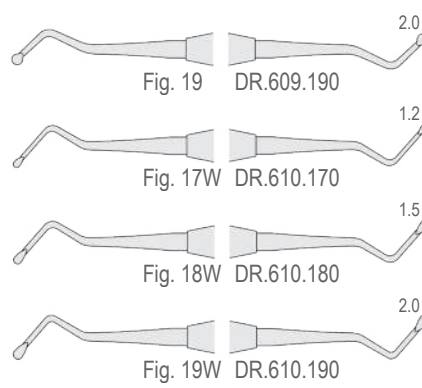
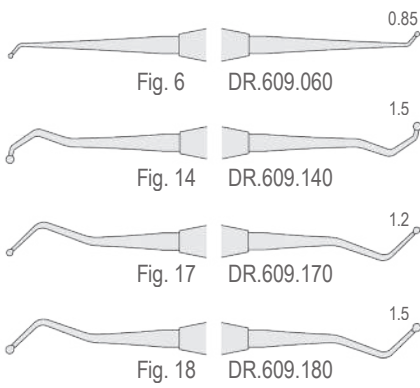

Excavators

● **Classic-8**
5.5 mm solid handle

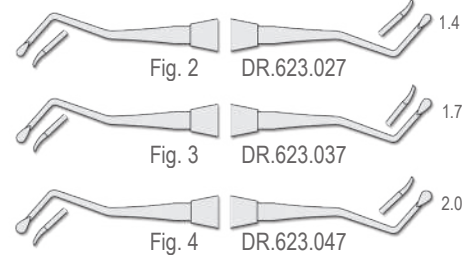
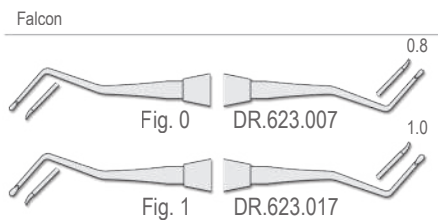

Cavity Preparation Instruments

● **Classic Round**
6 mm solid handle

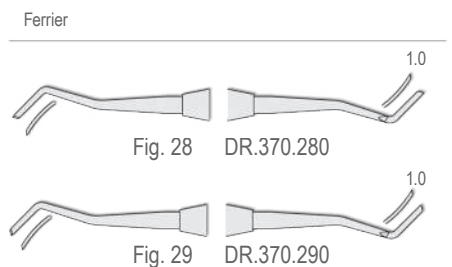
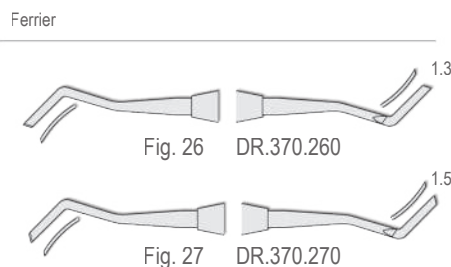
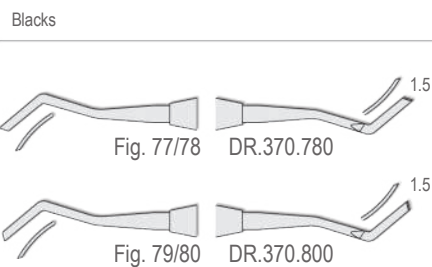

Automatic Crown And Bridge Remover



Fig. 1 DR.549.001



Fig. 2 DR.549.002



Fig. 3 DR.549.003



DR.549.004
Mounting kit
(Wrench and key)



Falcon
DR.549.010
Complete with 3 tips and mounting kit

DR.549.010
Set of 3 tips and mounting kit

Manual Crown Remover Double Ended



Fig. 1 DR.554.001



Fig. 2 DR.554.002



Fig. 3 DR.554.003



Falcon
DR.554.010
Complete with 3 tips

DR.554.010
Set of 3 tips

Manual Crown Remover



Fig. 1 DR.559.001



Fig. 2 DR.559.002



Fig. 3 DR.559.003



Morrel
DR.559.010
Complete with 3 tips

DR.559.010
Set of 3 tips

Manual Crown Remover Double Ended



Fig. 1 DR.555.001



Fig. 2 DR.555.002



DR.555.000
Falcon
Complete with 2 tips

DR.555.010
Set of 2 tips

Manual Crown Remover With Spring



Fig. 1 DR.559.001



Fig. 2 DR.559.002



Fig. 3 DR.559.003



Morrel
DR.560.010
Complete with 3 tips

DR.560.010
Set of 3 tips

Manual Crown Remover



Fig. 1 DR.555.001



Fig. 2 DR.555.002



DR.555.000
Falcon
Complete with 2 tips

DR.555.010
Set of 2 tips

Restorative

Crown Pliers



DR.531.160
Falcon
160 mm
With Tungsten Carbide inserts



DR.532.160
Wynman-Falcon
160 mm
With Tungsten Carbide inserts

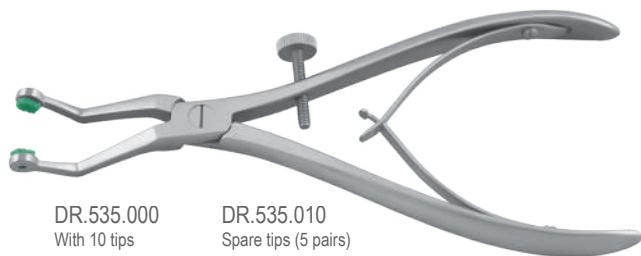

DR.535.000 With 10 tips
DR.535.010 Spare tips (5 pairs)



DR.539.010
Furrer
160 mm

Crown Spreaders

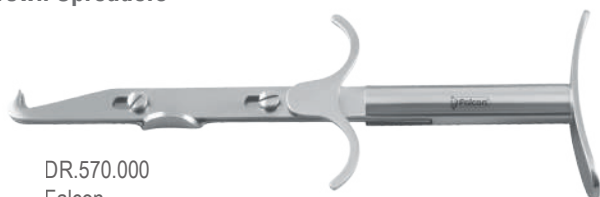

DR.570.000
Falcon



Fig. 0 DR.571.000



Fig. 1 DR.571.010



Fig. 2 DR.571.020



Fig. 3 DR.571.030

Forceps For Articulating Paper



DR.700.010
Miller
150 mm



DR.700.020
Miller
150 mm



DR.698.010
Falcon
150 mm



DR.699.010
Falcon
Full arch

Matrix Bands

Thickness 0.04 mm



DR.799.050 5 mm
DR.799.060 6 mm
DR.799.070 7 mm
Length 10 m

Thickness 0.05 mm



DR.800.050 5 mm
DR.800.060 6 mm
DR.800.070 7 mm
Length 10 m

Siqveland (pack of 12)



DR.809.010 Narrow



DR.809.020 Wide

Matrix Retainers



5 mm
DR.829.050
Falcon



DR.840.010
Tofflemire-Junior



Fig. 12A
DR.830.121
Ivory



5 mm 6 mm 7 mm
DR.830.085 DR.830.086 DR.830.087
Ivory Ivory Ivory



DR.840.020
Tofflemire-Senior



Fig. 12
DR.830.120
Ivory



DR.830.089
Fig. 8N
Ivory



DR.840.030
Tofflemire-Universal



Left Right
DR.832.010 DR.832.020
Nyström Nyström



DR.835.010 DR.835.020
Narrow Wide
Siqveland Siqveland



DR.855.010
Matrix clamp

Matrix Forceps



Falcon
DR.820.170
170 mm

Rubber Dam Clamps Kit



DR.904.020
1 each of
Fig. 00, 0, 1, 2, 2A, 7, 8, 8A, 9, 14, 14A, 212



DR.904.030
1 each of
Fig. A, AW, BW, C, DW, E, EW, FW, G, K, L, M



DR.909.100
1 each of
Fig. 00, 2, 2A, 3, 7, 8A, 9, 14, 14A, 212

Rubber Dam Clamps Anteriors



Fig. 9
DR.906.090



Fig. 210
DR.906.210



Fig. 211
DR.906.211



Fig. 212
DR.906.212



Fig. C
DR.905.004

Rubber Dam Clamps Premolars



Fig. 00
DR.906.100



Fig. 0
DR.906.110



Fig. 1
DR.906.120



Fig. 2
DR.906.130



Fig. 2A
DR.906.140



Fig. 27
DR.906.020



Fig. 206
DR.906.150



Fig. 209
DR.906.180



Fig. DW
DR.905.005



Fig. E
DR.905.006



Fig. EW
DR.905.007



Fig. GW
DR.905.010



Fig. L
DR.905.014



Fig. M
DR.905.015

Rubber Dam Clamps Molars



Fig. 3
DR.906.500



Fig. 4
DR.906.510



Fig. 7
DR.906.530



Fig. 8
DR.906.550



Fig. 8A
DR.906.560



Fig. 12A
DR.906.570



Fig. 13A
DR.906.580



Fig. 14
DR.906.590



Fig. 14A
DR.906.600



Fig. 26
DR.906.370



Fig. 201
DR.906.620



Fig. 205
DR.906.660



Fig. A
DR.905.001



Fig. AW
DR.905.002



Fig. BW
DR.905.003



Fig. FW
DR.905.008



Fig. G
DR.905.009



Fig. HW
DR.905.011



Fig. JW
DR.905.012



Fig. K
DR.905.013



Fig. NW
DR.905.016



Fig. PW
DR.905.017

Rubber Dam Clamps Tray



DR.904.010
Falcon

Rubber Dam Template

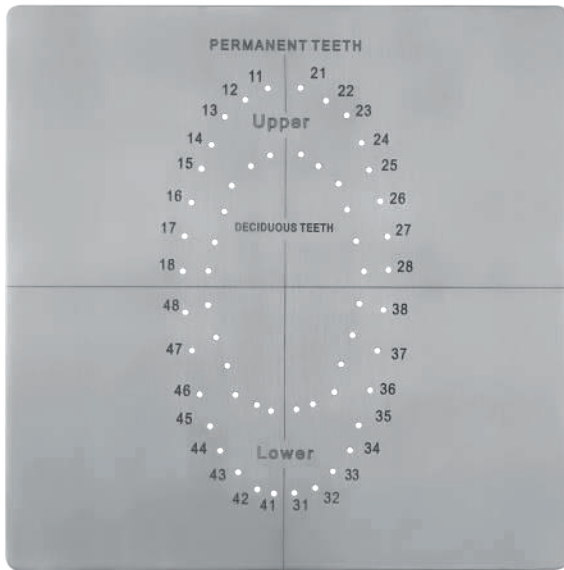

DR.948.000
150 x 150 mm
Autoclavable

Rubber Dam Frames



DR.938.110 110 mm
DR.938.130 130 mm
DR.938.150 150 mm
Young

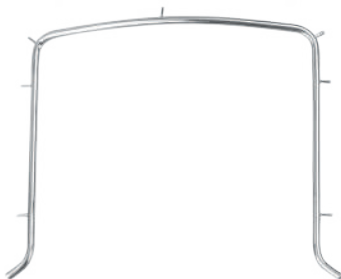

DR.937.000 150 mm
Falcon



DR.937.010
Falcon

Rubber Dam Clamp Forceps

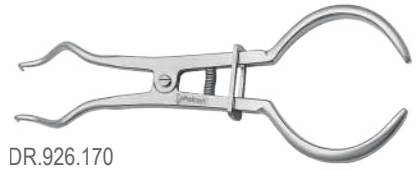

DR.926.170
Brewer



DR.928.170
IV



DR.929.170
Falcon



DR.931.170
Stokes



DR.932.170
Stokes/Palmer

Rubber Dam Punches



DR.940.160
Ainsworth



DR.946.160
IV

Rubber Dam Instruments Sets



DR.900.001
Rubber dam Instruments set UK Pattern
Contents 1 each:

DR.905.001	Clamp fig. A	DR.904.010	Clamps tray
DR.905.002	Clamp fig. AW	DR.926.170	Forceps Brewer
DR.905.003	Clamp fig. BW	DR.938.130	Frame Young 130 mm
DR.905.004	Clamp fig. C	DR.940.160	Punch Ainsworth
DR.905.005	Clamp fig. DW	DR.948.000	Template
DR.905.006	Clamp fig. E	DZ.086.030	Tray
DR.905.007	Clamp fig. EW	DZ.430.100	Rack
DR.905.008	Clamp fig. FW		
DR.905.009	Clamp fig. G		
DR.905.013	Clamp fig. K		
DR.905.014	Clamp fig. L		
DR.905.015	Clamp fig. M		

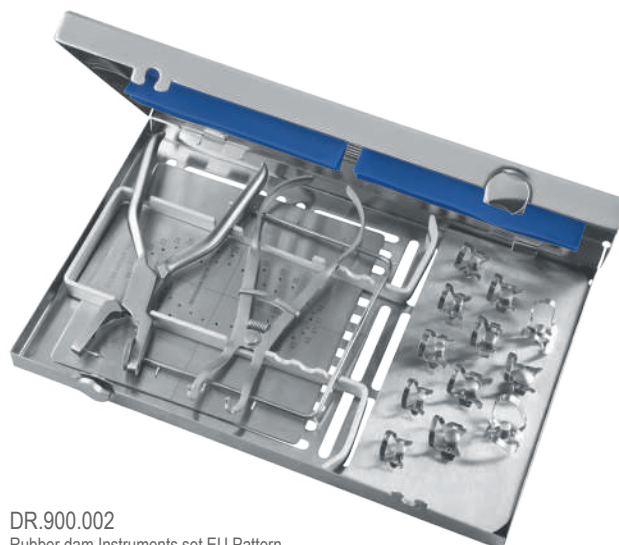

DR.900.002
Rubber dam Instruments set EU Pattern
Contents 1 each:

DR.906.100	Clamp fig. 00	DR.904.010	Clamps Tray
DR.906.110	Clamp fig. 0	DR.928.170	Forceps IV
DR.906.120	Clamp fig. 1	DR.938.130	Frame Young 130mm
DR.906.130	Clamp fig. 2	DR.940.160	Punch Ainsworth
DR.906.140	Clamp fig. 2A	DR.948.000	Template
DR.906.530	Clamp fig. 7	DZ.086.030	Tray
DR.906.550	Clamp fig. 8	DZ.430.100	Rack
DR.906.560	Clamp fig. 8A		
DR.906.090	Clamp fig. 9		
DR.906.590	Clamp fig. 14		
DR.906.600	Clamp fig. 14A		
DR.906.212	Clamp fig. 212		

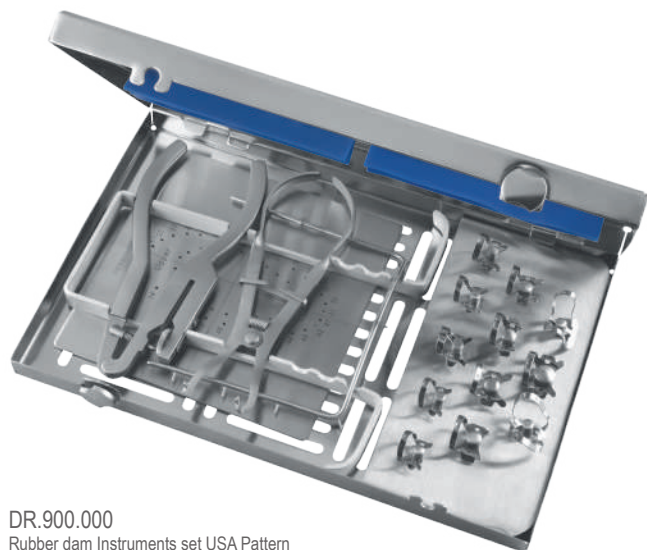

DR.900.000
Rubber dam Instruments set USA Pattern
Contents 1 each:

DR.906.100	Clamp fig. 00	DR.904.010	Clamps Tray
DR.906.110	Clamp fig. 0	DR.928.170	Forceps IV
DR.906.120	Clamp fig. 1	DR.938.130	Frame Young
DR.906.130	Clamp fig. 2	DR.946.160	Punch IV
DR.906.140	Clamp fig. 2A	DR.948.000	Template
DR.906.530	Clamp fig. 7	DZ.086.030	Tray
DR.906.550	Clamp fig. 8	DZ.430.090	Rack
DR.906.560	Clamp fig. 8A		
DR.906.090	Clamp fig. 9		
DR.906.590	Clamp fig. 14		
DR.906.600	Clamp fig. 14A		
DR.906.212	Clamp fig. 212		



DR.909.900
Rubber dam Instruments set for student in carrying case
Contents 1 each:

DR.906.100	Clamp fig. 00	DR.926.170	Forceps Brewer
DR.906.130	Clamp fig. 2	DR.938.130	Frame Young
DR.906.140	Clamp fig. 2A	DR.940.160	Punch Ainsworth
DR.906.500	Clamp fig. 3		
DR.906.530	Clamp fig. 7		
DR.906.560	Clamp fig. 8A		
DR.906.090	Clamp fig. 9		
DR.906.590	Clamp fig. 14		
DR.906.600	Clamp fig. 14A		
DR.906.212	Clamp fig. 212		

SS•2000
Stainless Steel Series

Stainless steel series
Made of 18-8 stainless steel
Longer life than Brass syringes
No chipping of chrome
Guaranteed quality
Sterilizable by any method

Intraligamental Syringes



DA.010.180
Falcon-Ject Ultima
1,8 ml.

Injects 0.05 ml with every click
Supplied with angled and straight tubes



DA.020.180
Falcon-Ject angled
1,8ml.



DA.021.180
Falcon-Ject straight
1.8 ml.



DA.094.180
P-Ject
1.8 ml.

Manual Aspirating Syringes

DA.517.180
Type A
1.8 ml.



DA.557.180
Type C
1.8 ml.



DA.595.180
Euro
1.8 ml.



DA.635.180
T-Handle
1.8 ml.



DA.705.180
3- Ring
1.8 ml.

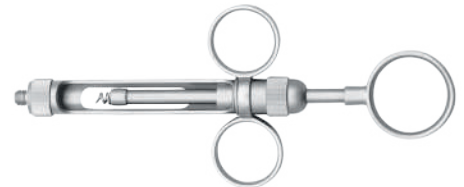

DA.801.180
Euro
Breech loading
1.8 ml.

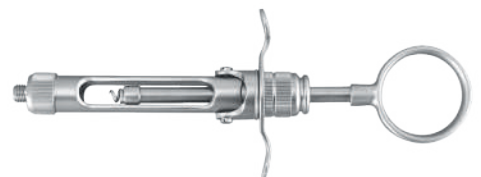

DA.806.180
Euro
Breech loading
1.8 ml.

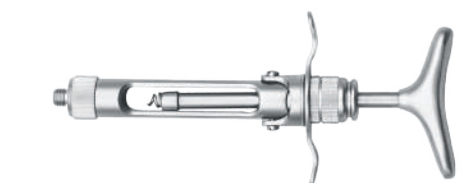

Brass Series

Made of Brass
 Chrome plated
 All Brass series syringes have stainless steel plungers
 Guaranteed quality
 Sterilizable by any method

Intraligamental Syringes

Injects 0.06 ml with every click



DA.095.180
 P-Ject
 1,8ml.

Injects 0.20 ml with every click
 Lever action for high injection pressure



DA.060.180
 Pistol-Ject
 1,8ml.



DA.035.000
 Plastic protection tube
 Autoclavable

Trio Manual Aspirating Syringes

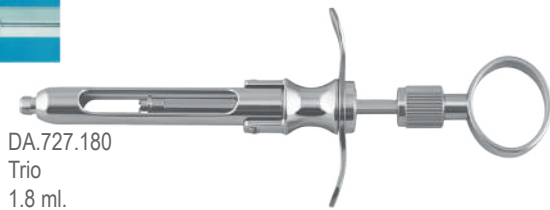

DA.727.180
 Trio
 1.8 ml.

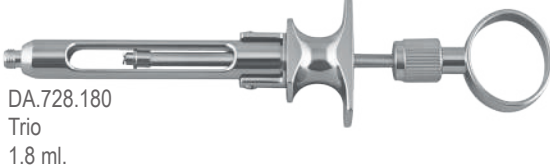

DA.728.180
 Trio
 1.8 ml.

P-Ject Manual Aspirating Syringes

Special aspiration tip



DA.561.180
 1,8 ml

Non Aspirating Syringes

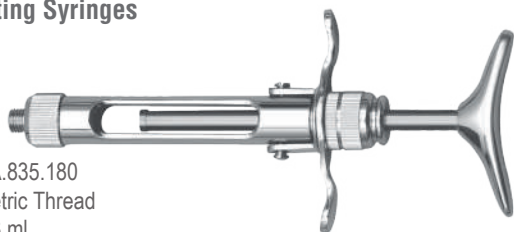

DA.835.180
 Metric Thread
 1.8 ml.
 Euro
 Breech loading, T - handle

Manual Aspirating Syringes



DA.520.180
 European
 1.8 ml.
 Type-A



DA.560.180
 European
 1.8 ml.
 Type-C



DA.620.180
 Metric Thread
 1.8 ml.
 Euro



DA.721.180
 Metric Thread
 1.8 ml.
 3 - Ring



DA.735.180
 Metric Thread
 1.8 ml.
 2 - Ring

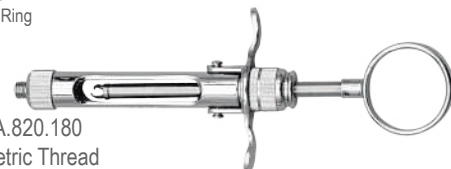

DA.820.180
 Metric Thread
 1.8 ml.
 Euro
 Breech loading, ring handle



DA.821.180
 Metric Thread
 1.8 ml.
 Euro
 Breech loading, T - handle



DA.819.180
 1.8 ml
 Euro
 Breech loading



DA.562.180
 Type-C
 1.8 ml

Self Aspirating Syringes

Self Aspiration: How it works

During use, the thumb pressure on the plunger or thumb disc stretches the diaphragm over a small metal projection inside of the syringe nozzle, increasing pressure inside of the cartridge. As the thumb pressure is released, pressure inside the cartridge lessens and aspiration occurs automatically. (Instruction for use are supplied with the product)

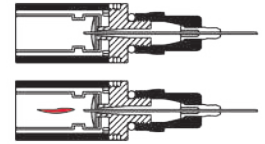

Self Aspirating Syringes

Dual self aspiration system:

Disc system syringe has dual aspiration feature to achieve self aspiration.

Aspiration before injection:

Insert syringe in tissue and press Thumb disc to achieve aspiration.

Aspiration during injection:

Automatic aspiration occurs whenever pressure on the plunger is released.

SS•2000
Stainless Steel Series



DA.115.180
Disc system
1.8 ml.

feather-lite



DA.120.180
Disc system
1,8ml.

Brass
SERIES



DA.145.180
Disc system
1,8ml.

Projection System Syringes

Aspiration during injection:

Automatic aspiration occurs whenever pressure on the plunger is released.

SS•2000
Stainless Steel Series



DA.315.180
Projection system
1.8 ml.

feather-lite



DA.320.180
Projection system
1,8ml.

Ultima
Needle Re-cappers

SS•2000
Stainless Steel Series

Falcon Needle Re-Cappers are the ideal way to prevent needle stick injuries when recapping needles. Place the upturned needle cap into Falcon Re-Capper and re-sheathing becomes a simple one hand procedure.

Needle Re-capper

SS•2000
Stainless Steel Series



DA.980.000

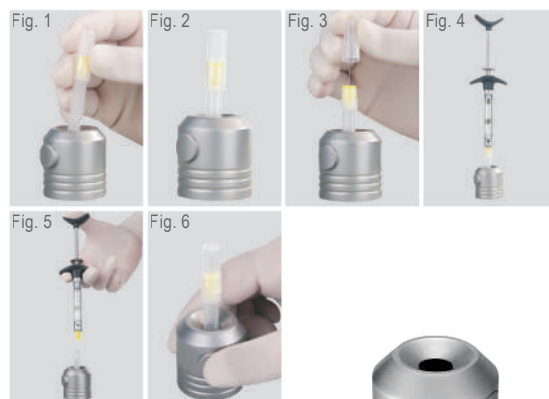

DA.990.000



Atraumatic Extraction

Periotomes

Periotomes are dental instruments used to cut periodontal ligaments for atraumatic tooth extractions and dental implant placement. They have thin sharp blades to facilitate the removal of teeth with minimal damage to surrounding alveolar bone.



Fig. 1 DP.690.015



Fig. 2 DP.690.025

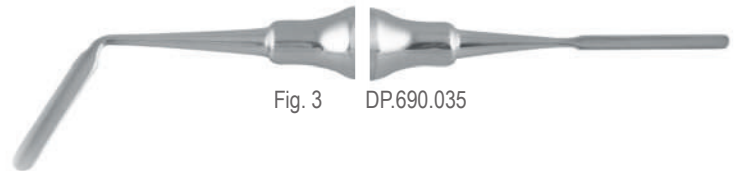
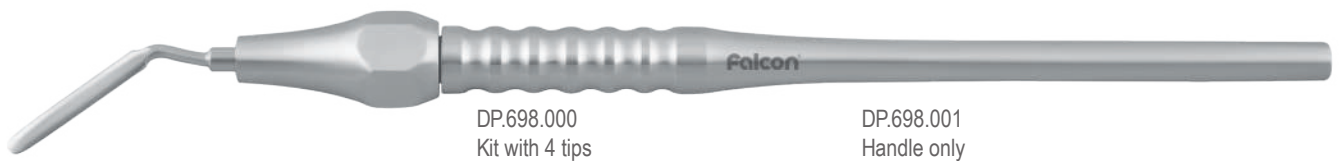

Fig. 3 DP.690.035

Ergo - Form Periotome Kit



DP.698.000
Kit with 4 tips

DP.698.001
Handle only



DP.698.010 Fig. 1



DP.698.020 Fig. 2



DP.698.030 Fig. 3



DP.698.040 Fig. 4

NiTi Flexible Periotomes

NiTi flexible periotomes cut the periodontal ligament (PDL) to aid in tooth extraction. NiTi is a flexible and unbreakable material.



DP.694.010



DP.694.020



DP.694.030



DP.694.040



DP.694.050



DP.694.060



DP.694.070



DP.694.080

Luxating Hybrids

A combination of a perioste and a luxating root elevator, to cut the periodontal ligaments in preparation for tooth extraction and minimize tooth extraction.



2.5 mm
● DE.917.010
Straight, micro serrated



2.5 mm
● DE.917.020
Curved, micro serrated



2.5 mm
● DE.917.030
Bayonet distal, micro serrated



2.5 mm
● DE.917.040
Mesial, micro serrated



4.0 mm
● DE.917.050
Bayonet distal, micro serrated



4.0 mm
● DE.917.060
Bayonet mesial, micro serrated



3.5 mm
● Bernhard
DE.917.070
Straight, micro serrated

Luxating Hybrids



3.5 mm
● Bernhard
DE.917.110
Straight



3.5 mm
● Bernhard
DE.917.120
Left



3.5 mm
● Bernhard
DE.917.130
Right



3.5 mm
● Bernhard
DE.917.140
Bayonet distal



3.5 mm
● Bernhard
DE.917.150
Bayonet mesial



4.5 mm
● DE.917.160
Mesial



4.5 mm
● DE.917.170
Distal

Luxating Hybrids- TiN Coated



2.5 mm
● DE.917.210
Straight



3.5 mm
● DE.917.220
Curved



2.5 mm
● DE.917.230
Bayonet distal



2.5 mm
● DE.917.240
Bayonet mesia1



3.5 mm
● DE.917.250
Bayonet distal



3.5 mm
● DE.917.260
Bayonet mesia1



3.5 mm
● Bernhard
DE.917.270
Straight

DE.917.200
Set of 7 pieces

Luxating Elevators

Ergo-form Elevators



Fig. 1
DE.920.015

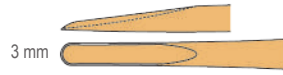

Fig. 2
DE.920.025

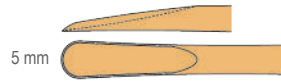

Fig. 3
DE.920.035

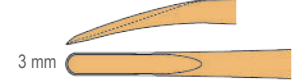

Fig. 4
DE.920.045

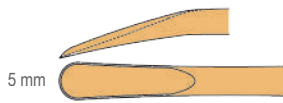

Fig. 5
DE.920.055

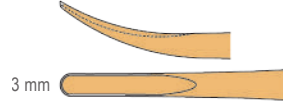

Fig. 6
DE.920.065

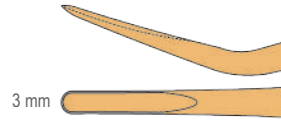

Fig. 7
DE.920.075

Luxating Elevators

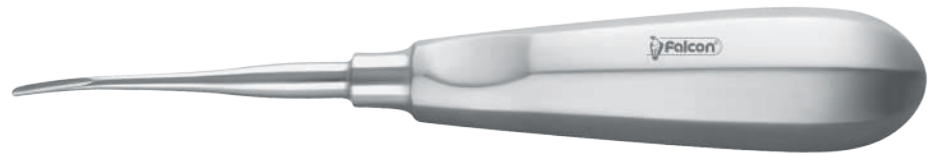

Fig. 1
DE.920.010



Fig. 2
DE.920.020



Fig. 3
DE.920.030



Fig. 4
DE.920.040

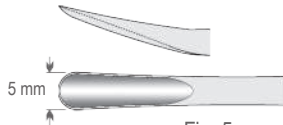

Fig. 5
DE.920.050



Fig. 6
DE.920.060



Fig. 7
DE.920.070



DE.920.000
Set of 7

Luxating Elevators



DE.920.120



DE.920.130



DE.920.140



DE.920.150



DE.920.220



DE.920.230



DE.920.240



DE.920.250

Atraumatic Extraction Forceps

Deep and Secure Grip

Fine and sharp beaks cut trough periodontium to achieve contact with root structure.

Reduce Fracture of Crown and Roots

Anatomically shaped to perfectly match the teeth and allow to reach deep and large contact areas to provide secure grip, thus avoiding fracture of the brittle crown.

Reduce Trauma of Soft Tissues

The fine beaks fit in areas where standard design cannot be applied and reduce trauma to the soft tissues as they are reflected rather than crushed.



Fig. 34
DE.910.340
Upper Incisors

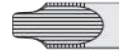
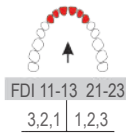

Fig. 34A
DE.910.341
Upper Incisors

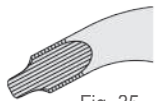
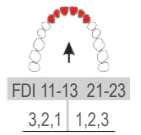

Fig. 35
DE.910.350
Upper Bicuspid

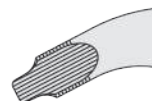
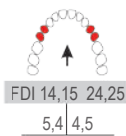

Fig. 35A
DE.910.351
Upper Bicuspid

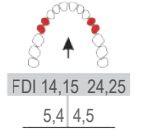

Fig. 36
DE.910.360
Lower Incisors and Canines

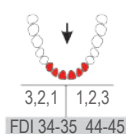
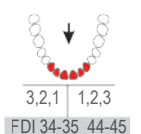

Fig. 36A
DE.910.361
Lower Incisors and Canines



Atraumatic Extraction

Atraumatic Extraction Forceps

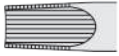

Fig. 34M
DE.910.343
Upper Incisors

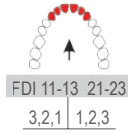

Fig. 34N
DE.910.344
Upper Incisors and Canines

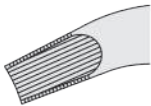
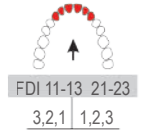

Fig. 35M
DE.910.353
Upper Bicuspid

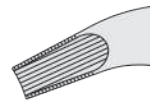
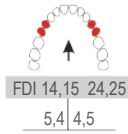

Fig. 35N
DE.910.354
Upper Bicuspid

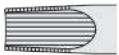
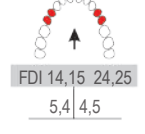

Fig. 36M
DE.910.363
Lower Incisors, Canines and Bicuspid

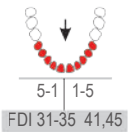

Fig. 36N
DE.910.364
Lower Incisors, Canines and Bicuspid

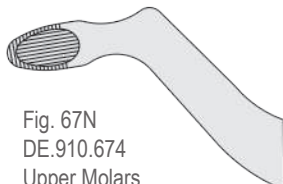

Fig. 67N
DE.910.674
Upper Molars

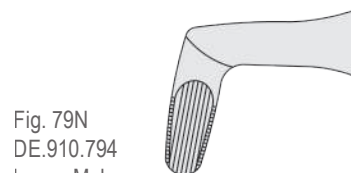
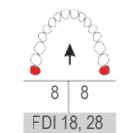
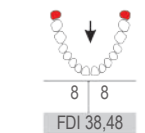

Fig. 79N
DE.910.794
Lower Molars



Luxating Elevators

Ergo-form Elevators



Autoclavable

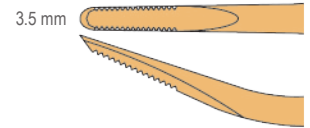

Fig. 3
DE.096.035
Falcon



Fig. 1
DE.095.015
Falcon

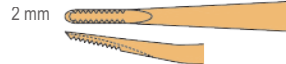

Fig. 2
DE.095.025
Falcon

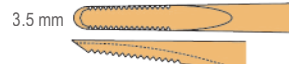

Fig. 1
DE.096.015
Falcon



Fig. 4
DE.096.045
Falcon



Fig. 6
DE.096.065
Falcon



Fig. 7
DE.096.075
Falcon



Fig. 1
DE.025.015
Bein



Fig. 6
DE.025.065
Bein



Fig. 7
DE.025.075
Bein



Fig. 2
DE.086.025
Flohr



Fig. 3
DE.086.035
Flohr



Fig. 30
DE.060.305
Cryer

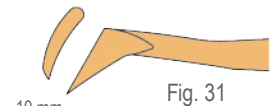

Fig. 31
DE.060.315
Cryer

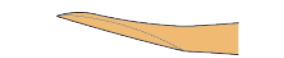

Fig. 1
DE.050.015
Coupland



Fig. 2
DE.050.025
Coupland

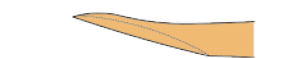

Fig. 3
DE.050.035
Coupland



Fig. 1
DE.290.015
Heidebrink



Fig. 2
DE.290.025
Heidebrink



Fig. 3
DE.290.035
Heidebrink



Fig. 11
DE.285.115
Bernhard

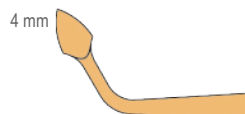

Fig. 6
DE.285.065
Bernhard



Fig. 7
DE.285.075
Bernhard



DE.190.085
Warwick-James



DE.190.055
Warwick-James



DE.190.075
Warwick-James

Elevators Bein

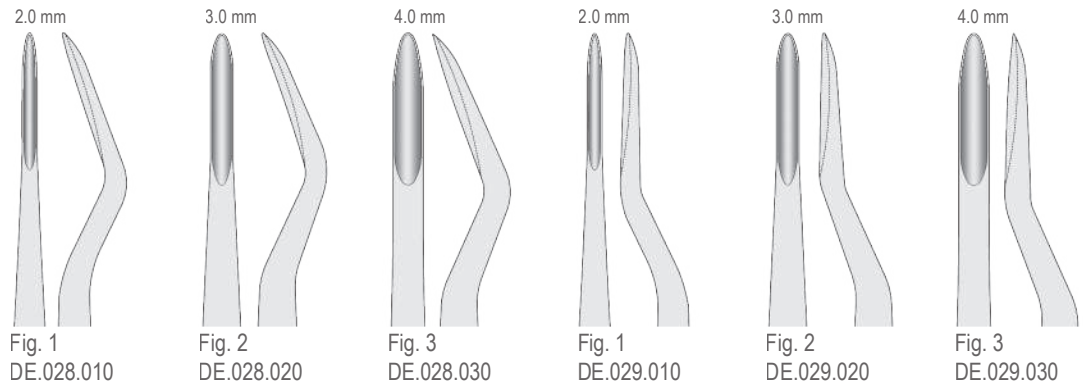
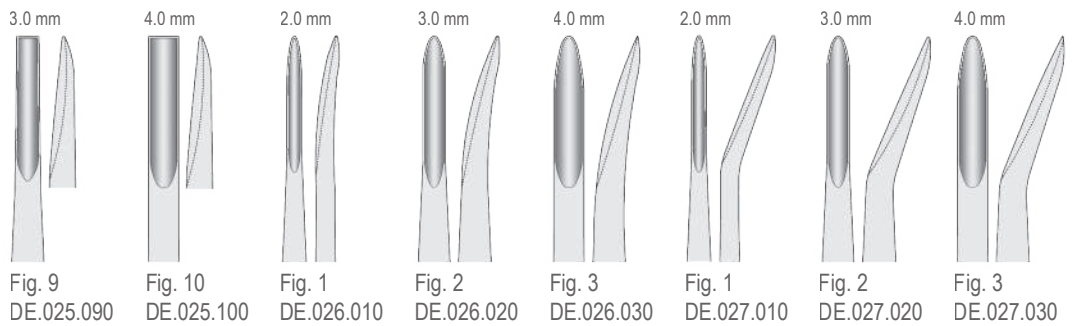
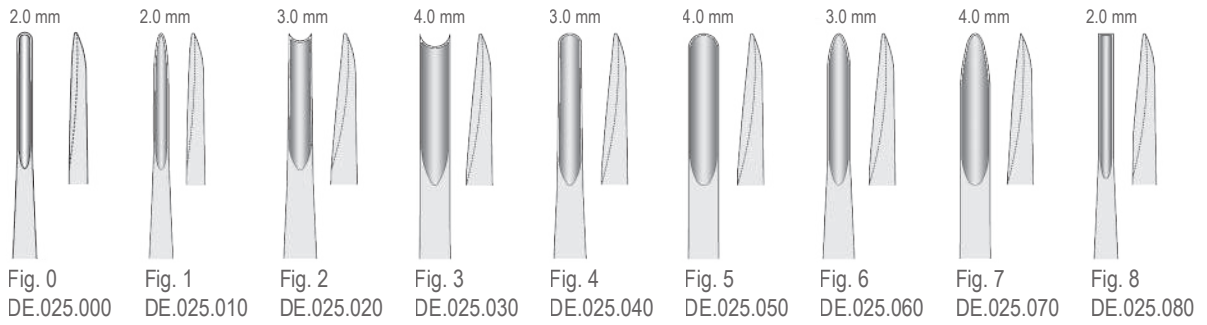

Elevators Bein

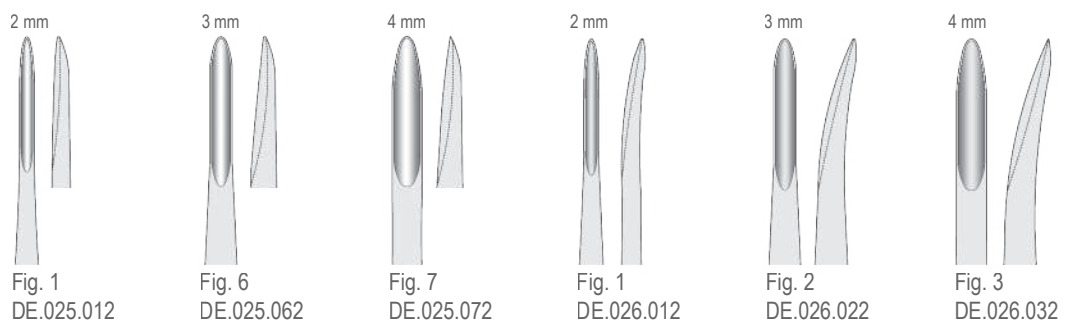
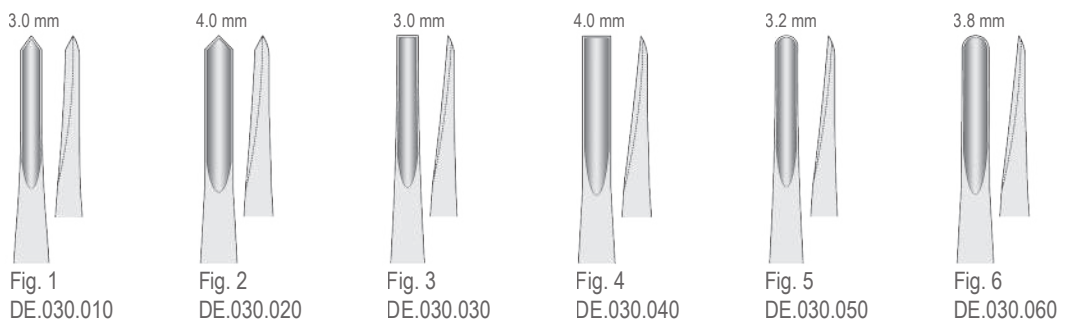

Root Elevators



2 mm DE.030.120 Bein	3 mm DE.030.130 Bein	4 mm DE.030.140 Bein	5 mm DE.030.150 Bein	2 mm DE.030.220 Bein	3 mm DE.030.230 Bein	4 mm DE.030.240 Bein	5 mm DE.030.250 Bein
3.0 mm Fig. 301 DE.015.301 Apical	3.5 mm Fig. 302 DE.015.302 Apical	3.5 mm Fig. 303 DE.015.303 Apical	3.5 mm Fig. 304 DE.015.304 Apical	3.0 mm Fig. 1 DE.050.011 Coupland	3.5 mm Fig. 2 DE.050.021 Coupland	4.0 mm Fig. 3 DE.050.031 Coupland	
12.5 mm Fig. 25 DE.070.250 Cryer	12.5 mm Fig. 26 DE.070.260 Cryer	14 mm Fig. 31 DE.070.310 Cryer	14 mm Fig. 32 DE.070.320 Cryer	10 mm Fig. 44 DE.070.440 Cryer	10 mm Fig. 45 DE.070.450 Cryer	3.5 mm Fig. 1 DE.086.012 Flohr	3.5 mm Fig. 2 DE.086.022 Flohr
5.0 mm Fig. 34 DE.155.340 Seldin	4.0 mm Fig. 34S DE.155.347 Seldin	13.0 mm Fig. 1L DE.155.015 Seldin	13.0 mm Fig. 1R DE.155.017 Seldin	10.0 mm Fig. 4L DE.155.045 Seldin	10.0 mm Fig. 4R DE.155.047 Seldin	3.5 mm Fig. 4 DE.153.040 Schmeckebier	3.5 mm Fig. 5 DE.153.050 Schmeckebier



DE.999.008
Contents
1 each of
DE.030.130
DE.030.140
DE.030.150
DE.070.250
DE.070.260
DE.086.022
DE.086.032

Extraction

Root Elevators

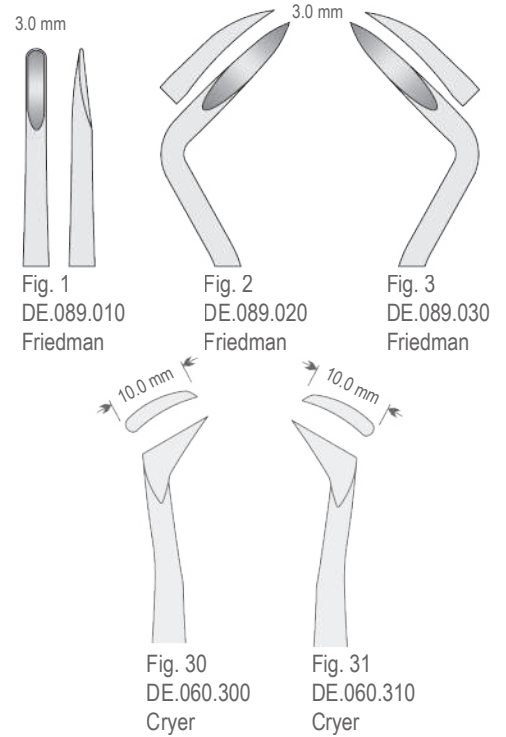
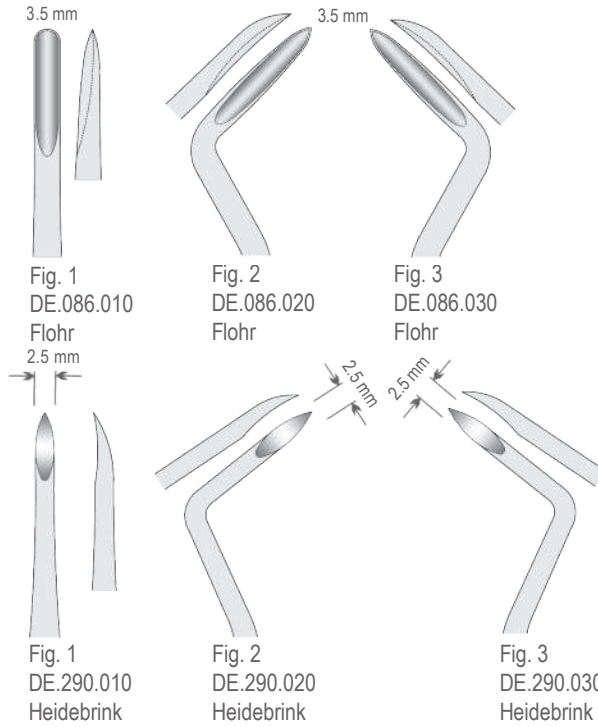

Elevators Lindo-Levian Serrated

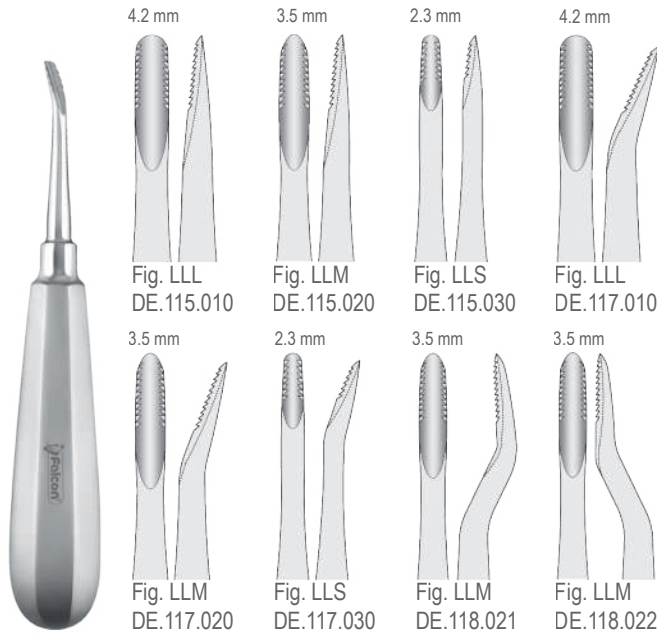

Elevators Warwick-James

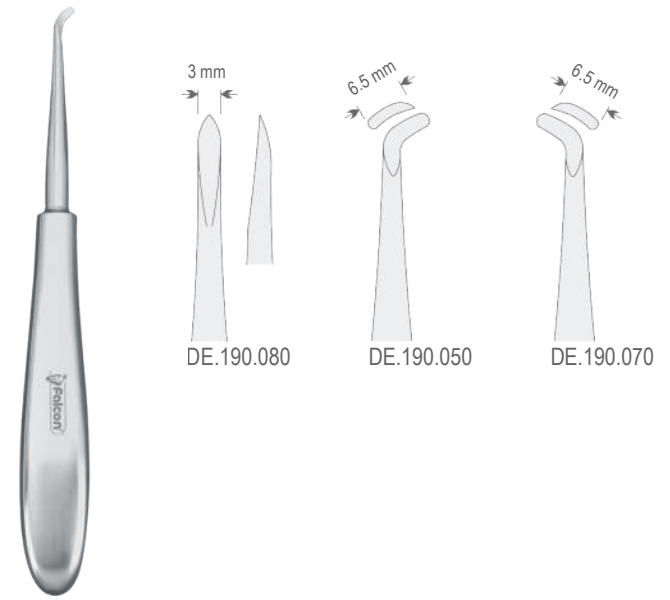

Elevators

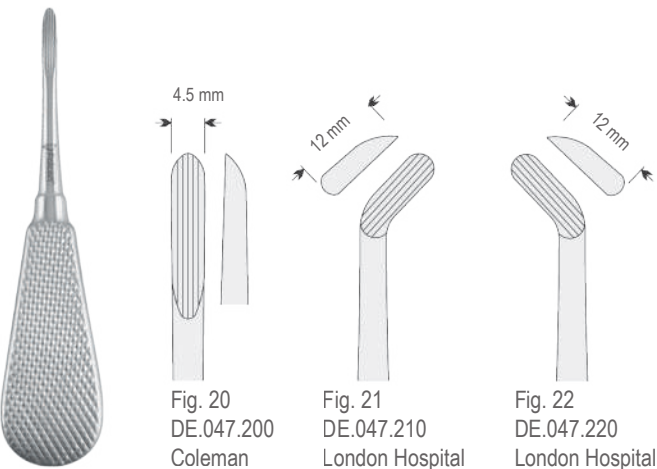

Elevators Hylin

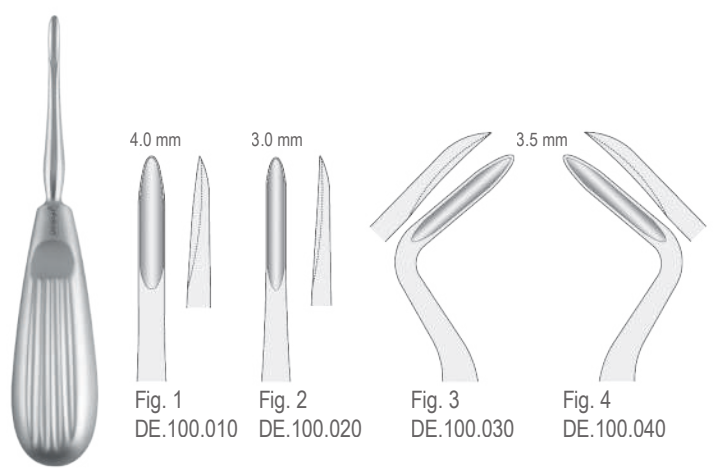

Elevators Anatomical Handle

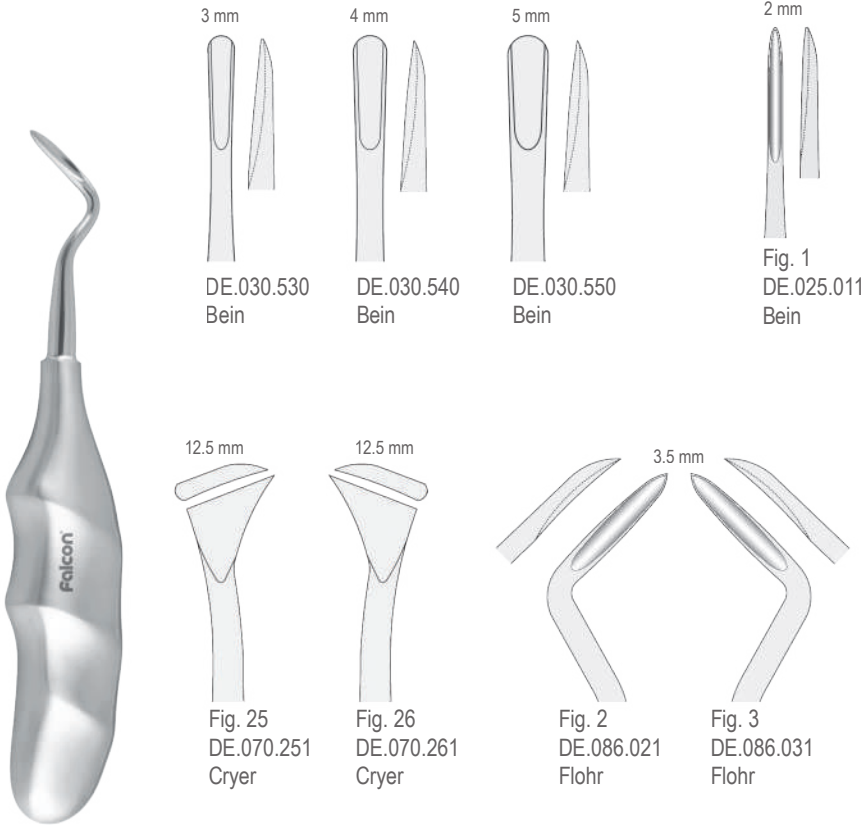

Elevators Set

- DE.999.009
Contents
1 each of
DE.030.530
DE.030.540
DE.030.550
DE.070.251
DE.070.261
DE.086.021
DE.086.031

Elevators

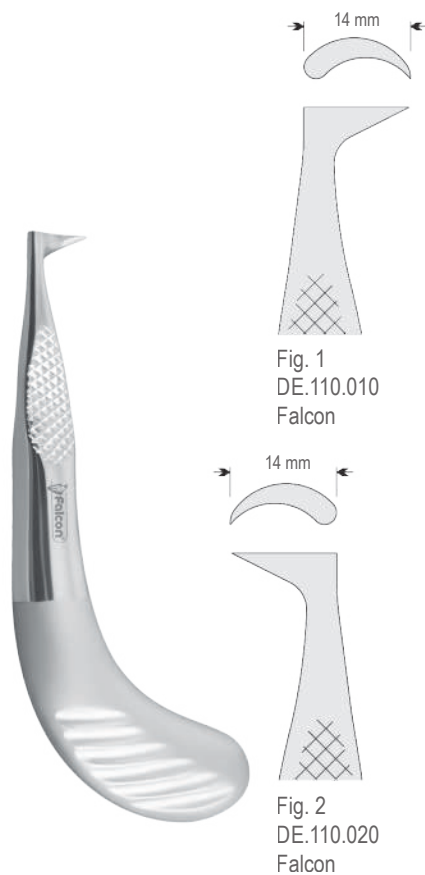

Elevators



Syndesmotomes Chompres

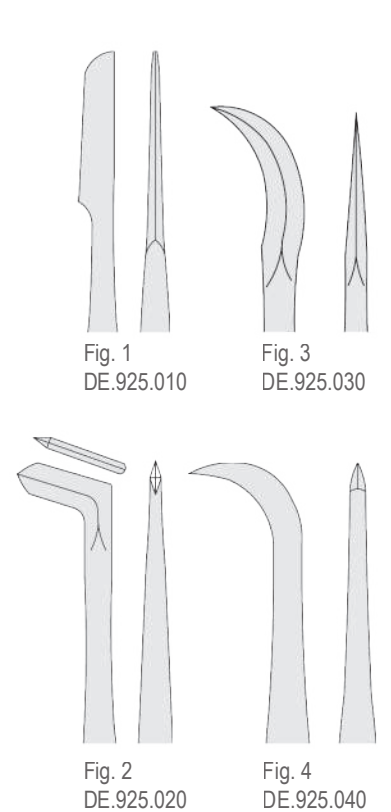

Extraction

Elevators Root Tip

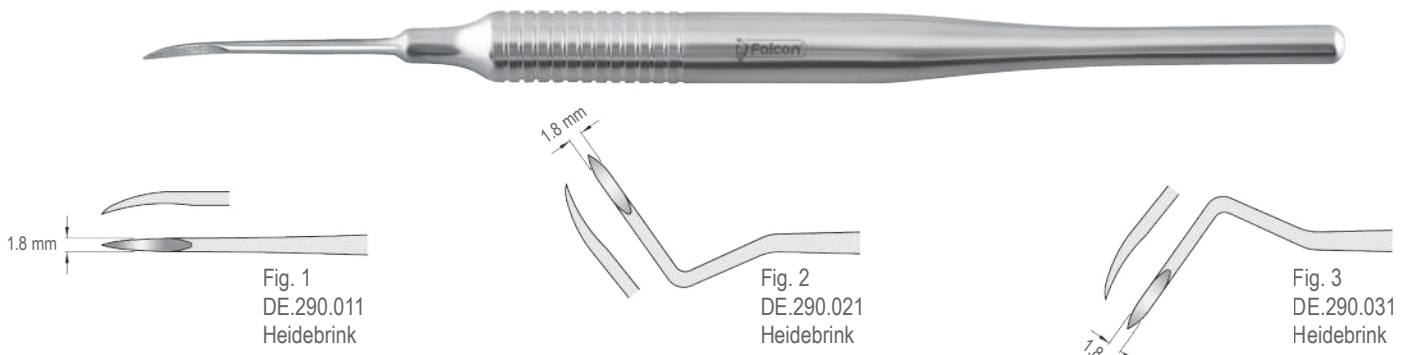

Elevators Root Tip

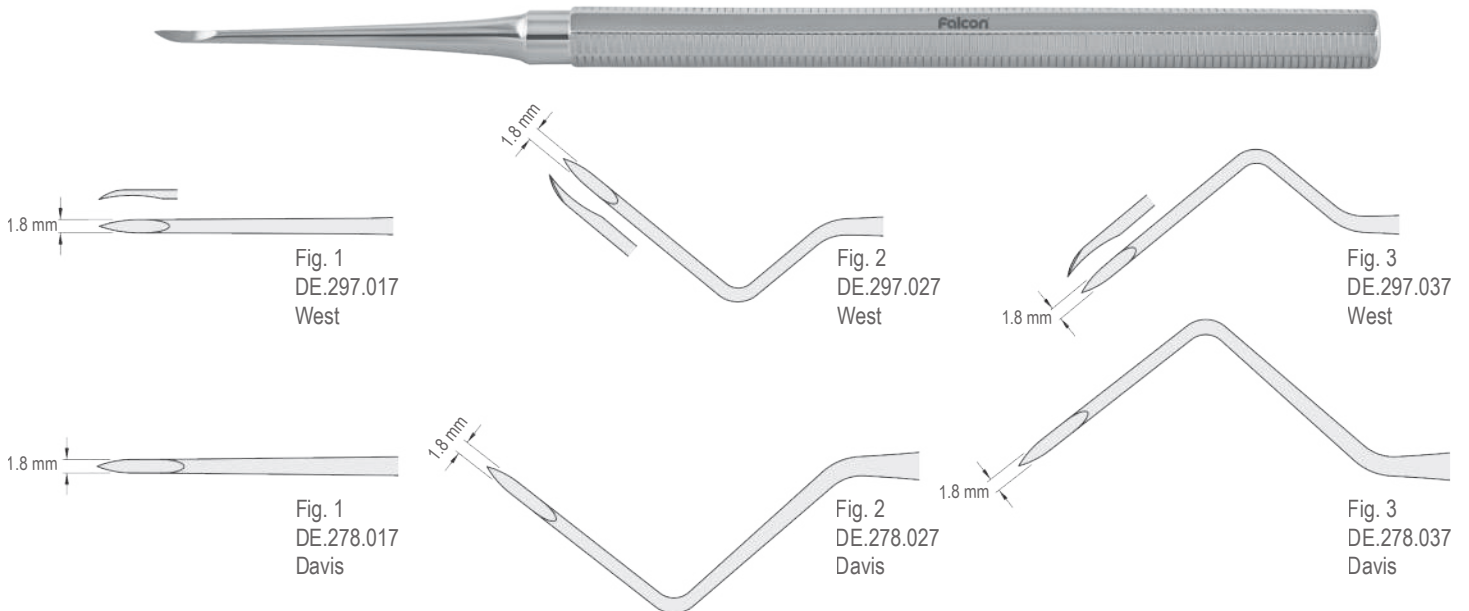

Elevators Root Tip

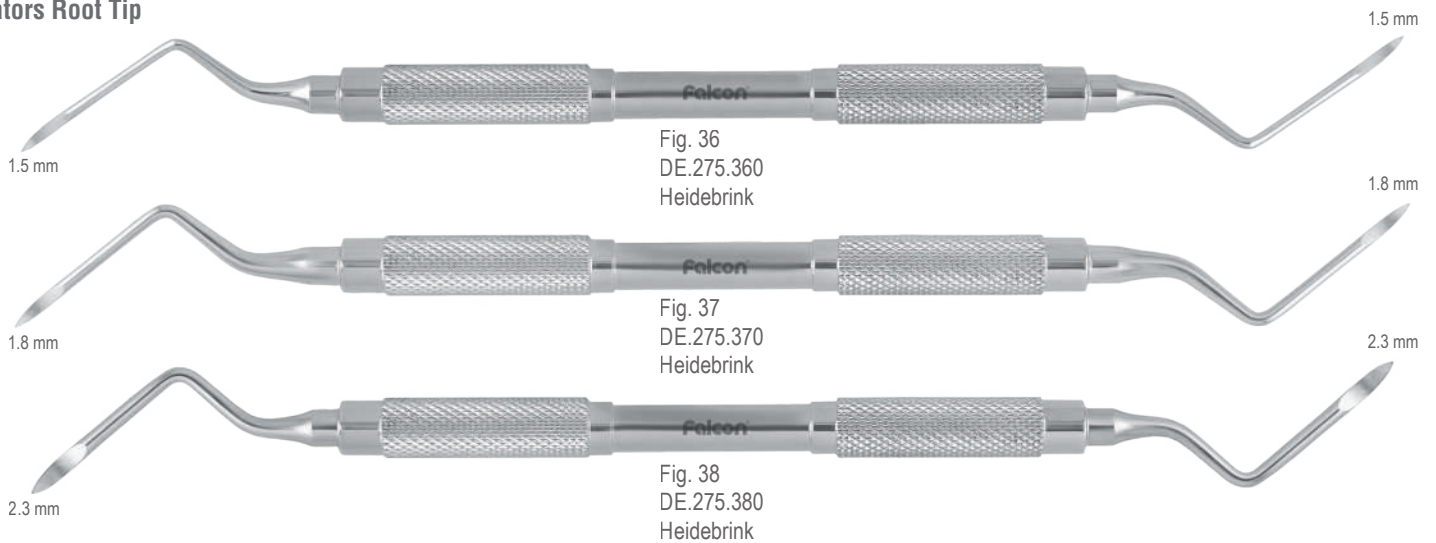

Elevators Lecluse



Fig. 1
DE.247.010

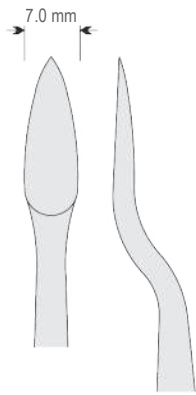

Elevators Potts

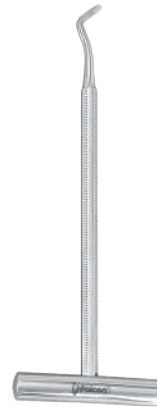

Fig. 6
DE.255.060

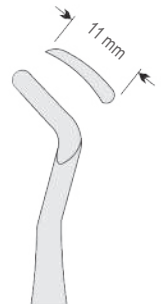

Fig. 7
DE.255.070

Elevators Winter

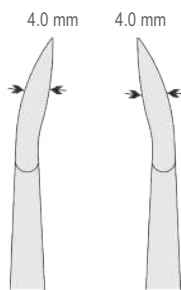
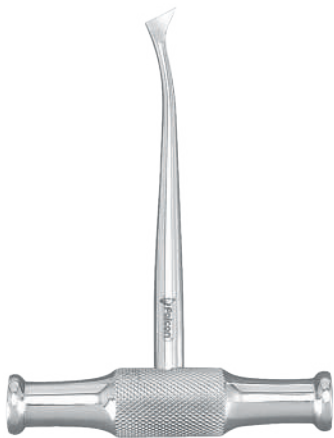

Fig. 1L
DE.270.015

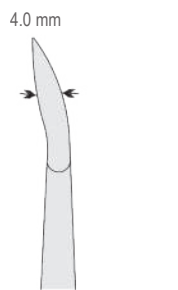

Fig. 1R
DE.270.017

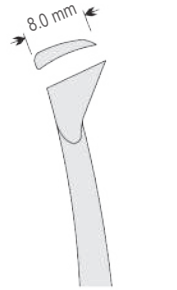

Fig. 11L
DE.270.115

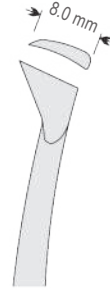

Fig. 11R
DE.270.117



Fig. 12L
DE.270.125

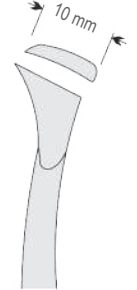

Fig. 12R
DE.270.127



Fig. 13L
DE.270.135

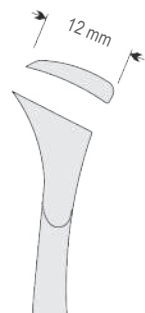

Fig. 13R
DE.270.137



Fig. 14L
DE.270.145



Fig. 14R
DE.270.147

Elevators Walter F. Barry

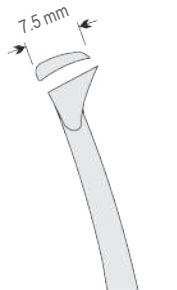

Fig. 320
DE.265.320

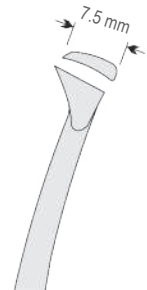

Fig. 321
DE.265.321

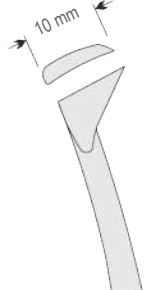

Fig. 322
DE.265.322

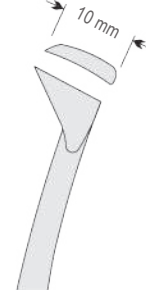

Fig. 323
DE.265.323



Fig. 350
DE.265.350

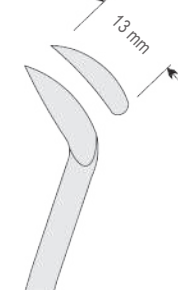

Fig. 351
DE.265.351

Extraction

Disguise Extraction Forceps - Children Pattern



Fig. 3
DE.660.030
Upper Molars



Fig. 5
DE.660.050
Lower Incisors



Fig. 6
DE.660.060
Lower Molars



Fig. 7
DE.660.070
Lower Roots



Fig. 137
DE.661.370
Upper Incisors



Fig. 51S
DE.660.517
Upper Roots



Fig. 139
DE.661.390
Upper Premolars

Disguise Extraction Forceps Set



DE.660.000
Contents 7 pieces

- DE.660.030 Fig. 3
- DE.660.050 Fig. 5
- DE.660.060 Fig. 6
- DE.660.070 Fig. 7
- DE.660.517 Fig. 51S
- DE.661.370 Fig. 137
- DE.661.390 Fig. 139

Extraction Forceps - Children Pattern

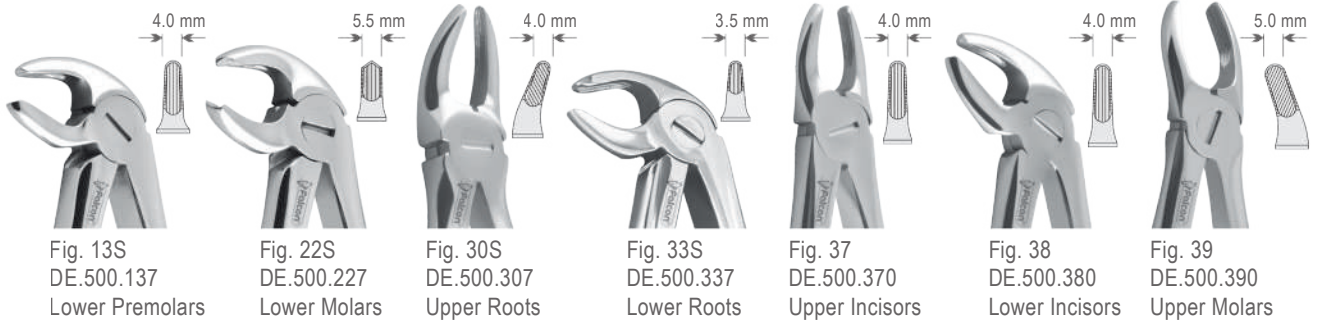

Fig. 13S
DE.500.137
Lower Premolars

Fig. 22S
DE.500.227
Lower Molars

Fig. 30S
DE.500.307
Upper Roots

Fig. 33S
DE.500.337
Lower Roots

Fig. 37
DE.500.370
Upper Incisors

Fig. 38
DE.500.380
Lower Incisors

Fig. 39
DE.500.390
Upper Molars

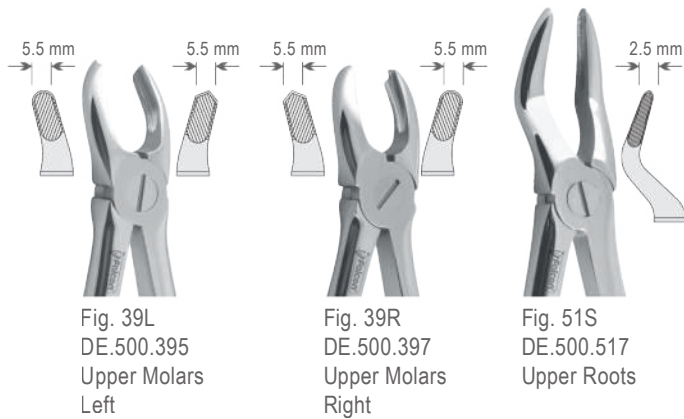

Fig. 39L
DE.500.395
Upper Molars
Left

Fig. 39R
DE.500.397
Upper Molars
Right

Fig. 51S
DE.500.517
Upper Roots

Extraction Forceps Set



DE.500.001
Contents 10 pieces

- DE.500.137 Fig. 13S
- DE.500.227 Fig. 22S
- DE.500.307 Fig. 30S
- DE.500.337 Fig. 33S
- DE.500.370 Fig. 37
- DE.500.380 Fig. 38
- DE.500.390 Fig. 39
- DE.500.395 Fig. 39L
- DE.500.397 Fig. 39R
- DE.500.517 Fig. 51S

Extraction Forceps - Children Pattern

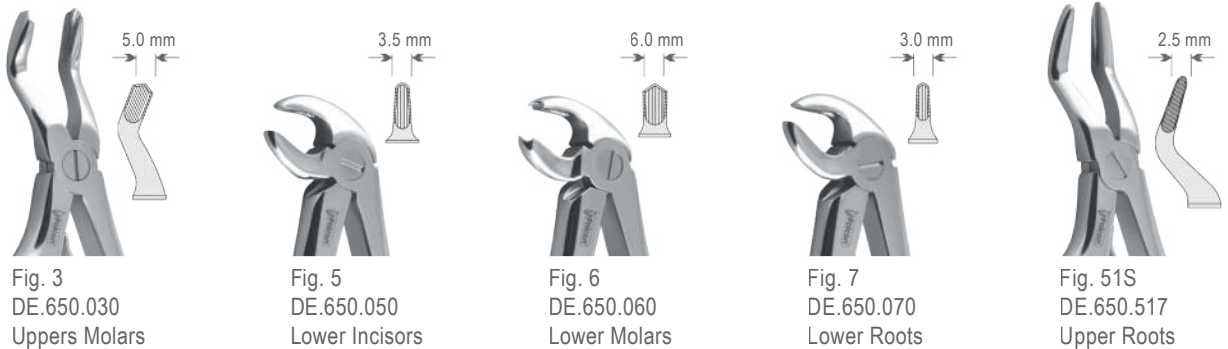

Fig. 3
DE.650.030
Uppers Molars

Fig. 5
DE.650.050
Lower Incisors

Fig. 6
DE.650.060
Lower Molars

Fig. 7
DE.650.070
Lower Roots

Fig. 51S
DE.650.517
Upper Roots

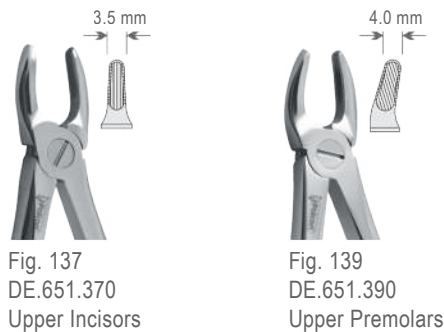

Fig. 137
DE.651.370
Upper Incisors

Fig. 139
DE.651.390
Upper Premolars

Extraction Forceps Set



DE.650.000
Contents 7 pieces

- DE.650.030 Fig. 3
- DE.650.050 Fig. 5
- DE.650.060 Fig. 6
- DE.650.070 Fig. 7
- DE.650.517 Fig. 15S
- DE.651.370 Fig. 137
- DE.651.390 Fig. 139

Instrument Sets for Extraction and Oral Surgery



DE.999.001
Set of 9 pieces

Contents

- DE.750.331 Extracting forceps fig. 33A
- DE.750.511 Extracting forceps fig. 51A
- DE.750.671 Extracting forceps fig. 67A
- DE.750.790 Extracting forceps fig. 79
- DE.086.020 Elevator Flohr left fig. 2
- DE.086.030 Elevator Flohr right fig. 3
- DE.025.060 Elevator Bein 3mm fig. 6
- DE.270.125 Elevator Winter left fig. 12L
- DE.270.127 Elevator Winter right fig. 12R



DE.999.002
Set of 9 pieces

Contents

- DE.750.331 Extracting forceps fig. 33A
- DE.750.511 Extracting forceps fig. 51A
- DE.750.671 Extracting forceps fig. 67A
- DE.750.790 Extracting forceps fig. 79
- DE.086.020 Elevator Flohr left fig. 2
- DE.086.030 Elevator Flohr right fig. 3
- DE.025.060 Elevator Bein 3mm fig. 6
- BN.414.140 Falcon-Grip Needle holder Mathieu 140mm TC
- BN.298.160 Falcon-Grip Needle holder Mayo-Hegar 160mm TC



DE.750.000
Contents 10 pieces

- DE.750.010 Fig. 1
- DE.750.070 Fig. 7
- DE.750.130 Fig. 13
- DE.750.170 Fig. 17
- DE.750.180 Fig. 18
- DE.750.220 Fig. 22
- DE.750.331 Fig. 33A
- DE.750.511 Fig. 51A
- DE.750.671 Fig. 67A
- DE.750.790 Fig. 79



DE.800.000
Contents 10 pieces

- DE.800.010 Fig. 1
- DE.800.070 Fig. 7
- DE.800.130 Fig. 13
- DE.800.170 Fig. 17
- DE.800.180 Fig. 18
- DE.800.220 Fig. 22
- DE.800.331 Fig. 33A
- DE.800.511 Fig. 51A
- DE.800.671 Fig. 67A
- DE.800.790 Fig. 79



DE.750.001
Contents 11 pieces

- DE.750.020 Fig. 2
- DE.750.070 Fig. 7
- DE.750.130 Fig. 13
- DE.750.170 Fig. 17
- DE.750.180 Fig. 18
- DE.750.220 Fig. 22
- DE.750.331 Fig. 33A
- DE.750.511 Fig. 51A
- DE.750.670 Fig. 67
- DE.750.790 Fig. 79
- DE.750.861 Fig. 86A

Extraction Forceps European Pattern

**750 SERIES
Standard**



**800 SERIES
Finger-Form**

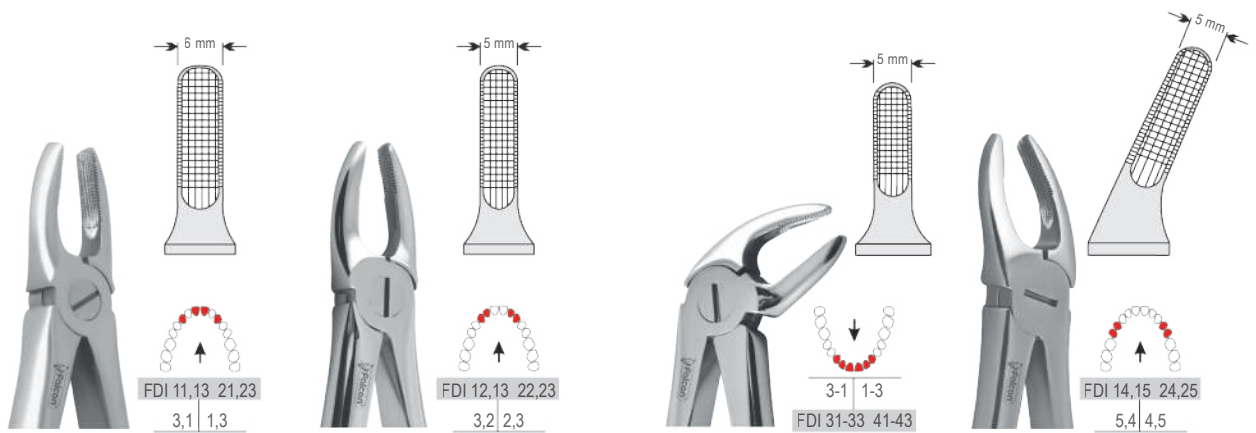

Fig. 1

DE.750.010

Fig. 2

DE.750.020

Fig. 4

DE.750.040

Fig. 7

DE.750.070

Standard

Finger-Form

Upper Centrals and
Canines/Cuspids

Upper Laterals and
Canines/Cuspids

Lower Incisors and
Canines/Cuspids

Upper Premolars/
Bicuspid

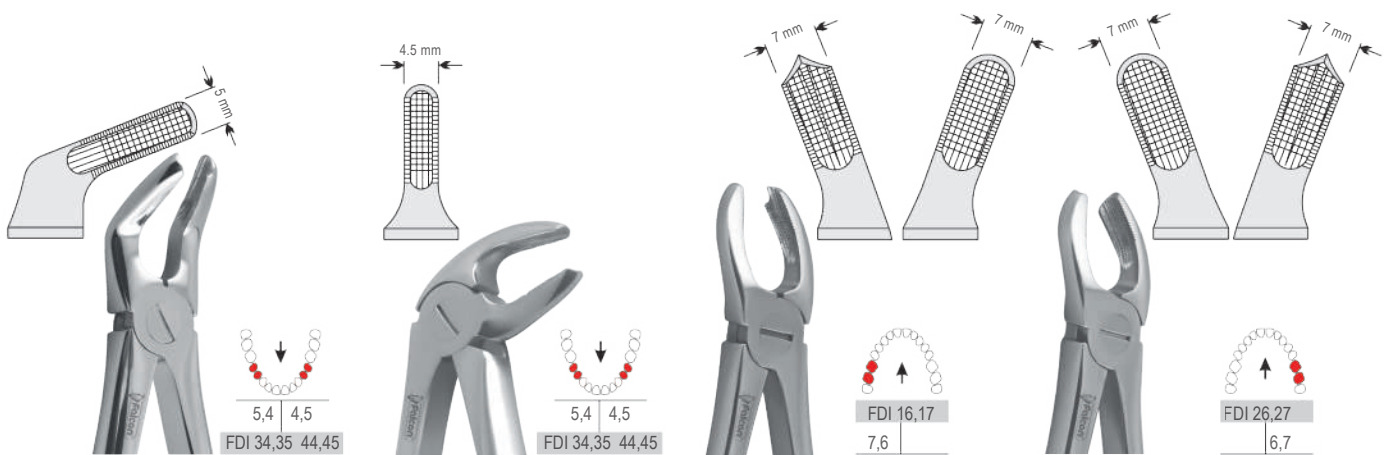

Fig. 8

DE.750.080

Fig. 13

DE.750.130

Fig. 17

DE.750.170

Fig. 18

DE.750.180

Standard

Finger-Form

Lower Premolars/Bicuspid

Lower Premolars/Bicuspid

Upper Molars, Right

Upper Molars, Left

Extraction

Extraction Forceps European Pattern

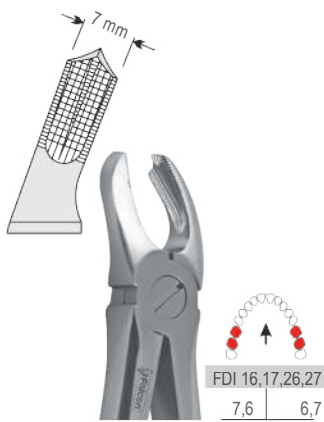

Fig. 18A

Standard DE.750.181

Finger-Form DE.800.181

Upper Molars

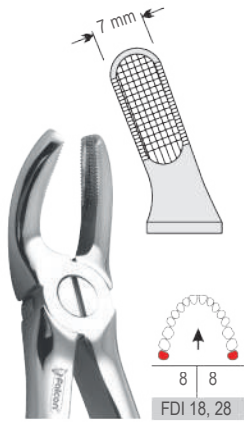

Fig. 19

DE.750.190

DE.800.190

Upper Third Molars

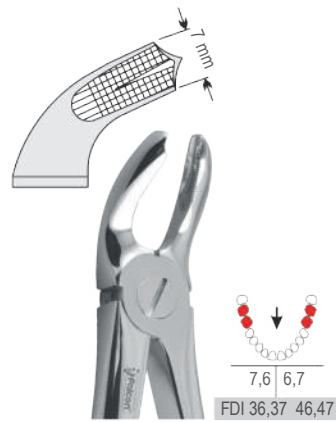

Fig. 21

DE.750.210

DE.800.210

Lower Molars

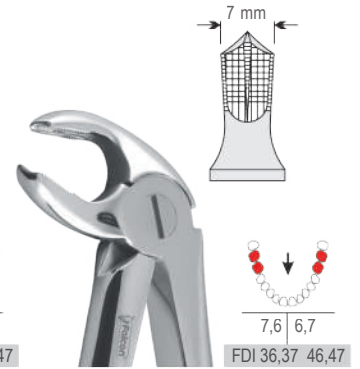

Fig. 22

DE.750.220

DE.800.220

Lower Molars



Fig. 23

Standard DE.750.230

Finger-Form DE.800.230

Lower Molars, Right



Fig. 24

DE.750.240

DE.800.240

Lower Molars, Left

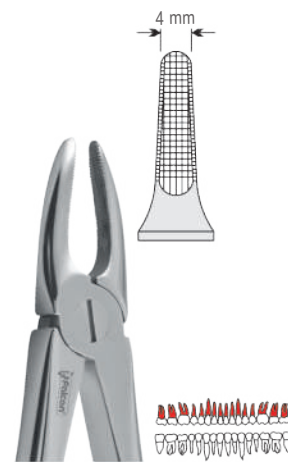

Fig. 29

DE.750.290

DE.800.290

Upper Roots

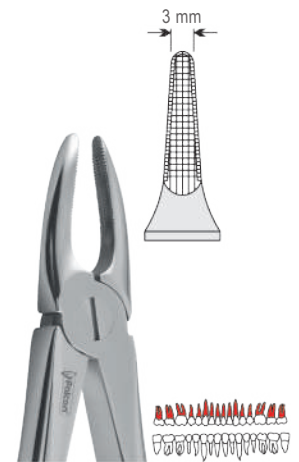

Fig. 29N

DE.750.295

DE.800.295

Upper Roots, Narrow Tips

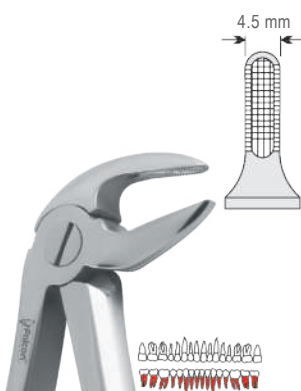

Fig. 33

Standard DE.750.330

Finger-Form DE.800.330

Lower Roots



Fig. 33A

DE.750.331

DE.800.331

Lower Roots, Narrow Tips

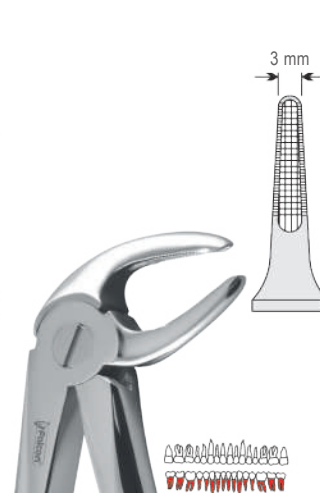

Fig. 33M

DE.750.335

DE.800.335

Lower Roots, Long Tips

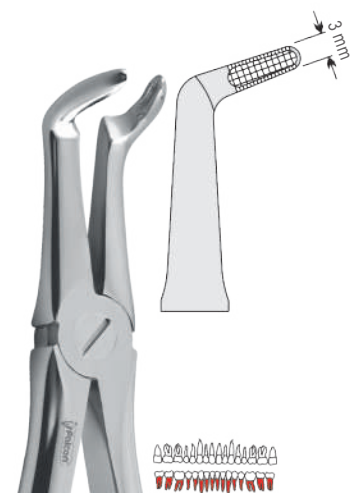

Fig. 45

DE.750.450

DE.800.450

Lower Roots

Extraction Forceps European Pattern

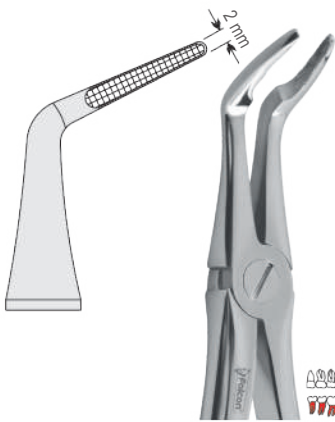

Fig. 46L

Standard DE.750.463

Finger-Form DE.800.463

Lower roots long tips

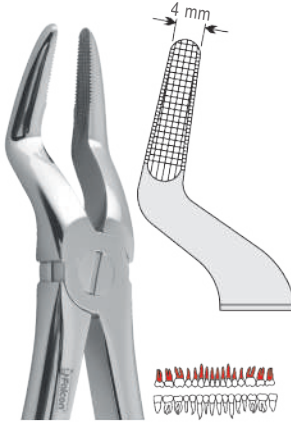

Fig. 51

Standard DE.750.510

Finger-Form DE.800.510

Upper roots

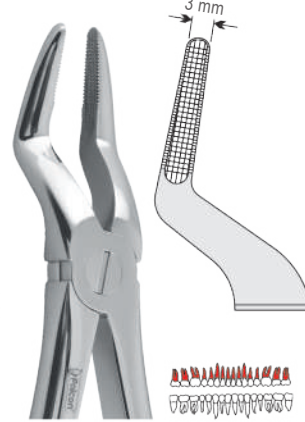

Fig. 51A

Standard DE.750.511

Finger-Form DE.800.511

Upper roots narrow tips

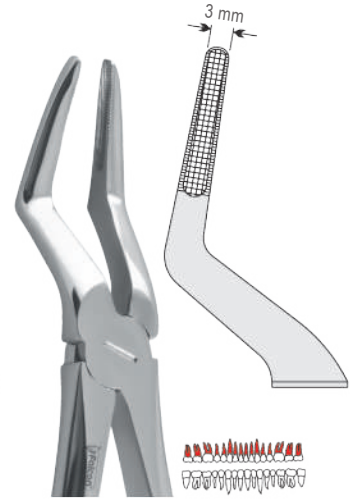

Fig. 51M

Standard DE.750.515

Finger-Form DE.800.515

Upper roots long tips

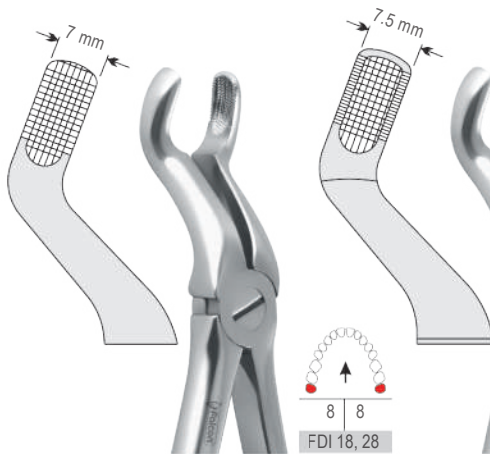

Fig. 67

Standard DE.750.670

Finger-Form DE.800.670

Upper third molars

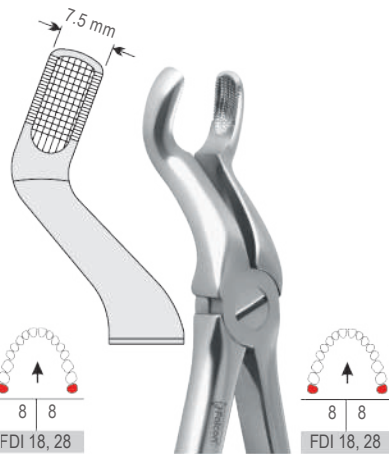

Fig. 67A

Standard DE.750.671

Finger-Form DE.800.671

Upper third molars



Fig. 73

Standard DE.750.730

Finger-Form DE.800.730

Lower molars



Fig. 74

Standard DE.750.740

Finger-Form DE.800.740

Lower roots



Fig. 74N

Standard DE.750.743

Finger-Form DE.800.743

Lower roots



Fig. 75

Standard DE.750.750

Finger-Form DE.800.750

Lower premolars/bicusps

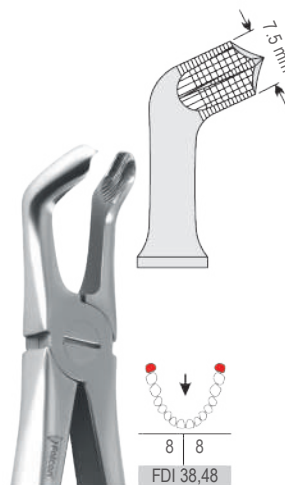

Fig. 79

Standard DE.750.790

Finger-Form DE.800.790

Lower third molars



Fig. 86A

Standard DE.750.861

Finger-Form DE.800.861

Lower molars

Extraction

Extraction Forceps European Pattern

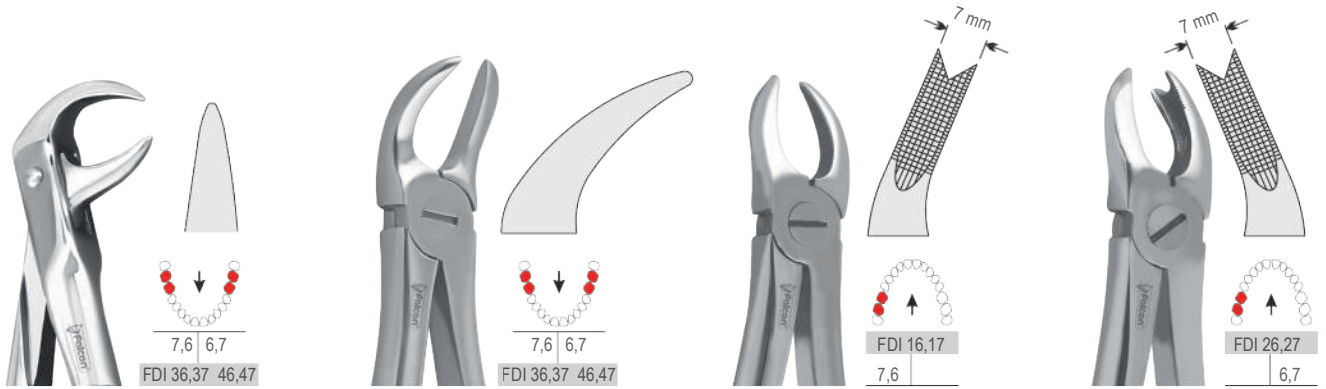

	Fig. 86C	Fig. 87	Fig. 89	Fig. 90
Standard	DE.750.863	DE.750.870	DE.750.890	DE.750.900
Finger-Form	DE.800.863	DE.800.870	DE.800.890	DE.800.900
	Upper Molars	Lower Molars	Upper Molars, Right	Upper Molars, Left

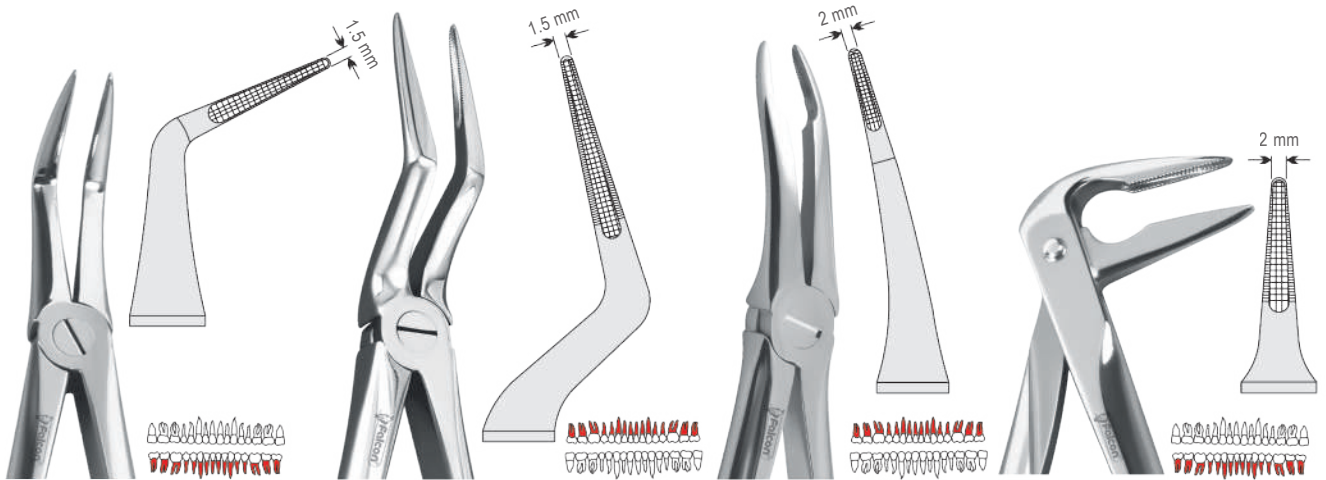

	Fig. 145	Fig. 151½	Fig. 349	Fig. 359
Standard	DE.751.450	DE.751.510	DE.753.490	DE.753.590
Finger-Form	DE.801.450	DE.801.510	DE.803.490	DE.803.590
	Lower Roots, Long Tips	Upper Roots, Long Tips	Upper Roots	Lower Roots, Long Tips

POWER - GRIP

Extraction Forceps



Fig. 1
DE.878.010 for adults
DE.877.010 for children
Upper Anteriors



Fig. 2
DE.878.020 for adults
DE.877.020 for children
Upper Left



Fig. 3
DE.878.030 for adults
DE.877.030 for children
Upper Right



Fig. 4
DE.878.040 for adults
DE.877.040 for children
Lower Universal

Extraction Forceps with Anatomical Handles

**820 SERIES
Anatomical Grip**



Fig. 2
DE.820.020
Upper Laterals and
Canines/Cuspids



Fig. 7
DE.820.070
Upper Premolars/Bicuspid



Fig. 13
DE.820.130
Lower Premolars/Bicuspid



Fig. 17
DE.820.170
Upper Molars, Right



Fig. 18
DE.820.180
Upper Molars, Left



Fig. 22
DE.820.220
Lower Molars



Fig. 33A
DE.820.331
Lower Roots



Fig. 51A
DE.820.511
Upper Roots



Fig. 67
DE.820.670
Upper Third Molars



Fig. 79
DE.820.790
Lower Third Molars



Fig. 86A
DE.820.861
Lower Molars



Fig. 86C
DE.820.863
Lower Molars



Fig. 89
DE.820.890
Upper Molars, Right



Fig. 90
DE.820.900
Upper Molars, Left



DE.820.002
1 each of
Fig. 2, 7, 13, 17, 18, 22,
33A, 51A, 67, 79, 86A

Extraction

Extraction Forceps Meissner Pattern

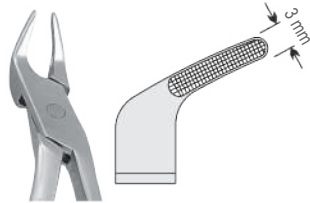

Fig. 1
DE.875.010
Meissner

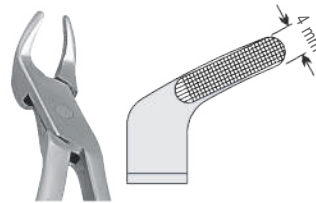
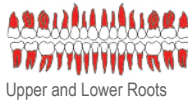

Fig. 2
DE.875.020
Meissner

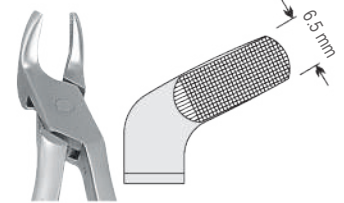
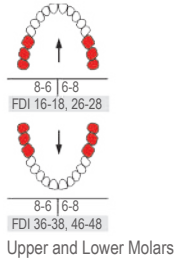

Fig. 3
DE.875.030
Meissner



Extraction Forceps Routurier Pattern



Fig. 122L
DE.881.225

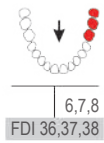
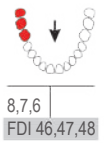

Fig. 122R
DE.881.227



Extraction Forceps

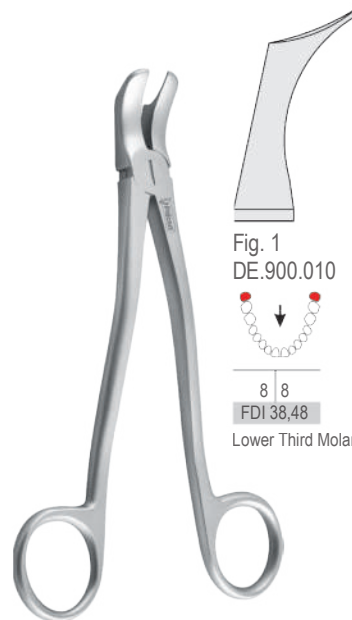

Fig. 1
DE.900.010

8 8
FDI 38,48

Lower Third Molars

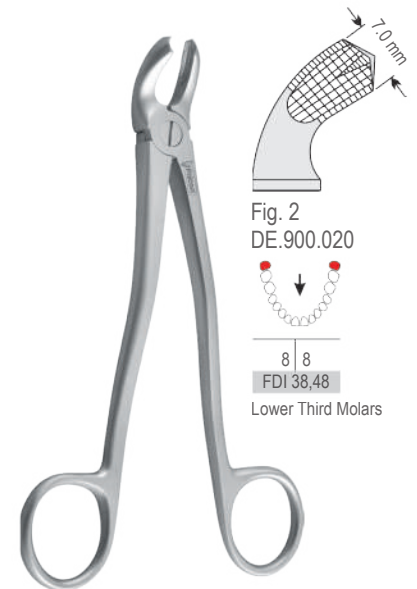

Fig. 2
DE.900.020

8 8
FDI 38,48

Lower Third Molars

Extraction Forceps Witzel Pattern



DE.898.010
Fig. 1
Witzel
Upper Roots

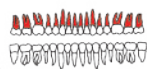

DE.898.020
Fig. 2
Witzel
Lower Roots

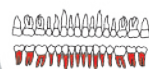

Extraction Tweezers



Fig. 1
DE.975.010
Albrecht



Fig. 2
DE.975.020
Albrecht

Air Syringe



DE.950.000

Water Syringe



DE.965.000

Retractors



DS.416.010
Uni. of Minnesota
140 mm



DS.416.011
Minnesota-Simion
135 mm



DS.416.012
Minnesota Serrated
135 mm



DS.416.013
Minnesota-Urban
135 mm



DS.416.030
Cawood-Minnesota
155 mm



DS.416.020
Cawood-Minnesota
145 mm



DS.416.040
Cawood-Minnesota
Müller
165 mm



DS.380.010
Bishop
140 mm



FC.826.100
Laster
100 mm



FC.833.155
Ward
155 mm

30 x 19 mm

33 x 25 mm



FB.330.150
Kilner
150 mm

Retractors



DS.375.020
Austin
Fig. 2



DS.375.100
Austin - Kay



FC.927.180
Boulder Henry
180 mm



FC.920.180
Shephard
180 mm



DS.405.010
Hilger



DS.405.000
Hilger
with handle



DP.714.010 Small
DP.714.020 Medium
DP.714.030 Large
Henahan



FB.310.200
Falcon
200 mm



DS.380.020
Bishop
150 mm

Dental Surgery

Retractors



DS.848.020
Falcon

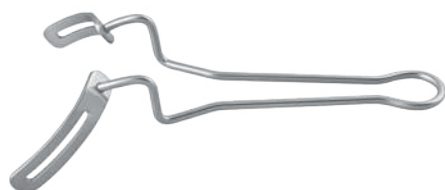

DS.848.040
Falcon

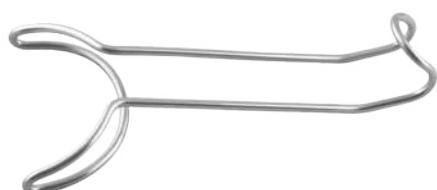

DS.848.050 85 mm
DS.848.060 75 mm
DS.848.070 65 mm
Falcon - Sternberg



DS.389.145
Columbia
145 mm



FB.430.010 120 mm
FB.430.020 140 mm
FB.430.030 150 mm
Sternberg

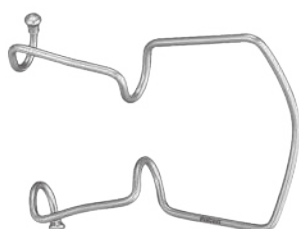

DS.427.010 100 mm
DS.427.020 105 mm
DS.427.030 115 mm
Oringer
DS.427.031
Set of 3

Mouth Props



FB.035.010 Small
FB.035.020 Medium
FB.035.030 Large

Tongue Depressors



FB.255.145
145 mm



FB.256.180
Buchwald
180 mm



FB.260.190
Bruenings
190 mm



Wieder

30 mm

36 mm

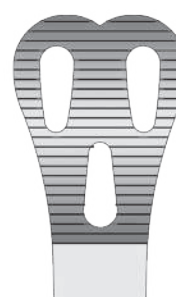

FB.298.010
140 mm

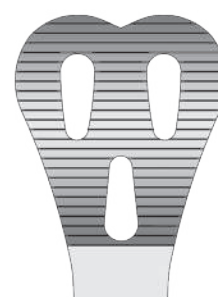

FB.298.020
140 mm

Mouth Gags



FB.060.130
Heister
130 mm



FB.065.100 100 mm
FB.065.110 110 mm
FB.065.140 140 mm
Molt



FB.085.160 160 mm
FB.085.190 190 mm
Roser-König

Periodontal Chisels

○ **CLASSIC-LITE**
10 mm hollow handle



Fig. 13K/TG DP.028.135 Kirkland



Fig. 36/37 DP.040.365 Rhodes



Fig. 1 DP.078.010 Ochenbein



Fig. 2 DP.078.020 Ochenbein



Fig. 1 DP.085.013 TG



Fig. 2 DP.085.023 TG

Periodontal Files

○ **CLASSIC-LITE**
10 mm hollow handle



Fig. 9/10 DP.345.105 Schluger



Fig. 1S/2S DP.347.025 Sugarman



Fig. 3S/4S DP.347.045 Sugarmann

Gingivectomy Knives

○ **CLASSIC-LITE**
10 mm hollow handle



Fig. 15/16 DP.469.165 Kirkland



Fig. 1/2 DP.480.025 Orban

● **Classic Round**
6 mm solid handle



Fig. 15/16 DP.469.160 Kirkland



Fig. 1/2 DP.480.020 Orban



Fig. 1 DP.500.013 Orban



Fig. 2 DP.500.023 Orban

Tunneling Instruments

These instruments for vestibular incision subperiosteal tunnel access have been designed for its unique and innovative approach to soft tissue grafting and treatment of recession defects. TIN coated.



Fig. V-1 DP.550.015T



Fig. V-2 DP.550.025T

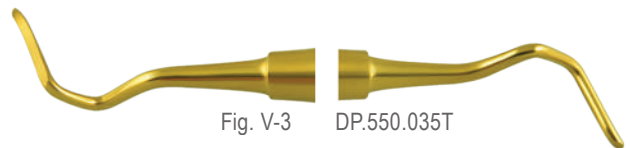

Fig. V-3 DP.550.035T

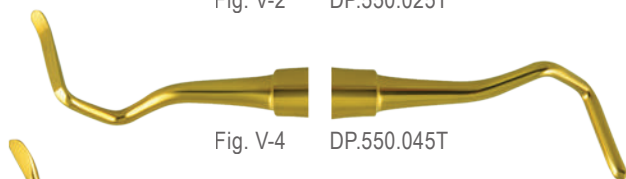

Fig. V-4 DP.550.045T

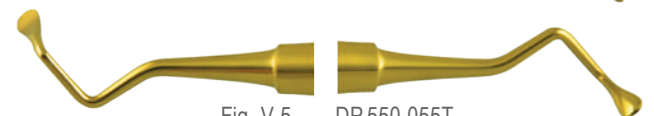

Fig. V-5 DP.550.055T

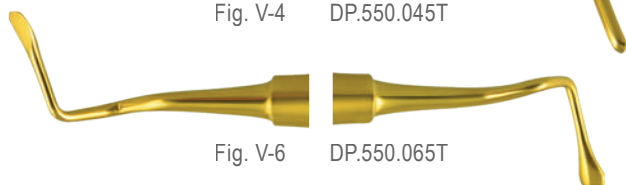

Fig. V-6 DP.550.065T

Set of 6 DP.550.000T

Titanium Periosteal Elevators



Fig. 1 DS.832.011 Busar



Fig. 3 DS.839.031 Prichard

Titanium Periosteal Elevators



Fig. 1 DS.832.015T Busar



Fig. 3 DS.839.035T Prichard

Periosteal Elevators



Fig. 9 DP.666.094 Molt



Fig. 3 DP.665.034 Prichard



Fig. 9A DS.830.091 Allen



Fig. 1 DS.832.015 Busar



Fig. 2 DS.832.025 Busar



Fig. 3 DS.832.035 Busar



Fig. 1 DS.845.015



Fig. 2 DS.845.025 Sharp-Blunt

Periosteal Elevators



Fig. 1 DS.838.015 Atraumatic papilla elevator



Fig. 7 DP.660.075 Molt



Fig. 8 DP.660.085 Molt



Fig. 9 DP.660.095 Molt



Fig. 9 DP.660.090 Molt



Fig. 9 DP.660.097S Molt



Fig. 14 DP.637.145 Goldman-Fox



Fig. 3 DP.665.035 Prichard



Fig. 3 DP.665.037 Prichard



Fig. 3 DP.658.035 Mead/West



Fig. 20 DP.640.205 Hirschfield



Fig. 1 DP.643.015 Hopkins



Fig. 2 DP.643.025 Hopkins

Periosteal Elevators



Fig. 15 DP.635.155 Freer



Fig. 16 DP.635.165 Freer



Fig. 10 DP.663.100 OHL



Fig. 21 DP.667.210 Seldin



Fig. 23 DP.667.230 Seldin



Fig. 25 DS.828.250 170 mm



DS.198.040 Williger 125 mm



DS.198.050 Williger 125 mm



FC.280.050 Williger 160 mm



FC.730.055 Williger 160 mm

Gauze Packers



DS.350.017 Luniatschek



DS.350.027 Luniatschek

Bone Currettes

SOFT LINE INSTRUMENTS
soft and sure grip

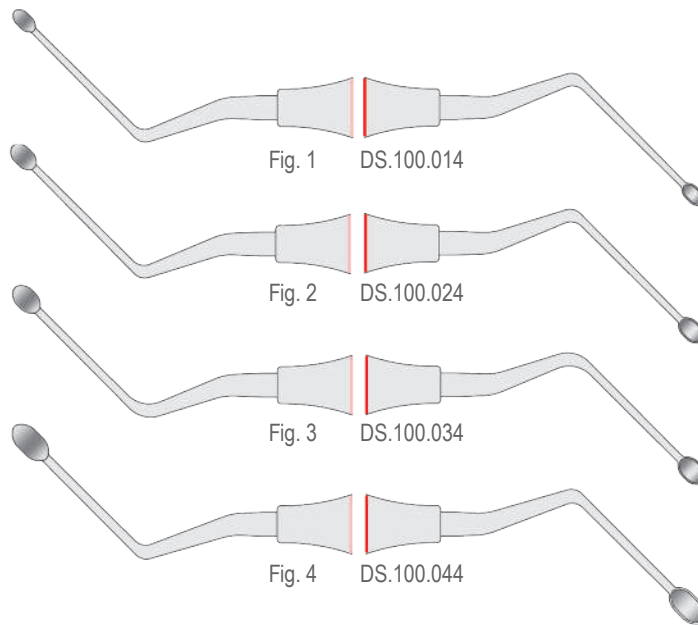

CLASSIC-LITE
9.5 mm hollow handle

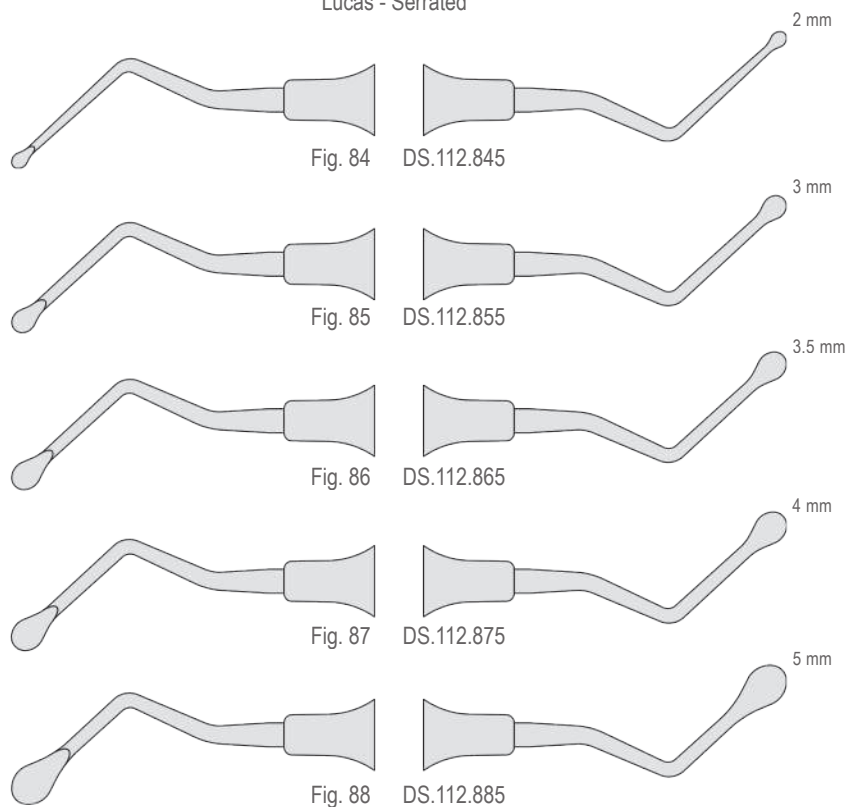
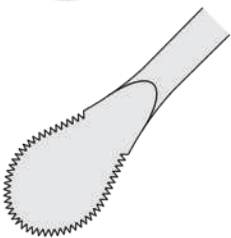

Bone Curettes

○ CLASSIC-LITE 10 mm hollow handle

● ClassicRound 6 mm solid handle

● Classic-8 5.5 mm solid handle



Hemingway

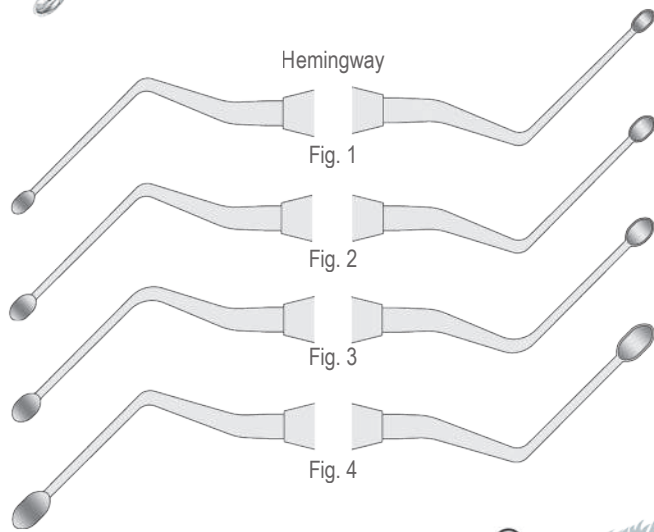

	ClassicRound 6 mm solid handle	CLASSIC-LITE 10 mm hollow handle	Classic-8 5.5 mm solid handle
Fig. 1	DS.100.010	DS.100.015	DS.100.017
Fig. 2	DS.100.020	DS.100.025	DS.100.027
Fig. 3	DS.100.030	DS.100.035	DS.100.037
Fig. 4	DS.100.040	DS.100.045	DS.100.047

○ CLASSIC-LITE 10 mm hollow handle

● ClassicRound 6 mm solid handle

● Classic-8 5.5 mm solid handle



Lucas

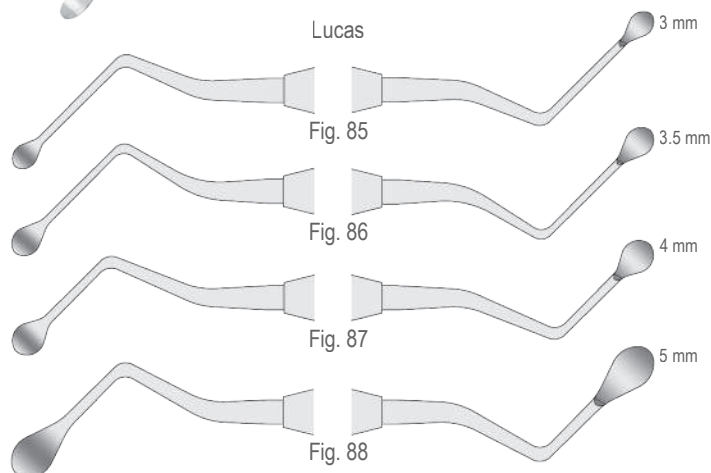

	ClassicRound 6 mm solid handle	CLASSIC-LITE 10 mm hollow handle	Classic-8 5.5 mm solid handle
Fig. 85	DS.110.850	DS.110.855	DS.110.857
Fig. 86	DS.110.860	DS.110.865	DS.110.867
Fig. 87	DS.110.870	DS.110.875	DS.110.877
Fig. 88	DS.110.880	DS.110.885	DS.110.887

Bone Curettes

● Classic-8 5.5 mm solid handle

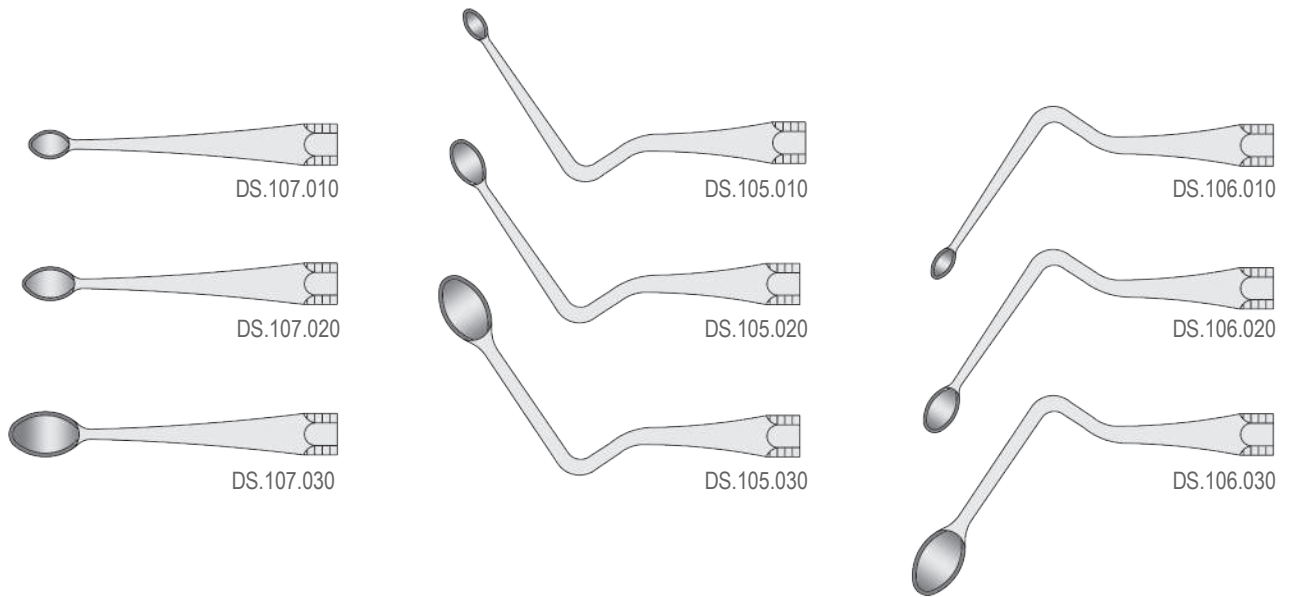

Bone Curettes



Molt
165 mm

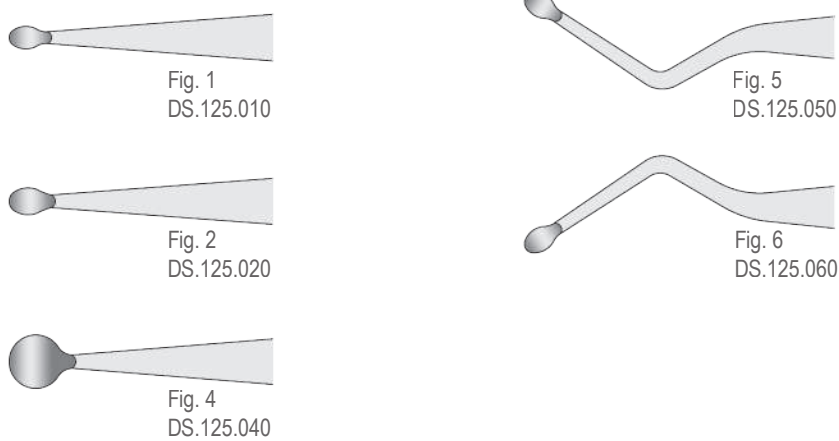

Bone Curettes



Williger
140 mm

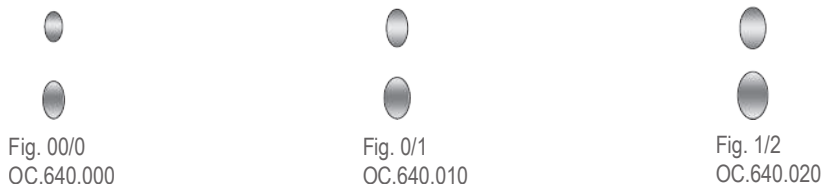

Bone Files

○ CLASSIC-LITE
10 mm hollow handle



Fig. 10 DS.200.100



Fig. 12A DS.200.121



Fig. 33 DS.200.330



Fig. 12 DS.210.120 Howard



Fig. 45 DS.220.450 Miller

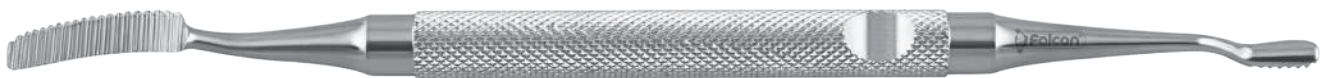

Fig. 64 DS.220.640 Miller

Bone Files



DS.221.010 Miller



DS.221.020 Miller

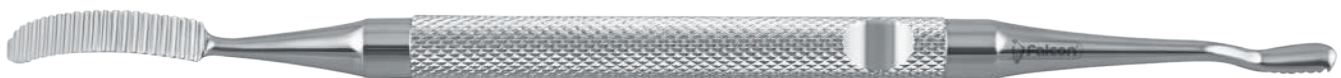

DS.221.030 Miller

Bone Rongeurs



OR.740.125
Friedmann-Mini
125 mm



OR.741.140
Friedmann
140 mm



OR.770.150
Luer
150 mm



Friedmann-Micro

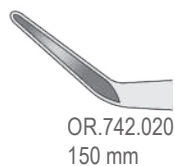

OR.742.020
150 mm

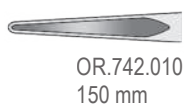

OR.742.010
150 mm



OR.742.030
145 mm

Bone Rongeurs



OR.742.040
Friedmann-Micro
150 mm



Blumenthal

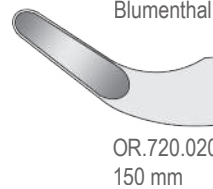

OR.720.020
150 mm

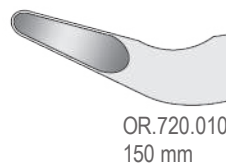

OR.720.010
150 mm

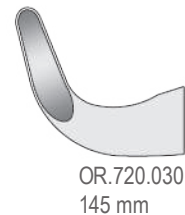

OR.720.030
145 mm



OR.775.165
Mead
165 mm



OR.820.180
Beyer
180 mm

Chisels and Gouges

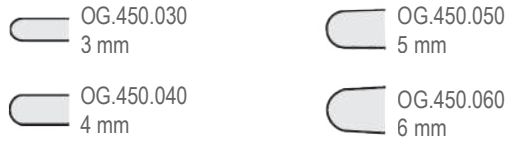
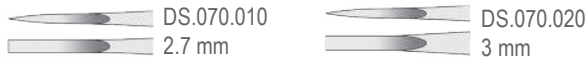

Mallets

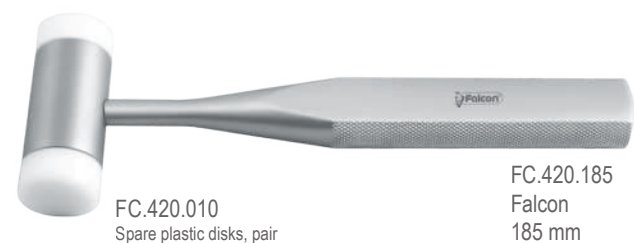
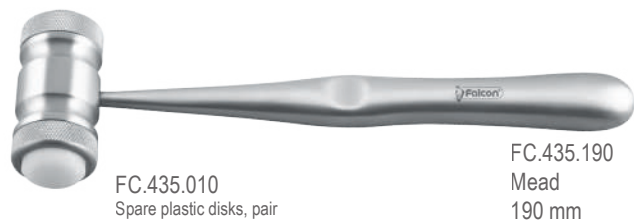

Bone Cutters



Suture Forceps

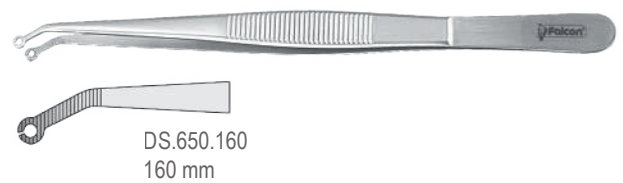

Pocket Markers



Implantology

Depth Measuring Probes

Easy
COLOR



DS.800.010
Titanium tip, silicone handle and laser marked

CLASSIC-LITE
10 mm hollow handle



DS.800.015
Titanium tip

Implant Caliper

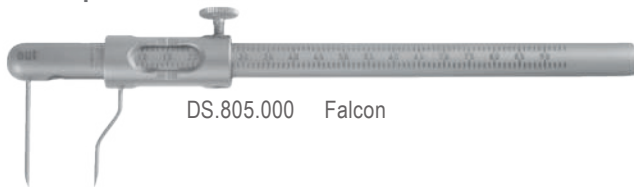

DS.805.000 Falcon

Bone Thickness Gauges



Fig. 1
DS.804.010
Castroviejo



Fig. 2
DS.804.020
Castroviejo



Fig. 3
DS.804.030
Castroviejo



Fig. 4
DS.804.040
Castroviejo



Fig. 5
DS.804.050
Castroviejo

Sinus Rongeur

Delicate bone cutting forceps for opening the sinus window 4mm bite, TIN coated.



DS.929.010
Falcon

TIN Coated Bone Block Clamps

To hold and stabilize block graft against recipient site while placing screws. Slotted tips act as a guide for precise drilling.

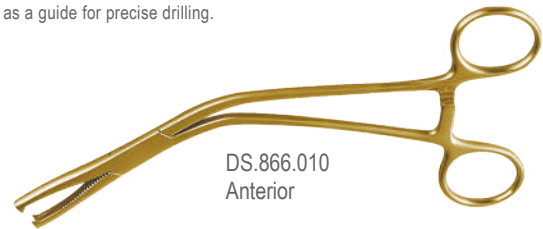

DS.866.010
Anterior



DS.866.020
Posterior

Bone Scrapers



DS.849.010
Stainless steel bone scraper straight, complete with one blade.

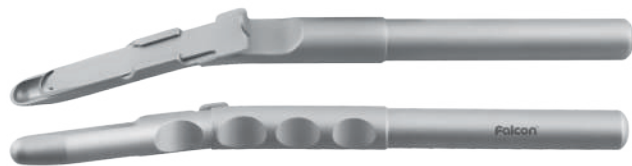

DS.849.020
Stainless steel bone scraper angled, complete with one blade.



DS.849.030
Stainless steel universal blade for straight or curved bone scraper.

Bone Collectors



DS.854.001 Ø 7 mm

DS.854.011 Ø 7 mm
Disposable stainless steel cartridge
Pack of 10 pieces

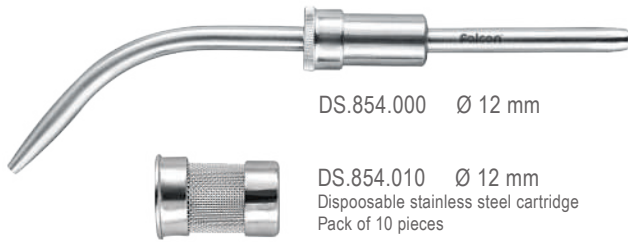

DS.854.000 Ø 12 mm

DS.854.010 Ø 12 mm
Disposable stainless steel cartridge
Pack of 10 pieces

Bone Injectors

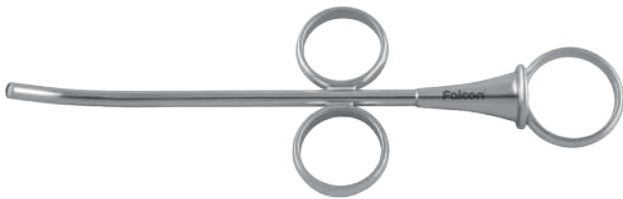

Fig. 1
DS.855.011

Fig. 3
DS.855.031

Fig. 2
DS.855.021

Fig. 4
DS.855.041

Bone Well



DS.853.010

Bone Mill / Morselizer



DS.851.010

Bone Mill



Titanium
Titanio

DS.851.040
Titanium
Ø 50/40 mm



DS.851.050
Stainless steel
Ø 50/40 mm

DS.851.060
Stainless steel
Ø 45/38 mm

Mallets



DS.273.010
Spare plastic disks, pair

DS.273.190
Falcon
190 mm
Light weight for use with implant osteotomes

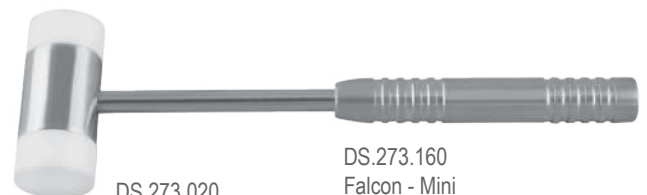

DS.273.020
Spare plastic disks, pair

DS.273.160
Falcon - Mini
160 mm

Ostetomes

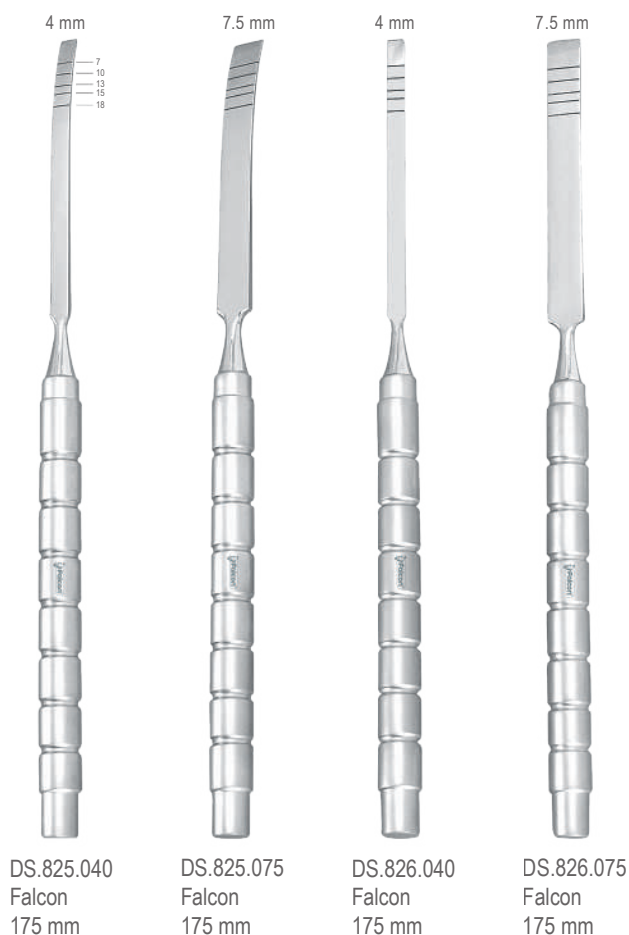

Ostetomes

Ergo-form Osteotomi

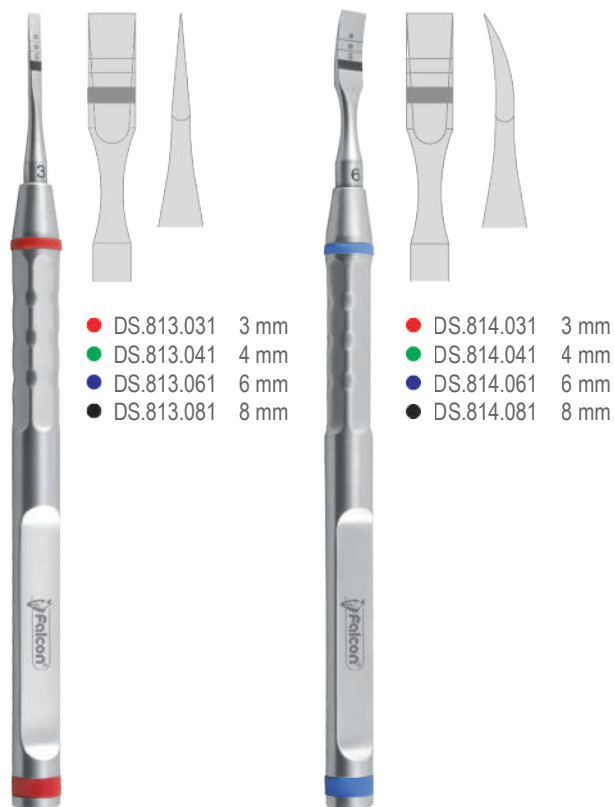

Bone Condensing Osteotomes

Tapered Convex Tips

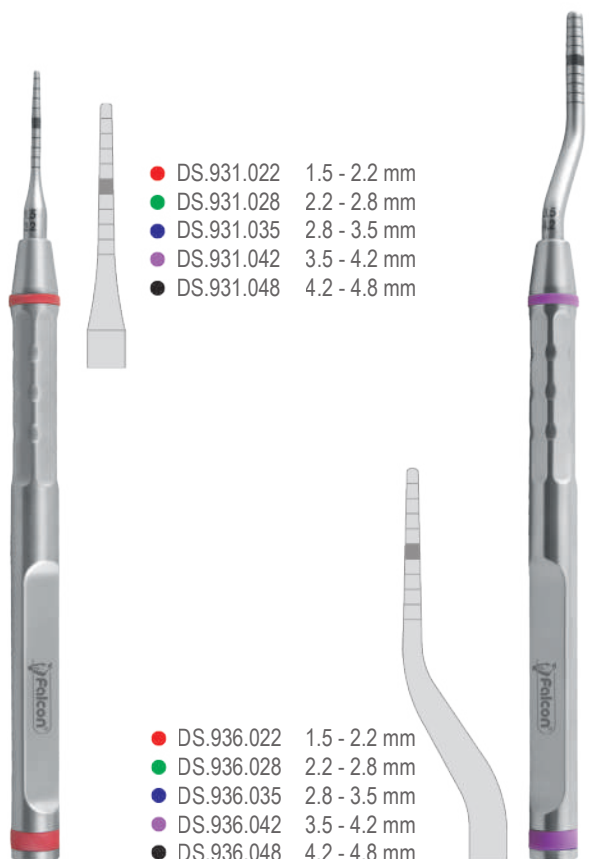

Sinus Lift Osteotomes

Straight Concave Tips

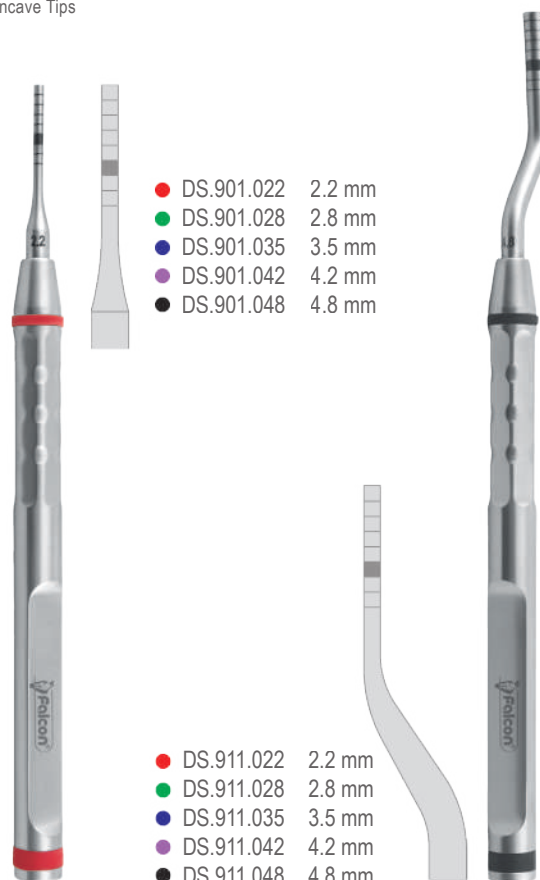

Osteotomes with Stop Concave
Ergo-form Osteotomi



DS.901.122	DS.901.128	DS.901.135	DS.901.142	DS.901.148	DS.911.122	DS.911.128	DS.911.135	DS.911.142	DS.911.148
2.2 mm	2.8 mm	3.5 mm	4.2 mm	4.8 mm	2.2 mm	2.8 mm	3.5 mm	4.2 mm	4.8 mm
Red	Green	Blue	Purple	Black	Red	Green	Blue	Purple	Black

Osteotomes with Stop Convex



DS.931.122	DS.931.128	DS.931.135	DS.931.142	DS.931.148	DS.936.122	DS.936.128	DS.936.135	DS.936.142	DS.936.148
1.5-2.2 mm	2.2-2.8 mm	2.8-3.5 mm	3.5-4.2 mm	4.2-4.8 mm	1.5-2.2 mm	2.2-2.8 mm	2.8-3.5 mm	3.5-4.2 mm	4.2-4.8 mm
Red	Green	Blue	Purple	Black	Red	Green	Blue	Purple	Black

○ CLASSIC-LITE
10 mm hollow handle



Sinus Lift Elevators



Fig. 1
DS.873.015
Falcon



Fig. 2
DS.873.025
Falcon



Fig. 3
DS.873.035
Falcon



Fig. 4
DS.873.045
Falcon



Fig. 5
DS.873.055
Falcon



Fig. 6
DS.873.065
Falcon



Fig. 7
DS.873.075
Falcon

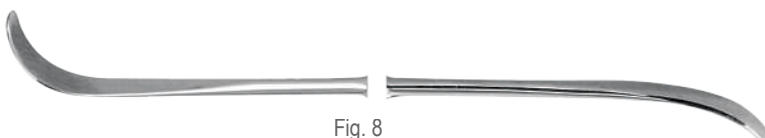

Fig. 8
DS.873.085
Falcon

Sinus Lift Curettes



Fig. 1
DS.872.015
Falcon

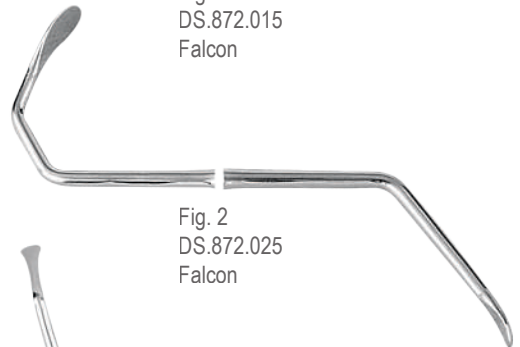

Fig. 2
DS.872.025
Falcon



Fig. 3
DS.872.035
Falcon

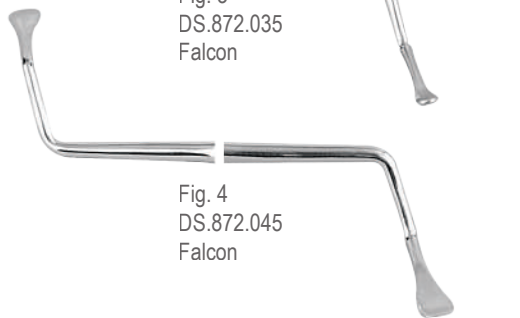

Fig. 4
DS.872.045
Falcon



Fig. 5
DS.872.055
Falcon

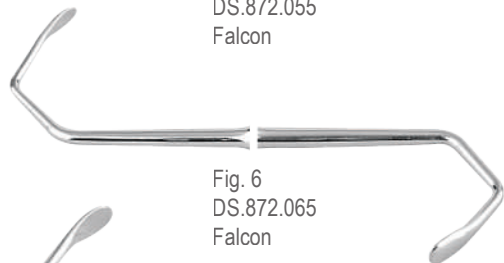

Fig. 6
DS.872.065
Falcon



Fig. 7
DS.872.075
Falcon

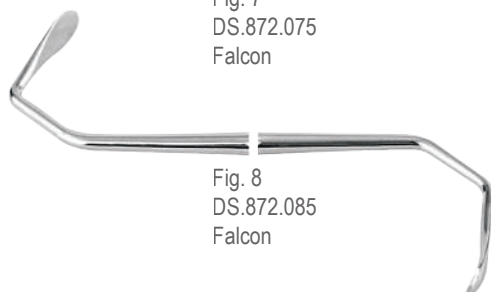

Fig. 8
DS.872.085
Falcon

Sinus Lift Instruments



DS.874.015T



DS.874.025T



DS.874.035T



DS.874.045T



DS.874.005T
Set of 4 pieces
Conf. 4 pezzi

Applicators for Bone Grafting Material



DS.863.015
Applicator



DS.864.015
Applicator and compactor

Compactors



DS.865.015



DS.865.025

Membrane Placement Instruments



DS.867.015



DS.868.010 110 mm

Implant Scaling Instruments

Easy
COLOR

Titanium
Titanium

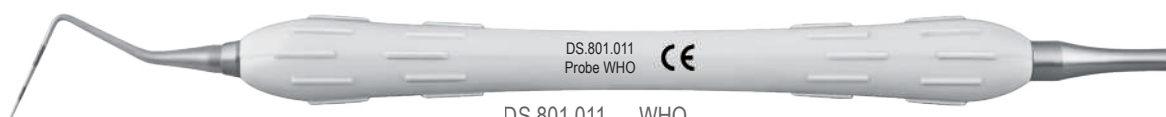

DS.801.011 WHO



Fig. 4L/4R DS.801.201 Columbia



DS.801.999
Implant scaling instrument kit 4 pieces, one of each type and tray



Fig. 204S DS.801.601



Fig. 6/7 DS.801.701 Hygienist

Soft Brushes

The concept of the Soft Brushing is to disorganize the collagen fibers of the fibrous periosteum: the stiffness is reduced and the flap release increases just by using the brushes. The brush tools do not cut anything. The flap release is the result of the separation of the periosteum fibers.



Fig. 1
DP.980.015T
Regular straight



Fig. 3
DP.980.035T
Regular right



Fig. 2
DP.980.025T
Regular left

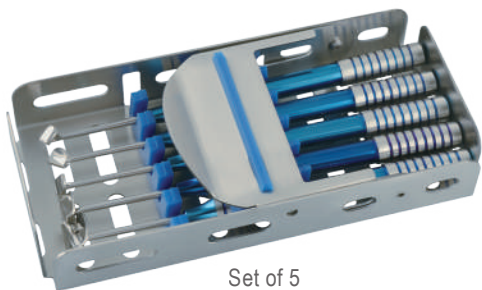

Set of 5
DP.980.000T

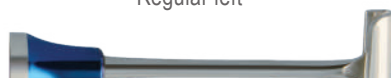

Fig. 4
DP.980.045T
Medium straight



Fig. 5
DP.980.055T
X-Large straight

Micro Scalpel Blade Handles

Safety Model 

BM.042.100 100 mm
BM.042.130 130 mm



BM.044.100 100 mm



BM.047.130 130 mm

Micro Scissors Stainless Steel



Noyes / Castroviejo



BS.505.120
120 mm



BS.504.120
120 mm



BS.506.115
115 mm

Micro Scissors Stainless Steel

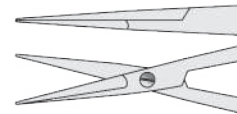

BM.180.150
150 mm

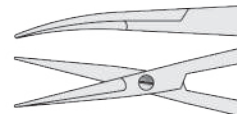

BM.181.150
150 mm

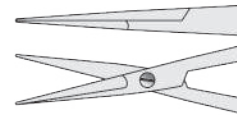

BM.180.180
180 mm

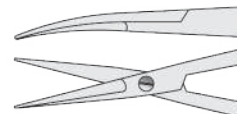

BM.181.180
180 mm

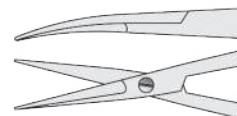

BM.183.180
180 mm
Micro scissors for ligature,
one blade serrated

Micro Instruments

Micro Forceps Stainless Steel

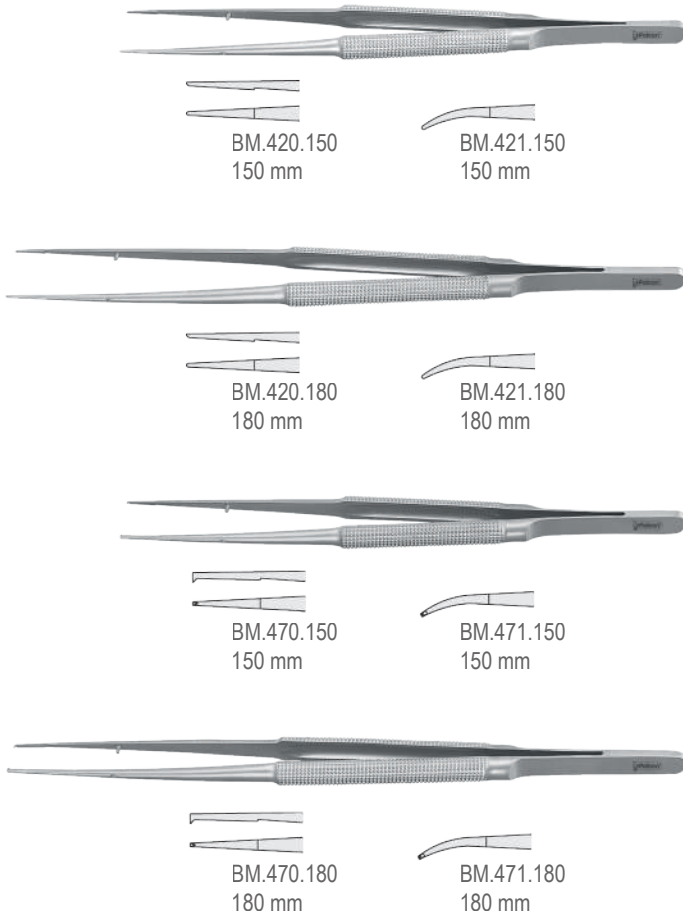

Fig. 2
BD.904.020
110 mm



Fig. 3
BD.904.030
110 mm



Fig. 4
BD.904.040
110 mm



Fig. 5
BD.904.050
110 mm



Fig. 5A
BD.904.055
110 mm

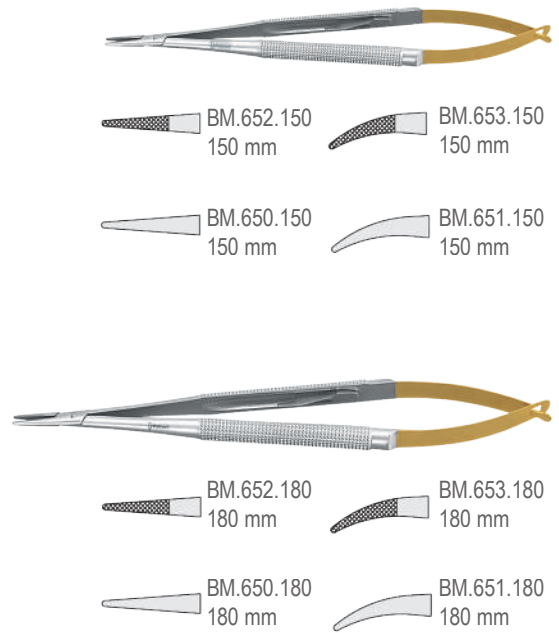

Fig. 7
BD.904.070
110 mm

Micro Needle Holders Stainless Steel



With Tungsten Carbide Inserts



BM.700.150
150 mm BM.701.150
150 mm



BM.700.180
180 mm BM.701.180
180 mm

Micro Needle Holders Stainless Steel

Scalpel handles

For scalpel blades no. : 10, 11, 12, 12D, 13, 15, 15C



BK.742.015 Falcon 360°



BK.600.050 Fig. 5



BK.610.050 Fig. 5S



BK.612.050 Fig. 5



BK.613.050 Fig. 5A



BK.552.030 Fig. 3G



BK.550.030 Fig. 3



BK.584.070 Fig. 7K



BK.580.070 Fig. 7

For scalpel blades no. : 20, 21, 22, 23, 24, 25



BK.650.040 Fig. 4

Blade Remover



BK.750.150
Falcon
150 mm

Scalpels



BK.150.040 35 mm
BK.150.050 40 mm
BK.150.060 45 mm
BK.150.070 50 mm

Surgery Instruments

Scissors with Tungsten Carbide Inserts

Key Features:

- Extremely smooth cutting with less trauma.
- Manufactured from high quality stainless steel and tungsten carbide inserts for longer-lasting cutting edge.
- Gold plated rings.

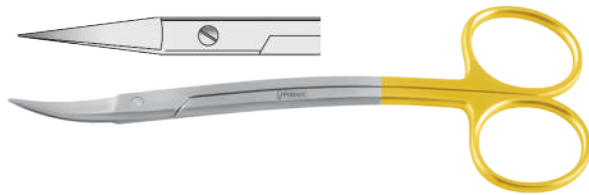

BS.107.115
La Grange
115 mm

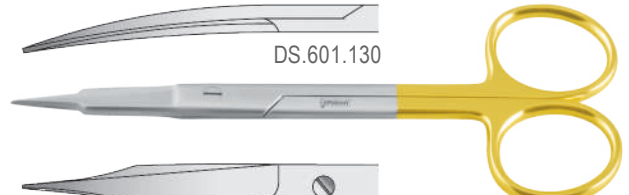

DS.601.130

Goldman-Fox
130 mm

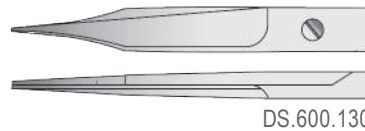

DS.600.130

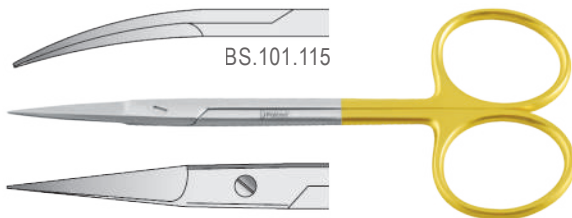

BS.101.115

Iris
115 mm



BS.100.115

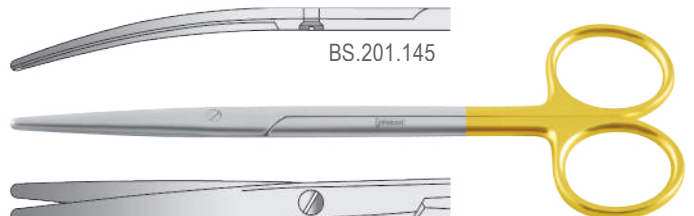

BS.201.145

Metzenbaum
145 mm



BS.200.145

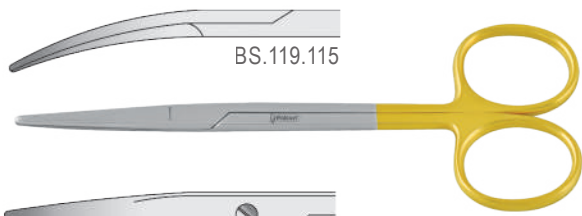

BS.119.115

Strabismus
115 mm



BS.118.115

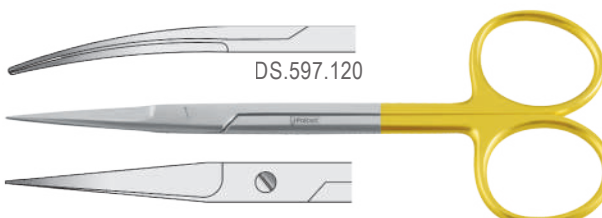

DS.597.120

Falcon
120 mm



DS.596.120

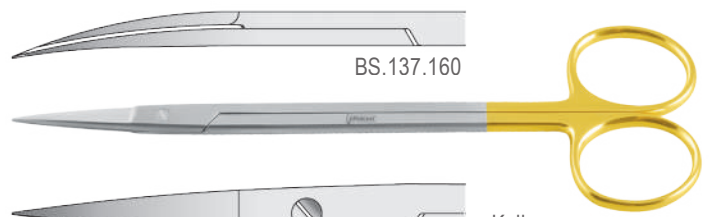

BS.137.160

Kelly
160 mm

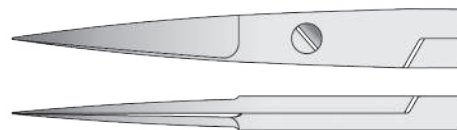

BS.136.160

Super-Cut Scissors

- Cutting blade horned to "razor" sharpness with opposing blade finished with fine serrations to avoid tissue slippage.
- Extremely smooth cutting with less trauma.

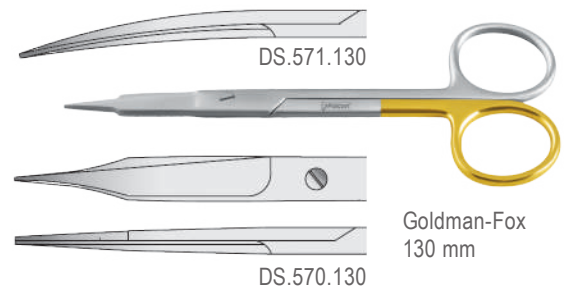
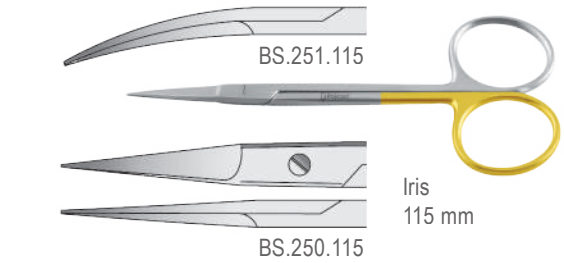
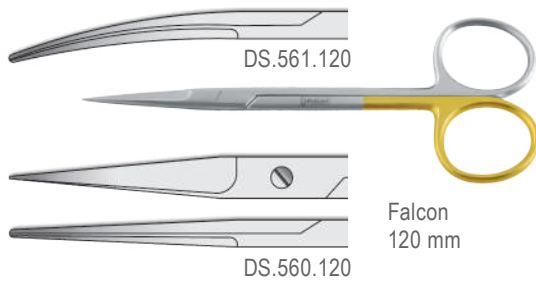
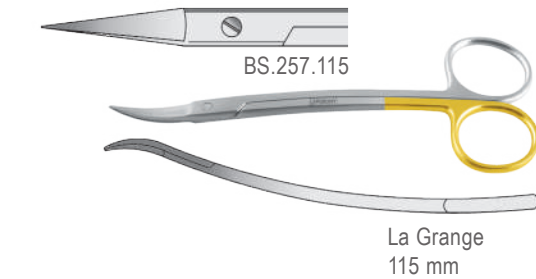

Scissors, One Blade Serrated

- One blade is with fine serrations to avoid tissue or ligature slippage.

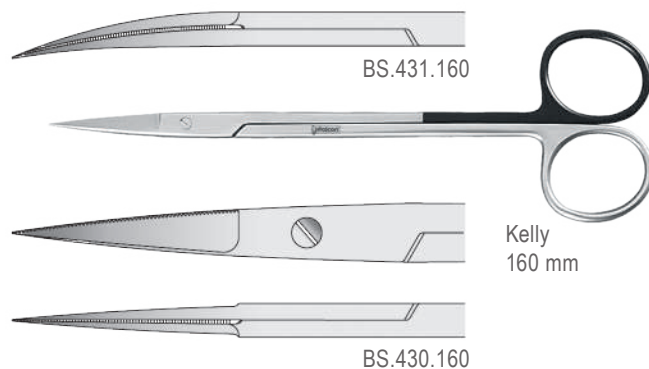
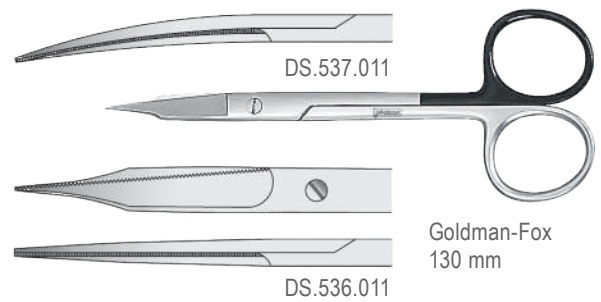

Gum and Operating Scissors

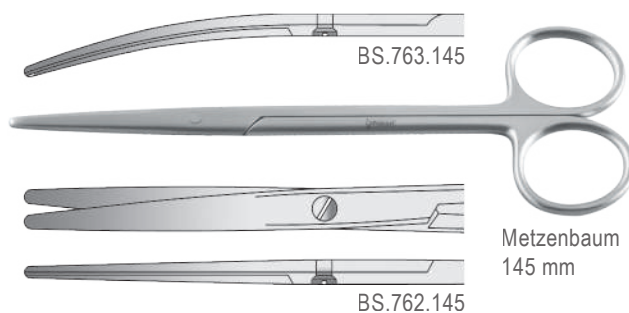
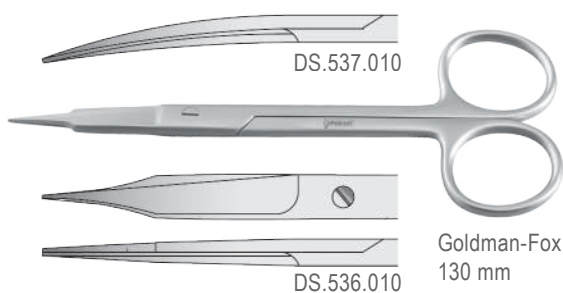
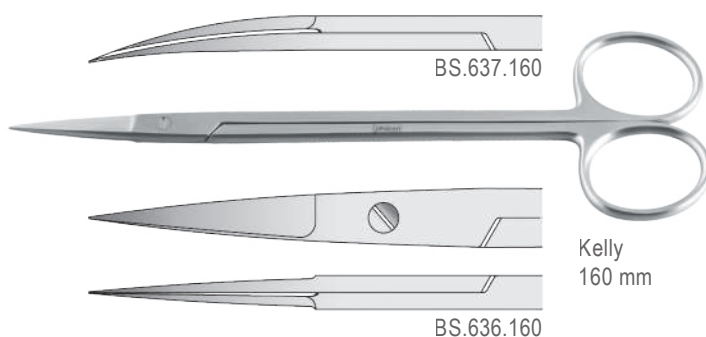
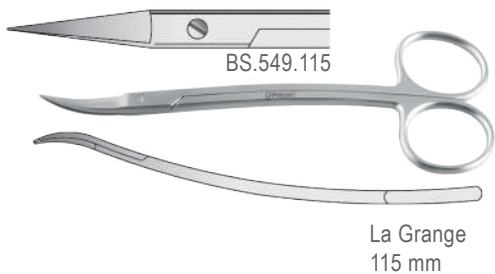

Operating Scissors

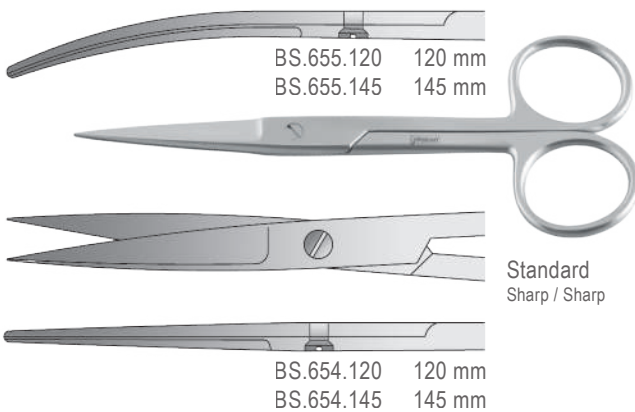
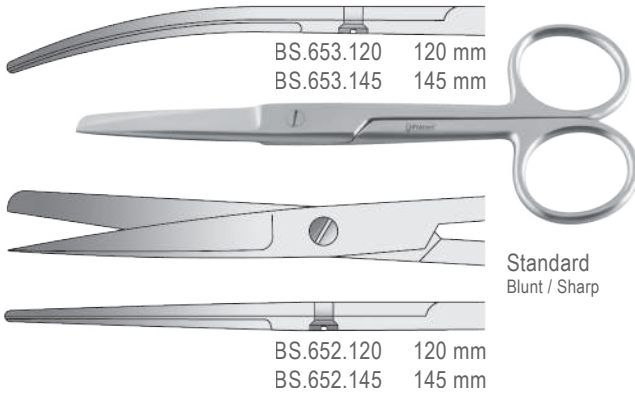
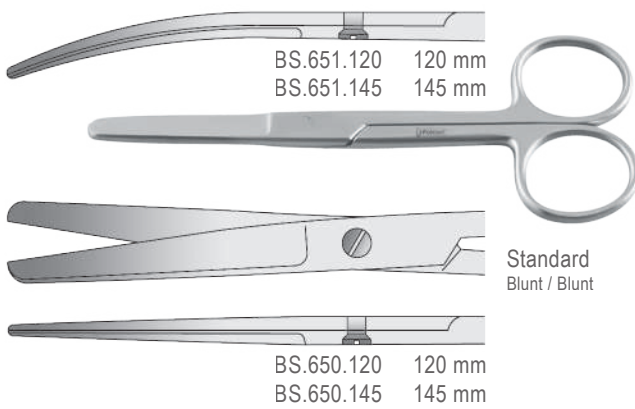
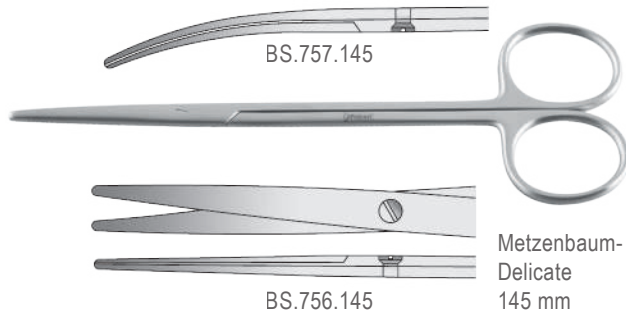

Operating Scissors

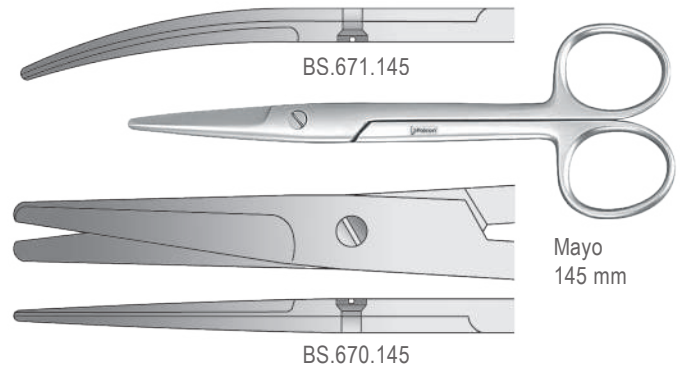

Suture Scissors

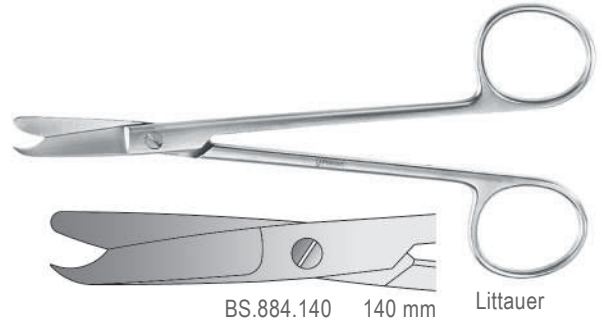
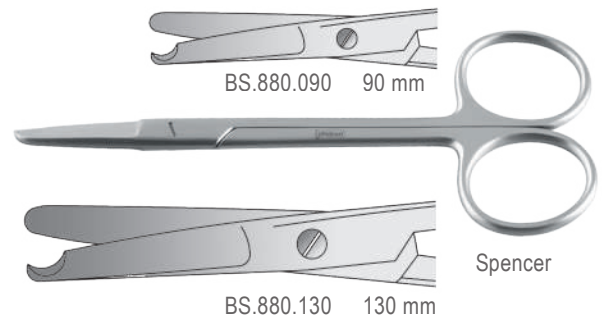

Bandage Scissors

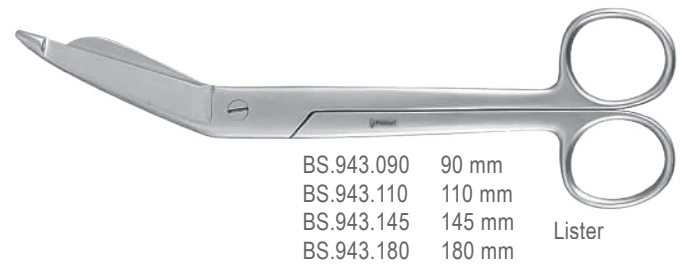

Surgery Instruments

Dissecting and Tissue Forceps



With Tungsten Carbide Inserts



BD.200.120
Adson
120 mm



BD.250.120
Adson
120 mm

Forceps Atraumatic



BD.318.160
DeBakey
160 mm



BD.319.160
DeBakey
160 mm

Dissecting Forceps



Iris

BD.350.100
100 mm

BD.351.100
100 mm

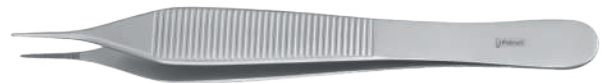

BD.360.120 120 mm
BD.360.150 150 mm
Adson-Micro



BD.370.120 120 mm
BD.370.150 150 mm
Adson



Semken

BD.394.125
125 mm

BD.395.125
125 mm

Dissecting Forceps



Gerald



BD.380.175
175 mm



BD.381.175
175 mm



Standard



- | | |
|------------|--------|
| BD.500.105 | 105 mm |
| BD.500.115 | 115 mm |
| BD.500.130 | 130 mm |
| BD.500.145 | 145 mm |
| BD.500.150 | 150 mm |
| BD.500.160 | 160 mm |
| BD.500.180 | 180 mm |
| BD.500.200 | 200 mm |
| BD.500.250 | 250 mm |
| BD.500.305 | 305 mm |

Tissue Forceps



Iris



BD.600.100
100 mm



BD.601.100
100 mm



Semken



BD.644.125
125 mm



BD.645.125
125 mm

Tissue Forceps

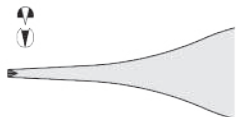

BD.610.120 120 mm
BD.610.150 150 mm
Adson-Micro

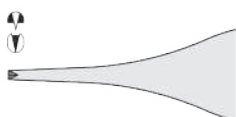

BD.620.120 120 mm
BD.620.150 150 mm
Adson



BD.626.120
Adson-Brown
120 mm

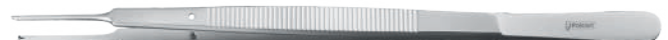

Gerald



BD.630.175
175 mm



BD.631.175
175 mm



Standard



- | | |
|------------|--------|
| BD.750.115 | 115 mm |
| BD.750.130 | 130 mm |
| BD.750.145 | 145 mm |
| BD.750.160 | 160 mm |
| BD.750.180 | 180 mm |
| BD.750.200 | 200 mm |

Surgery Instruments

Splinter Forceps

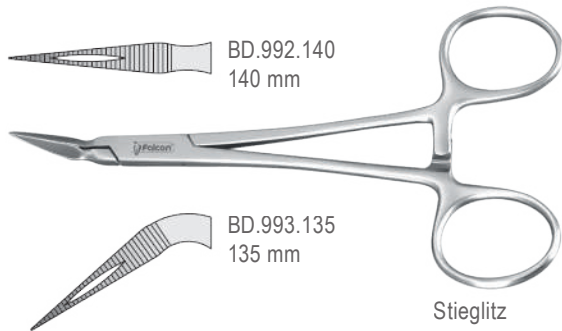

BD.992.140
140 mm

BD.993.135
135 mm

Stieglitz

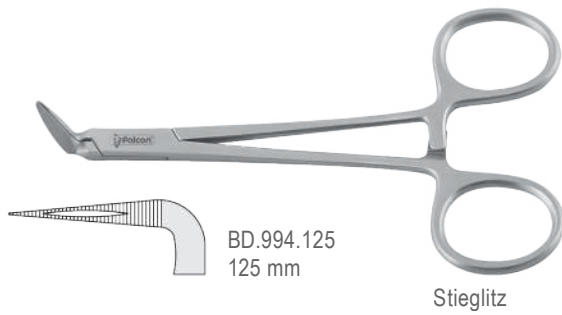

BD.994.125
125 mm

Stieglitz

Towel Forceps



BF.411.090
Schaedel
90 mm



BF.407.090
Jones
90 mm



BF.431.090 90 mm
BF.431.110 110 mm
BF.431.130 130 mm

Backhaus

Dressing and Sponge Forceps

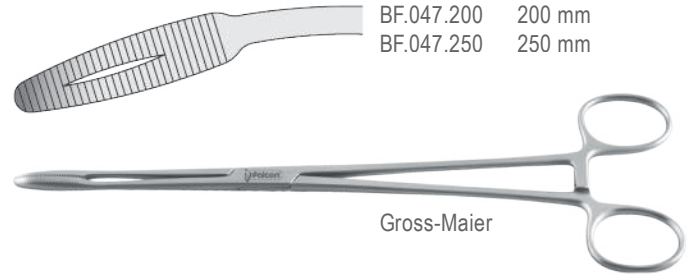

BF.047.200 200 mm
BF.047.250 250 mm

Gross-Maier



BF.046.200 200 mm
BF.046.250 250 mm

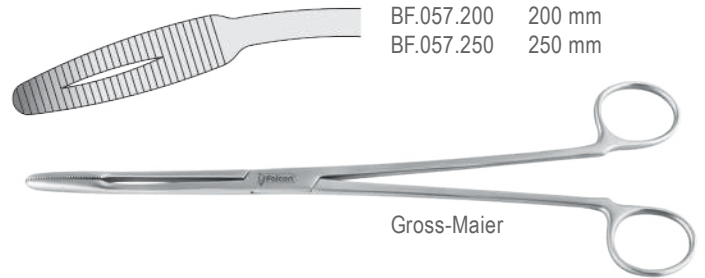

BF.057.200 200 mm
BF.057.250 250 mm

Gross-Maier



BF.056.200 200 mm
BF.056.250 250 mm

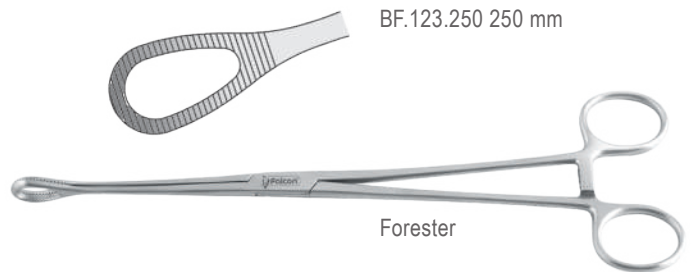

BF.123.250 250 mm

Forester



BF.122.250 250 mm

Haemostatic Forceps

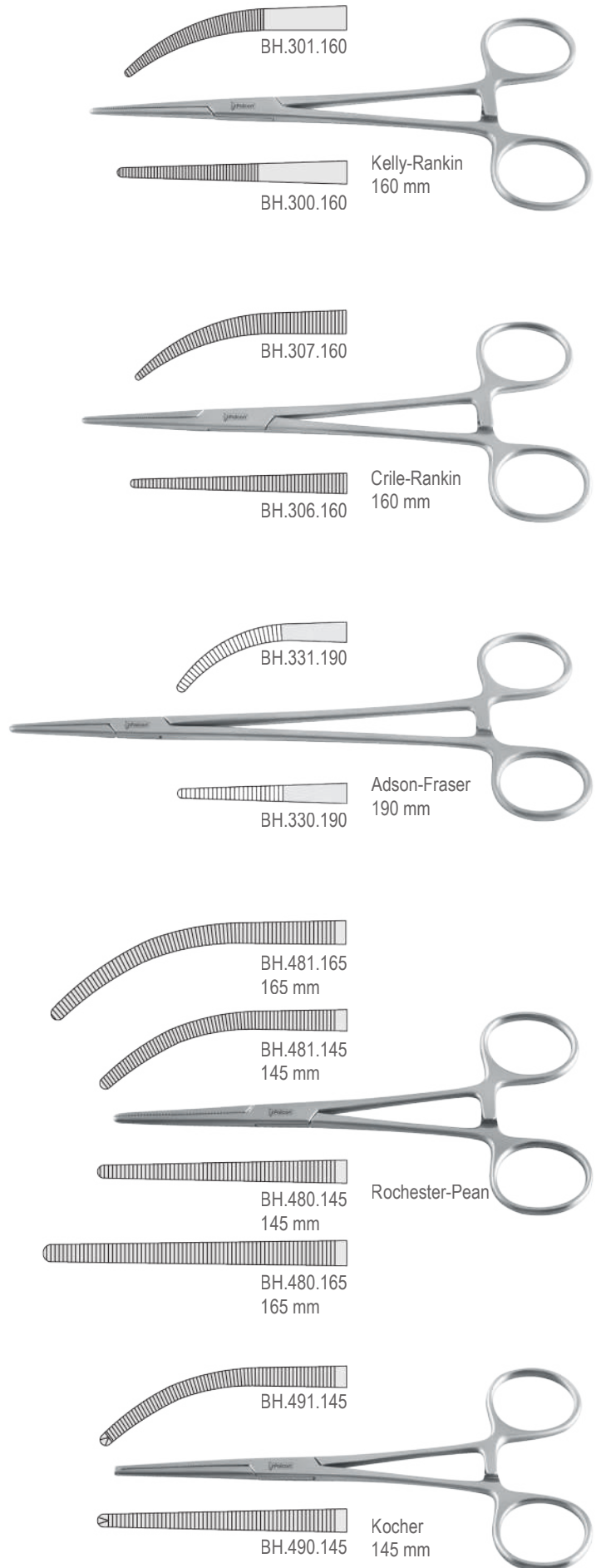
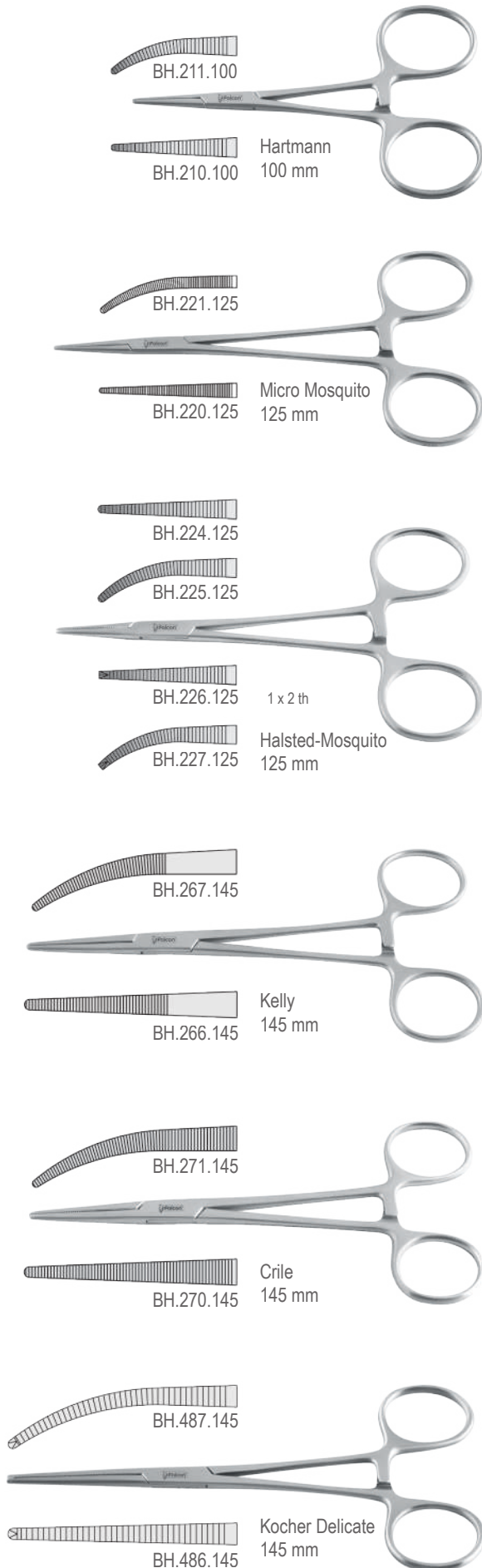

Surgery Instruments

Needle Holders **Falcon GRIP** With Tungsten Carbide Inserts



BN.151.140

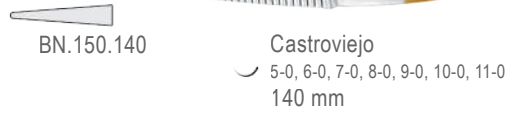

BN.150.140

Castroviejo
5-0, 6-0, 7-0, 8-0, 9-0, 10-0, 11-0
140 mm



BN.153.140

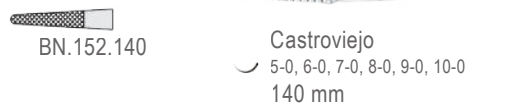

BN.152.140

Castroviejo
5-0, 6-0, 7-0, 8-0, 9-0, 10-0
140 mm



BN.155.140

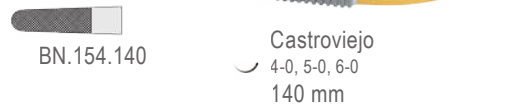

BN.154.140

Castroviejo
4-0, 5-0, 6-0
140 mm



BN.156.140

Castroviejo
5-0, 6-0, 7-0, 8-0, 9-0, 10-0, 11-0
140 mm



BN.157.140

Castroviejo
5-0, 6-0, 7-0, 8-0, 9-0, 10-0
140 mm



BN.158.140

Castroviejo
4-0, 5-0, 6-0
140 mm



BN.153.180

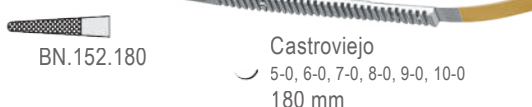

BN.152.180

Castroviejo
5-0, 6-0, 7-0, 8-0, 9-0, 10-0
180 mm

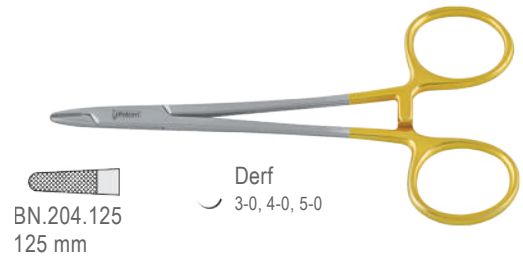

BN.204.125
125 mm

Derf
3-0, 4-0, 5-0



BN.200.130
130 mm

Halsey
3-0, 4-0, 5-0, 6-0

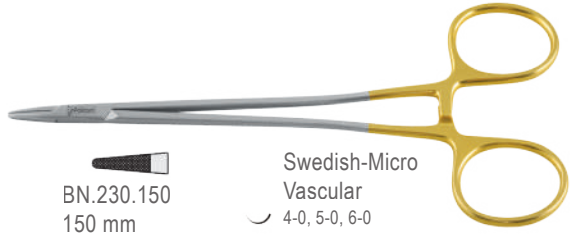

BN.230.150
150 mm

Swedish-Micro
Vascular
4-0, 5-0, 6-0

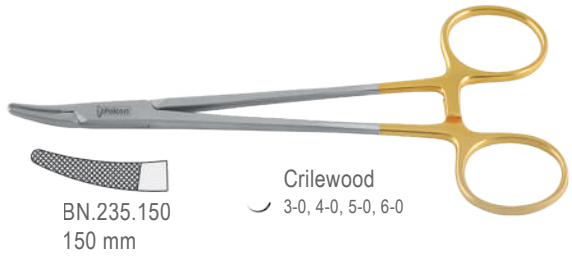

BN.235.150
150 mm

Crilewood
3-0, 4-0, 5-0, 6-0

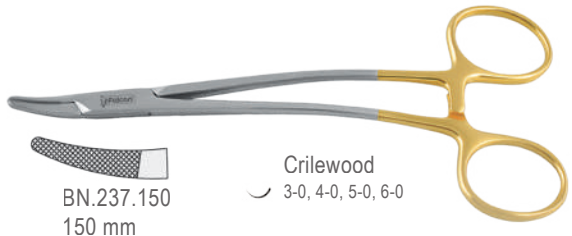

BN.237.150
150 mm

Crilewood
3-0, 4-0, 5-0, 6-0

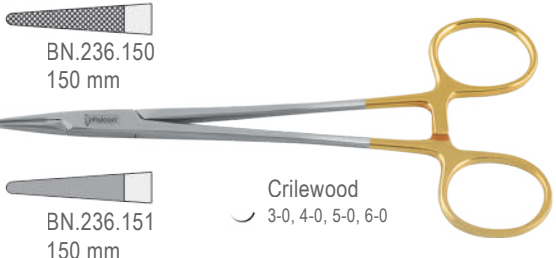

BN.236.150
150 mm

BN.236.151
150 mm

Crilewood
3-0, 4-0, 5-0, 6-0

Needle Holders **Falcon**[®] With Tungsten Carbide Inserts
GRIP

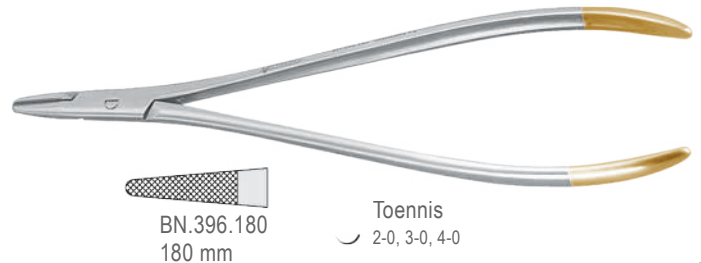
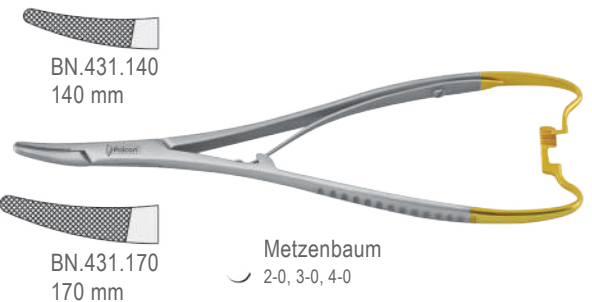
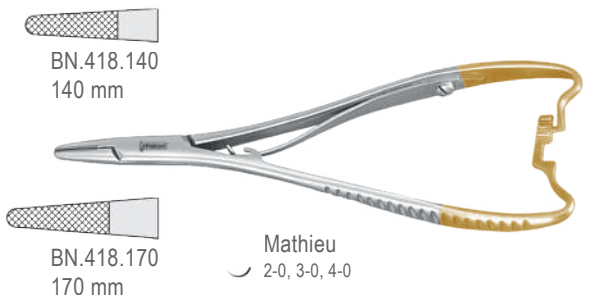
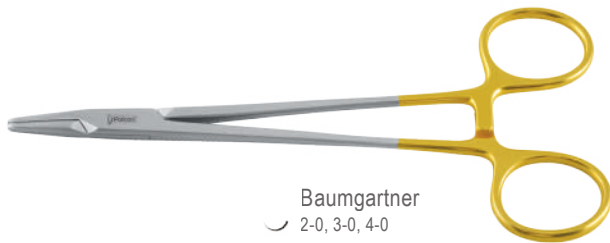
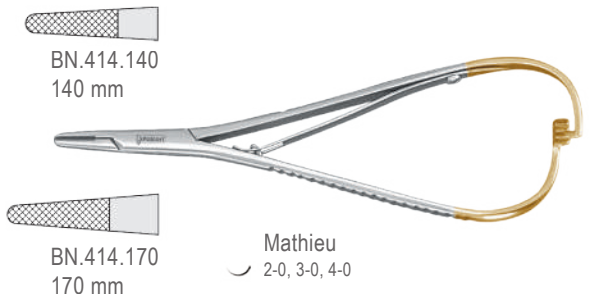
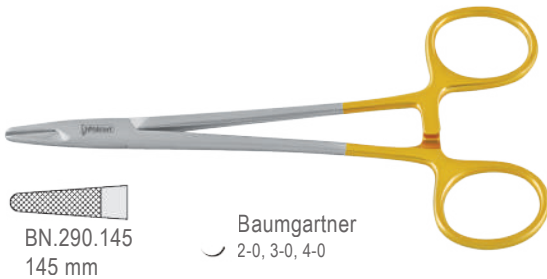
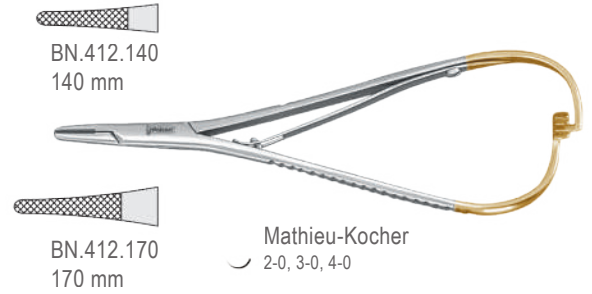

Surgery Instruments

Needle Holders



BN.453.140



BN.452.140

Castroviejo
5-0, 6-0, 7-0, 8-0, 9-0, 10-0
140 mm



BN.457.140

Castroviejo
5-0, 6-0, 7-0, 8-0, 9-0, 10-0
140 mm



BN.455.140



BN.454.140

Castroviejo
4-0, 5-0, 6-0
140 mm



BN.458.140

Castroviejo
4-0, 5-0, 6-0
140 mm



BN.464.130

Castroviejo
5-0, 6-0, 7-0, 8-0, 9-0, 10-0
130 mm



BN.506.125

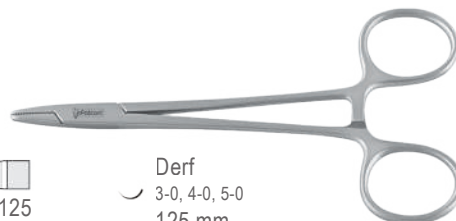

Derf
3-0, 4-0, 5-0
125 mm



BN.546.150

Crilewood
3-0, 4-0, 5-0, 6-0
150 mm



BN.580.145

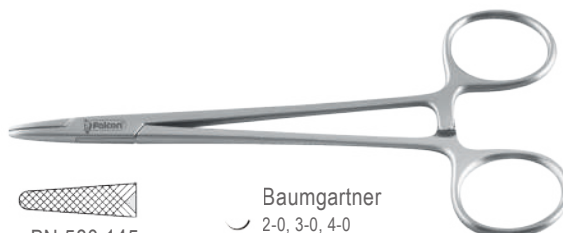

Baumgartner
2-0, 3-0, 4-0
145 mm



BN.596.140

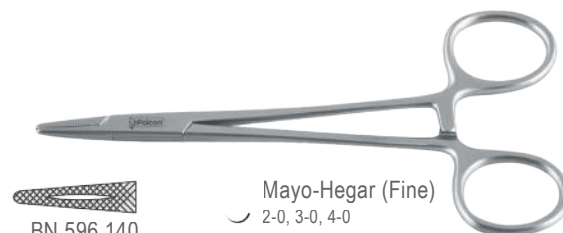

Mayo-Hegar (Fine)
2-0, 3-0, 4-0
140 mm



BN.597.140



Mayo-Hegar
2-0, 3-0, 4-0
140 mm

Needle Holders

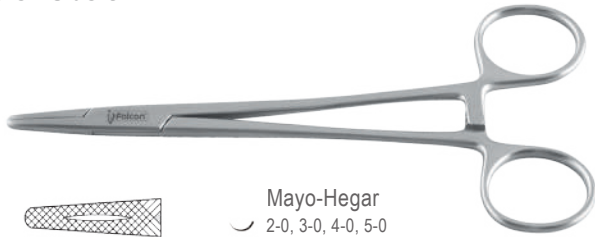

Mayo-Hegar
2-0, 3-0, 4-0, 5-0

BN.598.140
140 mm

BN.598.150
150 mm

BN.598.160
160 mm

BN.598.180
180 mm

BN.598.200
200 mm



Gillies
2-0, 3-0, 4-0, 5-0, 6-0

BL.539.160
Left handed

160 mm
With scissors

BN.689.160
Right handed



Olsen-Hegar
3-0, 4-0, 5-0

BN.674.140
140 mm

140 mm
With scissors



BN.700.120
120 mm

Boynton
4-0, 5-0, 6-0, 7-0, 8-0



BN.714.140
140 mm

Mathieu
2-0, 3-0, 4-0



BN.714.170
170 mm

Mathieu
2-0, 3-0, 4-0



BN.716.200
200 mm

Mathieu
2-0, 3-0, 4-0



BN.712.140
140 mm

Mathieu-Kocher
2-0, 3-0, 4-0



BN.712.170
170 mm

Mathieu-Kocher
2-0, 3-0, 4-0

Surgery Instruments

Skin Hooks



Kilner

BQ.045.150
150 mm



Gillies

BQ.041.010
180 mm



BQ.041.020
180 mm

Retractors

Sharp



Falcon
160 mm



BQ.103.010



BQ.103.020



BQ.103.030



BQ.103.040

Blunt



Falcon
160 mm



BQ.100.010



BQ.100.020

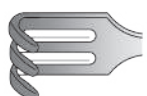

BQ.100.030



BQ.100.040

Retractors



Senn-Miller
160 mm

Blunt



BQ.150.160



Sharp



BQ.151.160



BQ.250.120
Farabeuf
120 mm
Pair



BQ.284.210
Parker-Langenbeck
210 mm
Pair

Retractors



Langenbeck
220 mm

- BQ.458.010 30 x 11 mm
- BQ.458.020 30 x 14 mm
- BQ.458.030 30 x 16 mm
- BQ.458.040 40 x 11 mm
- BQ.458.050 50 x 11 mm



Kocher-Langenbeck
215 mm

- BQ.468.050 40 x 11 mm
- BQ.468.060 50 x 11 mm



Kocher-Langenbeck
215 mm

- BQ.472.050 40 x 11 mm
- BQ.472.060 50 x 11 mm



Middeldorph

- BQ.680.010 14 x 17 mm, 215 mm
- BQ.680.020 20 x 22 mm, 220 mm
- BQ.680.030 26 x 30 mm, 235 mm

Self-Retaining Retractors



- | | | |
|------------|-------|-------|
| BR.040.070 | Blunt | Alm |
| BR.041.070 | Sharp | 70 mm |



- | | | |
|------------|-------|-----------|
| BR.074.135 | Blunt | Weitlaner |
| BR.077.135 | Sharp | 135 mm |

Probes

Ø 1.0 mm



BP.050.145
145 mm

Ø 2.0 mm



BP.055.145
145 mm

Suction Tubes

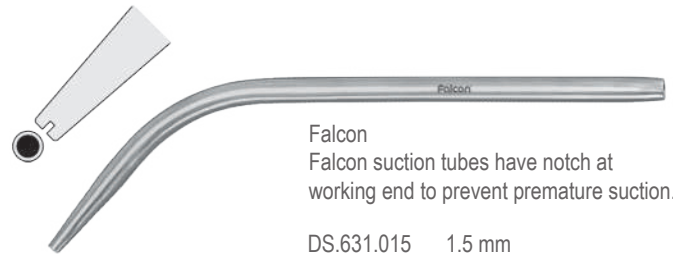

Falcon
Falcon suction tubes have notch at working end to prevent premature suction.

- DS.631.015 1.5 mm
- DS.631.030 3.0 mm
- DS.631.040 4.0 mm
- DS.631.050 5.0 mm



BT.201.100N 10FG / 3.3 mm
BT.201.120N 12FG / 4 mm
Frazier



Frazier
180 mm
BT.200.060 6 FG / 2.0 mm
BT.200.080 8 FG / 2.6 mm
BT.200.100 10 FG / 3.3 mm
BT.200.120 12 FG / 4.0 mm



DS.635.010 Small
DS.635.020 Large
Ladmore

Impression

Bite Gauge

A simple measuring instrument as an aid in the re-establishment of correct facial contour during full or partial denture work.

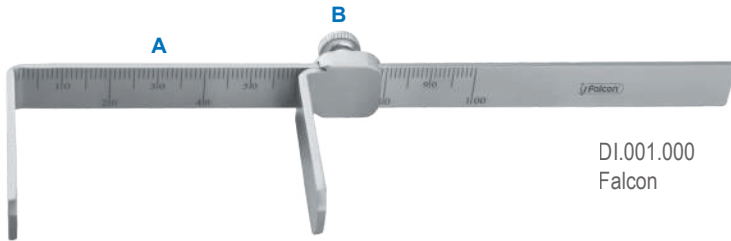

DI.001.000
Falcon

Slide **B** is fully adjustable and reversible along shaft **A** and may be fixed in any position by means of its locking-screw as shown.

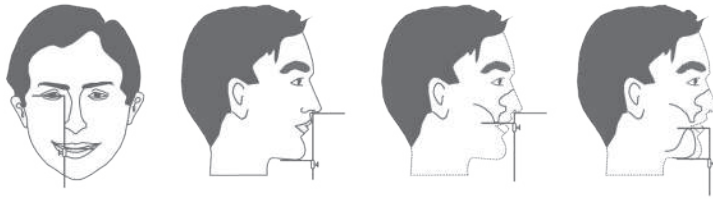

Bite Plane



DI.002.000
Fox

Gingival Cord Packers



DI.004.015
Fischer
Serrated



DI.004.025
Fischer
Serrated

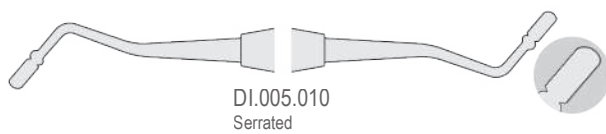

DI.005.010
Serrated

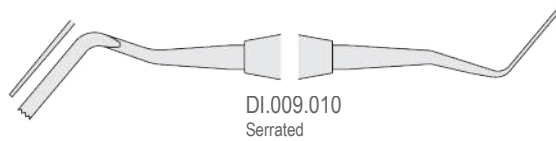

DI.009.010
Serrated

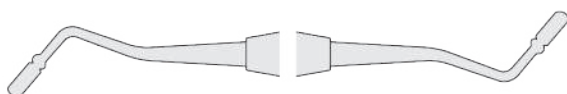

DI.005.020
Smooth

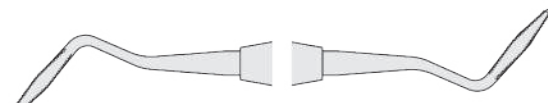

DI.006.020
Serrated

Carvers for Silicone Impression Materials



DI.010.017

Impression Trays

D-Color

Impression Trays Regular

- Color Coded for easy identification of size
- Micro etched inner surface for better retention
- Available perforated or solid



Perforated with Rim

Lower



Upper

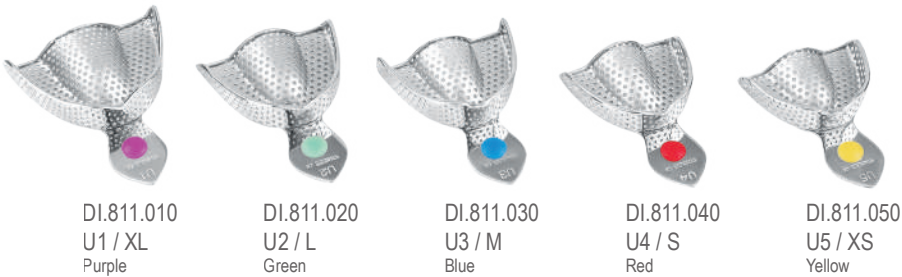

Solid with Rim

Lower

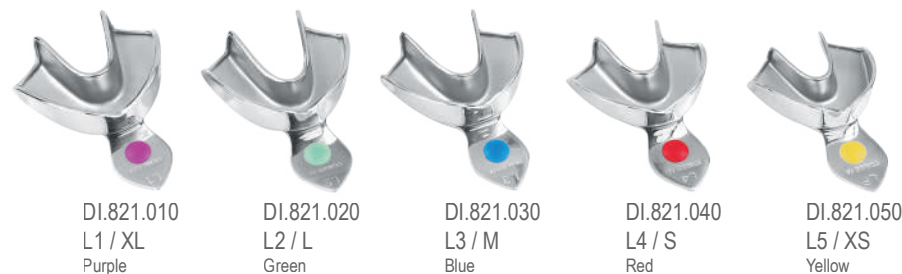

Upper

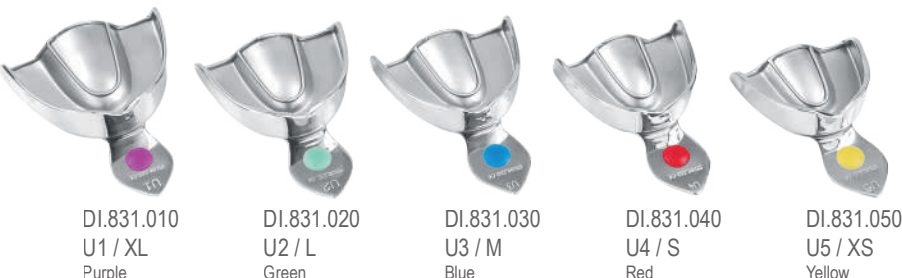

Impression

D-Color

Impression Trays Regular

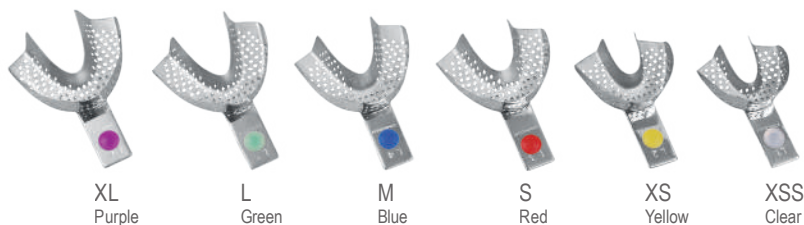

Perforated without Rim

Perforated with Rim

Lower

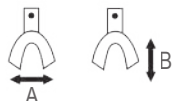

No.	Size	A mm	B mm	Code
L1	XXS	55	47	DI.701.010
L2	XS	60	49	DI.701.020
L3	S	72	54	DI.701.030
L4	M	74	57	DI.701.040
L5	L	76	59	DI.701.050
L6	XL	78	61	DI.701.060

Lower

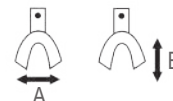

No.	Size	A mm	B mm	Code
L1	XXS	55	47	DI.751.010
L2	XS	60	49	DI.751.020
L3	S	72	54	DI.751.030
L4	M	74	57	DI.751.040
L5	L	76	59	DI.751.050
L6	XL	78	61	DI.751.060

Upper

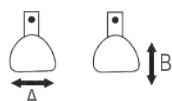

No.	Size	A mm	B mm	Code
U1	XXS	61	47	DI.706.010
U2	XS	64	51	DI.706.020
U3	S	66	53	DI.706.030
U4	M	69	57	DI.706.040
U5	L	71	60	DI.706.050
U6	XL	73	62	DI.706.060

Upper

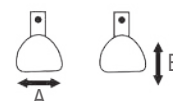

No.	Size	A mm	B mm	Code
U1	XXS	61	47	DI.756.010
U2	XS	64	51	DI.756.020
U3	S	66	53	DI.756.030
U4	M	69	57	DI.756.040
U5	L	71	60	DI.756.050
U6	XL	73	62	DI.756.060



Set	Contents	Code
6 pieces	L3,L4,L5,U3,U4,U5	DI.721.060
8 pieces	L3,L4,L5,L6,U3,U4,U5,U6	DI.721.080
12 pieces	L1,L2,L3,L4,L5,L6,U1,U2,U3,U4,U5,U6	DI.721.000

Set	Contents	Code
6 pieces	L3,L4,L5,U3,U4,U5	DI.771.060
8 pieces	L3,L4,L5,L6,U3,U4,U5,U6	DI.771.080
12 pieces	L1,L2,L3,L4,L5,L6,U1,U2,U3,U4,U5,U6	DI.771.000

Solid without Rim

Lower

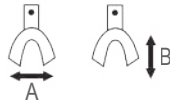

No.	Size	A mm	B mm	Code
L1	XXS	55	47	DI.711.010
L2	XS	60	49	DI.711.020
L3	S	72	54	DI.711.030
L4	M	74	57	DI.711.040
L5	L	76	59	DI.711.050
L6	XL	78	61	DI.711.060

Solid with Rim

Lower

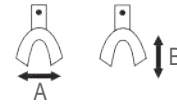

No.	Size	A mm	B mm	Code
L1	XXS	55	47	DI.761.010
L2	XS	60	49	DI.761.020
L3	S	72	54	DI.761.030
L4	M	74	57	DI.761.040
L5	L	76	59	DI.761.050
L6	XL	78	61	DI.761.060

Upper

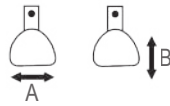

No.	Size	A mm	B mm	Code
U1	XXS	61	47	DI.716.010
U2	XS	64	51	DI.716.020
U3	S	66	53	DI.716.030
U4	M	69	57	DI.716.040
U5	L	71	60	DI.716.050
U6	XL	73	62	DI.716.060

Upper

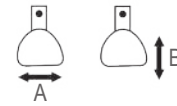

No.	Size	A mm	B mm	Code
U1	XXS	61	47	DI.766.010
U2	XS	64	51	DI.766.020
U3	S	66	53	DI.766.030
U4	M	69	57	DI.766.040
U5	L	71	60	DI.766.050
U6	XL	73	62	DI.766.060



Set	Contents	Code
6 pieces	L3,L4,L5,U3,U4,U5	DI.726.060
8 pieces	L3,L4,L5,L6,U3,U4,U5,U6	DI.726.080
12 pieces	L1,L2,L3,L4,L5,L6,U1,U2,U3,U4,U5,U6	DI.726.000



Set	Contents	Code
6 pieces	L3,L4,L5,U3,U4,U5	DI.781.060
8 pieces	L3,L4,L5,L6,U3,U4,U5,U6	DI.781.080
12 pieces	L1,L2,L3,L4,L5,L6,U1,U2,U3,U4,U5,U6	DI.781.000

D-Color

Silicone Buttons for Impression Trays

Fit any impression tray, easy identification of size.

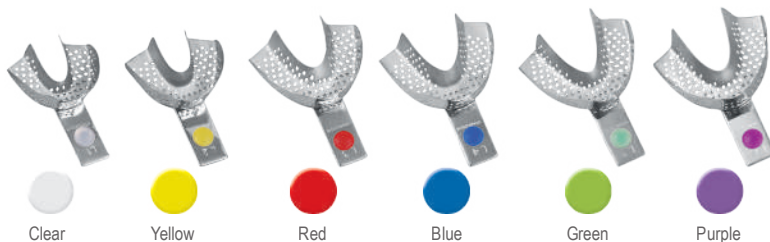

DI.999.000
Assorted pack of 24 buttons
6 colors, 4 of each color

Impression

Impression Trays Regular Perforated with Rim

Lower



No.	Size	A mm	B mm	Code
L1	XL	80	63	DI.800.010
L2	L	78	59	DI.800.020
L3	M	76	57	DI.800.030
L4	NM	72	57	DI.800.040
L5	S	69	50	DI.800.050

Upper

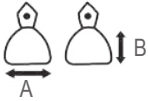

No.	Size	A mm	B mm	Code
U1	XL	81	63	DI.810.010
U2	L	74	60	DI.810.020
U3	M	71	55	DI.810.030
U4	NM	67	53	DI.810.040
U5	S	65	51	DI.810.050

Set	Contents	Code
6 pieces	L2,L3,L4,U2,U3,U4	DI.850.060
10 pieces	L1,L2,L3,L4,L5 U1,U2,U3,U4,U5	DI.850.000

Solid with Rim

Lower



No.	Size	A mm	B mm	Code
L1	XL	80	63	DI.820.010
L2	L	78	59	DI.820.020
L3	M	76	57	DI.820.030
L4	NM	72	57	DI.820.040
L5	S	69	50	DI.820.050

Upper

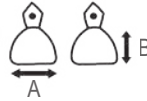

No.	Size	A mm	B mm	Code
U1	XL	81	63	DI.830.010
U2	L	74	60	DI.830.020
U3	M	71	55	DI.830.030
U4	NM	67	53	DI.830.040
U5	S	65	51	DI.830.050

Set	Contents	Code
6 pieces	L2,L3,L4,U2,U3,U4	DI.860.060
10 pieces	L1,L2,L3,L4,L5 U1,U2,U3,U4,U5	DI.860.000

Impression Trays for Children Perforated with Rim

Lower

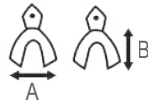

No.	Size	A mm	B mm	Code
L1	S	54	47	DI.200.010
L2	M	62	51	DI.200.020
L3	L	70	55	DI.200.030

Upper

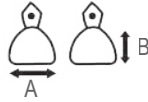

No.	Size	A mm	B mm	Code
U1	S	55	43	DI.210.010
U2	M	60	45	DI.210.020
U3	L	63	49	DI.210.030

Set	Contents	Code
6 pieces	L1,L2,L3,U1,U2,U3	DI.250.000

Solid with Rim

Lower

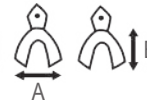

No.	Size	A mm	B mm	Code
L1	S	54	47	DI.220.010
L2	M	62	51	DI.220.020
L3	L	70	55	DI.220.030

Upper

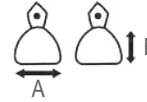

No.	Size	A mm	B mm	Code
U1	S	55	43	DI.230.010
U2	M	60	45	DI.230.020
U3	L	63	49	DI.230.030

Set	Contents	Code
6 pieces	L1,L2,L3,U1,U2,U3	DI.260.000

Impression Trays Regular Ehrlicke Pattern Perforated

Lower

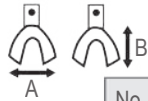

No.	Size	A mm	B mm	Code
UB0	XS	65	46	DI.600.000
UB1	S	67	50	DI.600.010
UB2	M	76	54	DI.600.020
UB3	L	79	56	DI.600.030
UB4	XL	79	61	DI.600.040

Upper

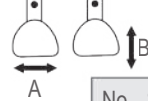

No.	Size	A mm	B mm	Code
OB0	XL	59	52	DI.610.000
OB1	L	66	52	DI.610.010
OB2	M	71	62	DI.610.020
OB3	NM	71	64	DI.610.030
oB4	S	80	70	DI.610.040

Set	Contents	Code
10 pieces	UB0,UB1,UB2,UB3,UB4 OB0,OB1,OB2,OB3,OB4	DI.640.000

Impression Trays Edentulous Perforated with Rim

Lower



No.	Size	A mm	B mm	Code
L1	XL	84	65	DI.300.010
L2	L	77	64	DI.300.020
L3	M	76	60	DI.300.030
L4	S	68	57	DI.300.040

Upper

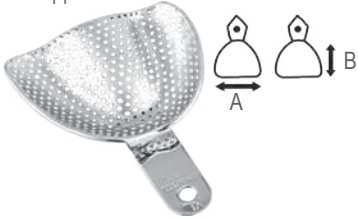

No.	Size	A mm	B mm	Code
U1	XL	80	62	DI.310.010
U2	L	77	60	DI.310.020
U3	M	70	60	DI.310.030
U4	S	72	56	DI.310.040

Set	Contents	Code
8 pieces	L1,L2,L3,L4, U1,U2,U3,U4	DI.350.000

Solid with Rim

Lower



No.	Size	A mm	B mm	Code
L1	XL	84	65	DI.320.010
L2	L	77	64	DI.320.020
L3	M	76	60	DI.320.030
L4	S	68	57	DI.320.040

Upper



No.	Size	A mm	B mm	Code
U1	XL	80	62	DI.330.010
U2	L	77	60	DI.330.020
U3	M	70	60	DI.330.030
U4	S	72	56	DI.330.040

Set	Contents	Code
8 pieces	L1,L2,L3,L4, U1,U2,U3,U4	DI.360.000

Impression Trays Anterior Depressed Perforated with Rim

Lower

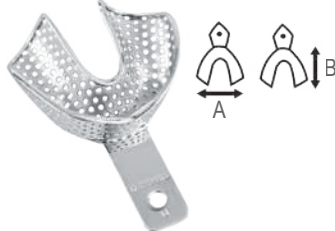

No.	Size	A mm	B mm	Code
L1	S	65	48	DI.500.010
L2	M	72	57	DI.500.020
L3	L	75	57	DI.500.030

Upper



No.	Size	A mm	B mm	Code
U1	S	64	56	DI.510.010
U2	M	67	60	DI.510.020
U3	L	72	63	DI.510.030

Set	Contents	Code
6 pieces	L1,L2,L3,U1,U2,U3	DI.550.000

Solid with Rim

Lower



No.	Size	A mm	B mm	Code
L1	S	65	48	DI.520.010
L2	M	72	57	DI.520.020
L3	L	75	57	DI.520.030

Upper



No.	Size	A mm	B mm	Code
U1	S	64	56	DI.530.010
U2	M	67	60	DI.530.020
U3	L	72	63	DI.530.030

Set	Contents	Code
6 pieces	L1,L2,L3,U1,U2,U3	DI.560.000

Impression Trays Edentulous Ehrlicke Pattern Perforated

Lower

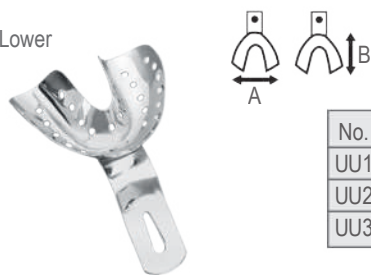

No.	Size	A mm	B mm	Code
UU1	S	70	48	DI.400.010
UU2	M	70	53	DI.400.020
UU3	L	72	57	DI.400.030

Upper

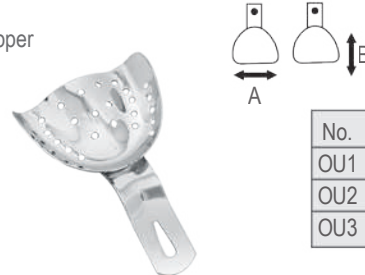

No.	Size	A mm	B mm	Code
OU1	S	64	46	DI.410.010
OU2	M	68	53	DI.410.020
OU3	L	79	61	DI.410.030

Set	Contents	Code
6 pieces	UU1,UU2,UU3, OU1,OU2,OU3	DI.450.000

Impression

Partial Impression Trays for Crown and Bridge Work Perforated with Rim



DI.900.300
Fig. 30
Upper left / Lower right



DI.900.310
Fig. 31
Lower left / Upper right



DI.900.320
Fig. 32
Lower jaw



DI.900.330
Fig. 33
Upper jaw



DI.900.990
Fig. 99
Lateral

Solid with Rim



DI.905.300
Fig. 30
Upper left / Lower right



DI.905.310
Fig. 31
Lower left / Upper right



DI.905.320
Fig. 32
Lower jaw



DI.905.330
Fig. 33
Upper jaw



DI.905.990
Fig. 99
Lateral

Perforated without Rim

Lower left / Upper right



No.	Size	Code
Fig. L2D	S	DI.899.040
Fig. L4D	M	DI.899.050
Fig. L6D	L	DI.899.060

Upper left / Lower right



No.	Size	Code
Fig. L2S	S	DI.899.010
Fig. L4S	M	DI.899.020
Fig. L6S	L	DI.899.030

Perforated with Rim

Lower left / Upper right



No.	Size	Code
Fig. L2D	S	DI.901.040
Fig. L4D	M	DI.901.050
Fig. L6D	L	DI.901.060

Upper left / Lower right



No.	Size	Code
Fig. L2S	S	DI.901.010
Fig. L4S	M	DI.901.020
Fig. L6S	L	DI.901.030

Articulators



DL.050.000
Falcon Deluxe
Contents:
1 x Articulator unit
1 x Occlusion plate
6 x Mounting plates (DL.050.001)
1 x Adjustable back rod



DL.051.000
Falcon Deluxe
Contents:
1 x Articulator unit
6 x Mounting plates (DL.050.001)



DL.041.000
Falcon
Contents:
1 x Articulator unit
2 x Mounting plates (DL.050.001)

Accessories



Mounting plates
DL.050.001
Pack of 10 pieces



Complete magnetic plate
DL.050.002



Cast fastening washers
DL.050.003
Pack of 10 pieces



Magnet
DL.050.004

Articulators

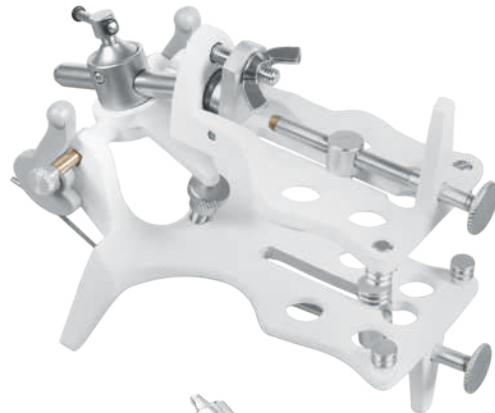

Plasterless articulator
DL.060.000



Fig. 50
DL.025.050
Full arch

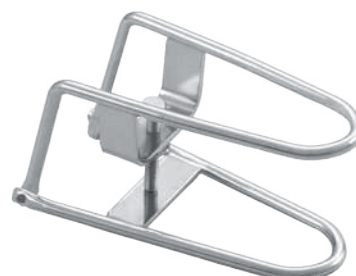

Fig. 51
DL.025.051
Full denture



Fig. 57
DL.025.057
Crown & bridge

Occlusor



DL.027.000

Laboratory

Calipers

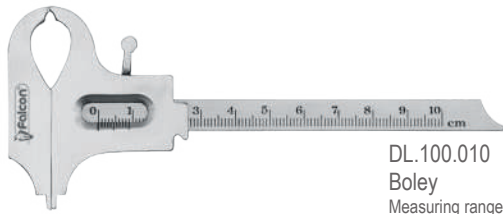

DL.100.010
Boley
Measuring range
0 - 100 mm



Iwanson
for metal
Measuring range
0-10 mm

DL.101.030
Deluxe model
with black colored markings

DL.101.010
Standard model
with steel stamp markings

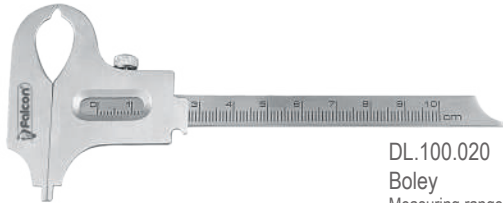

DL.100.020
Boley
Measuring range
0 - 100 mm



Iwanson
for wax
Measuring range
0-10 mm

DL.101.040
Deluxe model
with black colored markings

DL.101.020
Standard model
with steel stamp markings

Crown Grippers



DL.151.125 125 mm
DL.151.150 150 mm



DL.154.020
125 mm

Crown Scissors



Bee Bee
BS.912.110
110 mm

Crown Scissors



Pedo
BS.915.095
95 mm

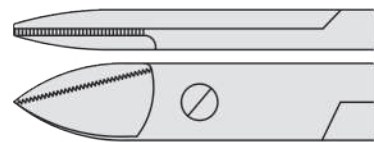

BS.920.110

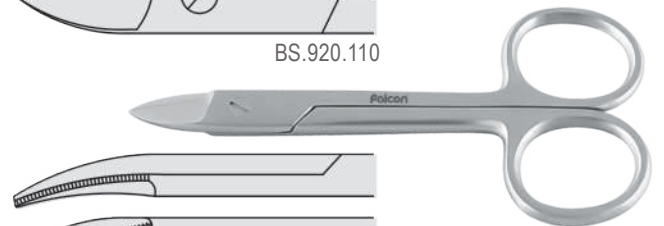

Bee Bee
110 mm

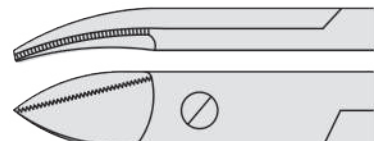

BS.921.110

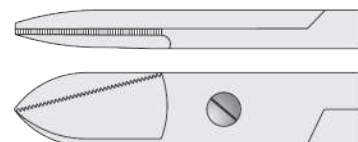

BS.920.120

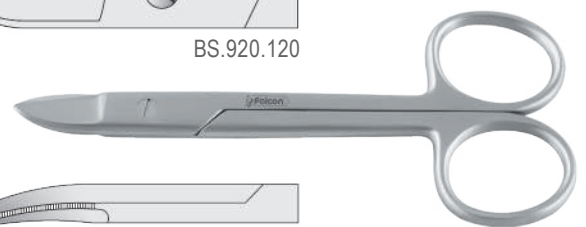

Bee Bee
120 mm

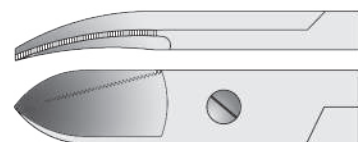

BS.921.120

Plaster Cutters



DL.325.200
Straight
200 mm

DL.326.200
Curved
200 mm

Furnace Tongs and Tweezers



DL.790.200
200 mm

DL.790.300
300mm



DL.700.310
310 mm



DL.705.400
400 mm



DL.715.560
560 mm

Fret Saw



DL.650.000

Modeling Saw



DL.655.000

Soldering Tweezers



DL.780.010
160 mm



DL.780.020
160 mm

Riveting Mallets



Fig. 1
DL.255.010
220 mm



Fig. 2
DL.255.020
220 mm

Laboratory

Spatulae Rigid



Fig. 1
DL.400.010
Falcon
185 mm



Fig. 2
DL.400.020
Falcon
180 mm



DL.410.170
Lichtenstein
170 mm



DL.415.200
Roghe
200 mm



Fig. 8
DL.450.080
Falcon
210 mm



Fig. 9
DL.450.090
Falcon
230 mm

Spatulae Flexible



Fig. 3
DL.450.030
Falcon
190 mm



Fig. 4
DL.450.040
Falcon
200 mm



Fig. 5
DL.450.050
Falcon
215 mm



Fig. 6
DL.450.060
Falcon
210 mm



Fig. 7
DL.450.070
Falcon
210 mm

Flexible Plastic Spatulae



	Blue Dark	DL.461.010
	Green	DL.461.020
	Orange	DL.461.030
	Pink	DL.461.040
	Red	DL.461.050
	White	DL.461.060
	Yellow	DL.461.070



DL.460.010
Falcon
Super flexible plastic
190 mm

Bowls for Plaster and Alginate



Ø100 mm
DL.500.010



Ø120 mm
DL.500.020

Alcohol Lamp Deluxe



DL.015.010
Small
DL.015.020
Large

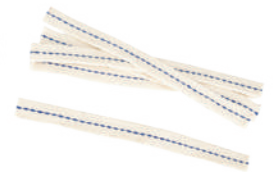

DL.019.020
Spare wicks (pack of 5)

Alcohol Lamp Standard



DL.010.000



DL.019.010
Spare wicks (pack of 5)

Plaster Knives with Bakelite Handle, Autoclavable



Fig. 1

DL.332.010
Falcon
180 mm



Fig. 1

DL.337.160
Gritman
160 mm



Fig. 2

DL.337.170
Gritman
170 mm

Plaster Knives with Wooden Handle



Fig. 1

DL.330.010
Falcon
180 mm



DL.335.160
Gritman
160 mm



DL.335.170
Gritman
170 mm



DL.340.180
Sacks
180 mm



Fig. 1

DL.350.010
Falcon
170 mm



Fig. 3

DL.350.030
Falcon
160 mm



Fig. 4

DL.350.040
Falcon
160 mm



Fig. 5

DL.350.050
Falcon
135 mm



Fig. 6

DL.350.060
Falcon
135 mm

Wax Knives with Bakelite Handle, Autoclavable



DL.815.070 Fahnenstock 130 mm



DL.815.080 Fahnenstock 175 mm



DL.825.070 Lessmann 130 mm



DL.825.080 Lessmann 175 mm

Wax Knives with Metal Handle, Autoclavable



DL.815.030 Fahnenstock 130 mm



DL.815.040 Fahnenstock 175 mm



DL.825.030 Lessmann 130 mm



DL.825.040 Lessmann 175 mm

Wax Knives Ermert



DL.810.010 Wooden handle



DL.810.030 Plastic handle



DL.810.020 Metal handle

Wax Knives with Plastic Handle, Non-autoclavable



	Fahnenstock	Fahnenstock
	130 mm	175 mm
	DL.815.050	DL.815.060
	DL.815.051	DL.815.061
	DL.815.052	DL.815.062
	DL.815.053	DL.815.063
	DL.815.054	DL.815.064
	DL.815.055	DL.815.065



	Lessmann	Lessmann
	130 mm	175 mm
	DL.825.050	DL.825.060
	DL.825.051	DL.825.061
	DL.825.052	DL.825.062
	DL.825.053	DL.825.063
	DL.825.054	DL.825.064
	DL.825.055	DL.825.065

Wax Knives with Wooden Handle



DL.805.010 con scodellino 130 mm



DL.805.020 con scodellino 175 mm



DL.815.010 Fahnenstock 130 mm



DL.815.020 Fahnenstock 175 mm



DL.825.010 Lessmann 130 mm



DL.825.020 Lessmann 175 mm

Ceramic Sculpturing Instruments



Fig. 1
DL.950.010



Fig. 2
DL.950.020



Fig. 3
DL.950.030
Knife



DL.950.000
Set of 3



Fig. 1
DL.955.010



Fig. 2
DL.955.020



Fig. 3
DL.955.030
Knife



DL.955.000
Set of 3

Flexible



Fig. 1 DL.949.010



Fig. 3 DL.949.030
Knife



Fig. 2 DL.949.020

Super flexible



Fig. 1 DL.949.011



Fig. 3 DL.949.031
Knife



Fig. 2 DL.949.021

Modeling Carvers
P.K. Thomas



Fig. 1 DL.905.010



Fig. 2 DL.905.020



Fig. 5 DL.905.050

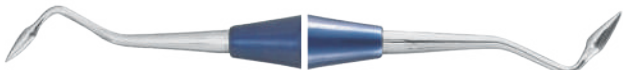
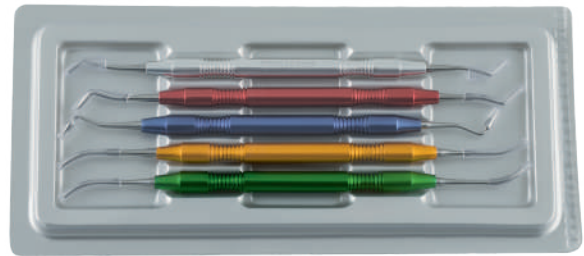

Fig. 3 DL.905.030



DL.905.000
Set of 5



Fig. 4 DL.905.040

P.K. Thomas



Fig. 1 DL.900.010



Fig. 2 DL.900.020



Fig. 5 DL.900.050



Fig. 3 DL.900.030



DL.900.000
Set of 5



Fig. 4 DL.900.040



Fig. 1 DL.932.010 Vehe



Fig. 31 DL.870.310 Gritman



Fig. 13 DL.864.130 Falcon



Fig. 1 DL.855.010 Beale



Fig. 12 DL.864.120 Falcon



Fig. 1 DL.918.010 Roach

Modeling Carvers



Fig. 1	Fig. 2	Fig. 3	Fig. 4	Fig. 5	Fig. 6	Fig. 7	Fig. 1	Fig. 2	Fig. 3	Fig. 4	Fig. 5	Fig. 6
DL.864.010	DL.864.020	DL.864.030	DL.864.040	DL.864.050	DL.864.060	DL.864.070	DL.945.010	DL.945.020	DL.945.030	DL.945.040	DL.945.050	DL.945.060
Falcon	Falcon	Falcon	Falcon	Falcon	Falcon	Falcon	Zahle	Zahle	Zahle	Zahle	Zahle	Zahle
130 mm	140 mm	140 mm	135 mm	140 mm	117 mm	115 mm	120 mm	125 mm	125 mm	120 mm	120 mm	115 mm

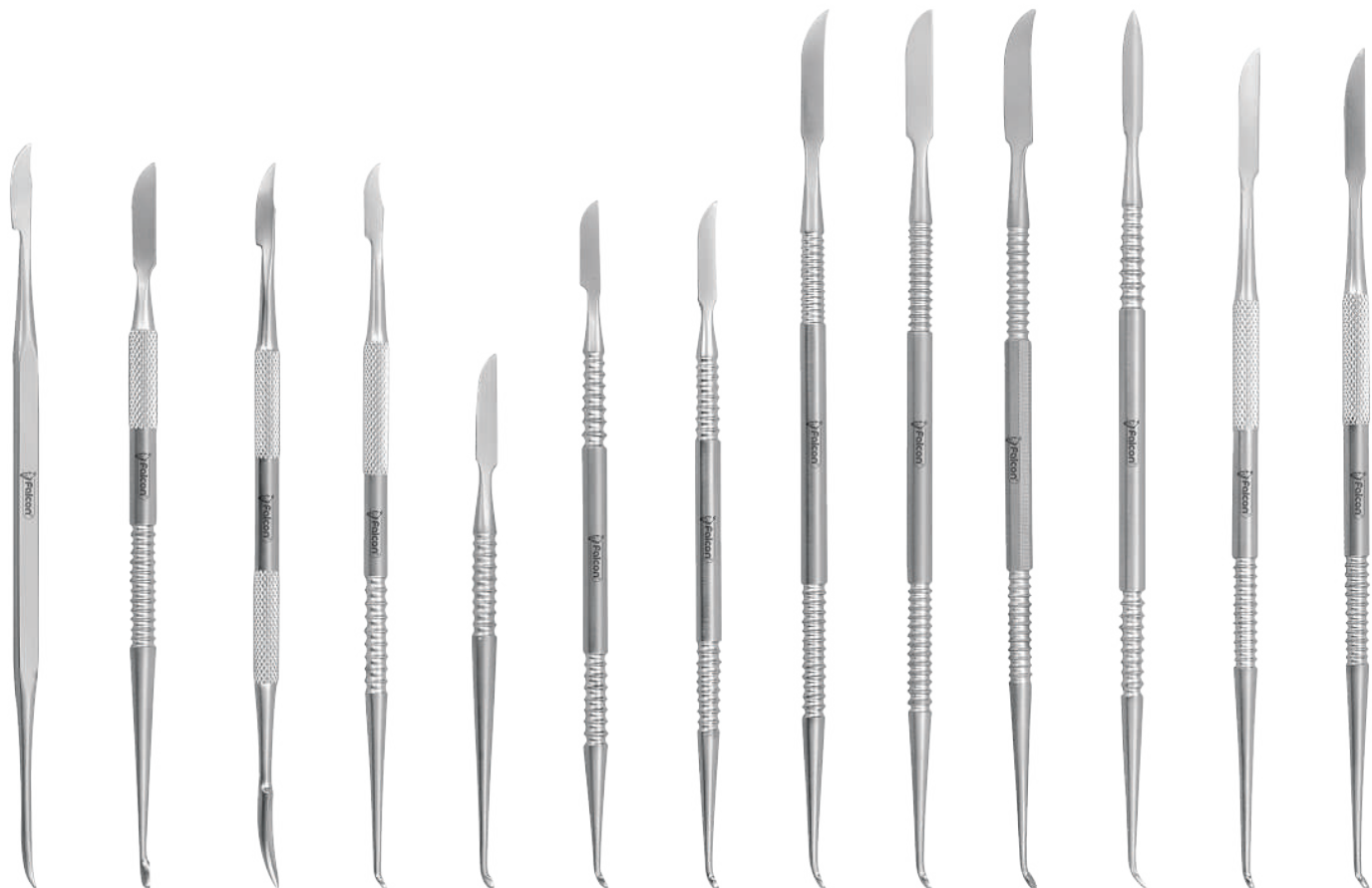
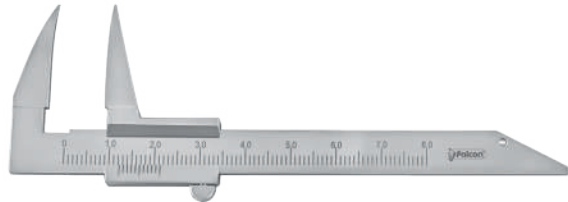
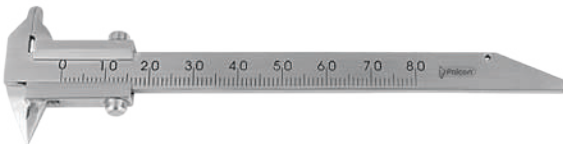

Fig. 1	Fig. 3	Fig. 5	Fig. 6	Fig. 1	Fig. 2	Fig. 3	Fig. 1	Fig. 2	Fig. 3	Fig. 4	Fig. 7	Fig. 8
DL.875.010	DL.875.030	DL.875.050	DL.875.060	DL.882.010	DL.882.020	DL.882.030	DL.880.010	DL.880.020	DL.880.030	DL.880.040	DL.880.070	DL.880.080
Hylin	Hylin-Ceramica	Hylin-Falcon	Hylin-Lecron	Lecron-Mini	Lecron-Mini	Lecron-Mini	Lecron	Lecron	Lecron	Lecron	Lecron	Lecron
135 mm	135 mm	135 mm	135 mm	100 mm	130 mm	130 mm	165 mm	165 mm	165 mm	165 mm	160 mm	160 mm

Measuring instruments



DO.170.000
Beerendonk
Dental vernier with long and fine tips for intraoral measurements



DO.172.000
Falcon
Double sided, for inner and outer measurements



DO.160.000
Bernklau
Orthodontic ruler, Perfect for all diagnostic measurements, both intraoral and on the model



BA.225.150 150 mm / 6"
BA.225.300 300 mm / 12"
Ruler stainless steel



DO.151.000
Falcon
Bow divider, to measure tooth width, bracket distance to the incisal edge etc.



DO.175.000
Orthodontic bow compass

Bracket Positioning Gauge



Bracket positioning gauge
Facilitate bracket positioning to exact desired distance by measuring its height, from slot to incisal / occlusal surface of tooth



DO.200.010
Boone

Universal for both .018" or .022" slot brackets
Four different heights for bracket positioning:
3.5, 4, 4.5, & 5 mm
Stainless Steel, autoclavable



Falcon bracket positioning gauges
Four different heights for bracket positioning: 3.5, 4, 4.5, & 5 mm
Two different models for .018" or .022" slot brackets



DO.205.018 For .018" slot brackets
DO.205.022 For .022" slot brackets
Anodized aluminum, autoclavable



DO.206.018 For .018" slot brackets
DO.206.022 For .022" slot brackets



DO.204.000

Orthodontic

Instruments for D.B. Brackets Bracket Placing Tweezers



SDV69
150 mm



DO.210.135
135 mm



DO.217.135
135 mm



DO.220.110
110 mm

Bracket Tweezers with Slot Aligner



DO.213.135
Fig. 1
135 mm



DO.214.135
Fig. 2
135 mm



DO.215.135
Fig. 3
135 mm



Bracket placer for posterior teeth
Very helpful instrument for placing D.B.brackets from bicuspids to molars, the small head offers excellent view



DO.209.010

Instruments for D.B. Brackets



Band pusher with serrated rectangular tip for good transfer of force when positioning bands.



DO.120.010
Mershon



Band seating instrument with hard metal triangular serrated tip, autoclavable 121° C



DO.125.010
Falcon



DO.227.120 120 mm
DO.227.135 135 mm
Keat
Buccal tube tweezers



DO.228.120 120 mm
DO.228.135 135 mm
Falcon
Reverse action buccal tube tweezers

Scaler and Band Pushing Instruments

Sharp scaling tip on one end and serrated band pusher on the other



DO.130.010



DO.130.015

Adhesive Removers

Sharp scaling tip on one end and serrated band pusher on the other



DO.235.010



DO.235.015

Distal End Bending Instruments



Distal end bending instruments

Very useful instrument for bending archwire distal ends to the buccal tube to create an easy cinch back bend in an area which is usually very hard to reach. Simply insert instrument to distal end of wire extracting through buccal tube and twist forward. Also can be used to bend tails of springs



DO.240.010
For wire upto .022" (0.56 mm)

DO.240.020
For wire upto .030" (0.76 mm)



DO.240.015
For wire upto .022" (0.56 mm)

DO.240.025
For wire upto .030" (0.76 mm)



DO.240.035
For wires .022" (0.56 mm) and .030" (0.76 mm)

Elastic Ligature Applicators

For easy placement of elastic ligatures under bracket tie wings.



DO.250.010



DO.377.015
Elastic ligature applicator



Elastomeric Ligature Removing Instruments



DD.155.160
Fig. 23/16

Ligature Tuckers

Used to tuck metal ligatures, also useful for inserting arch wires into bracket slots and applying elastic chains. Straight end is for anterior use and angled of posterior.



DO.375.010



DO.376.010



DO.377.010



DO.370.015



DO.370.025



DO.377.015

Separators Placing Pliers

For easy placement of radiopaque and non-radiopaque separators.

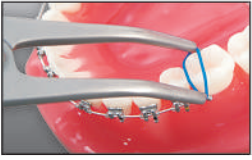

DO.270.160
160 mm

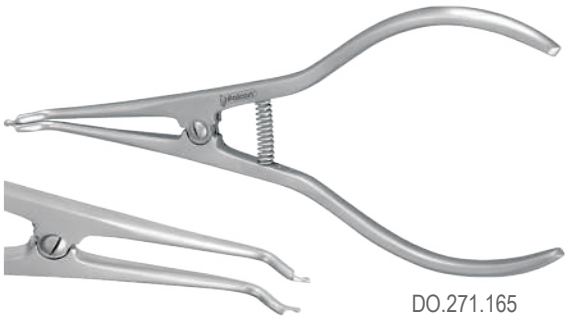

DO.271.165
165 mm

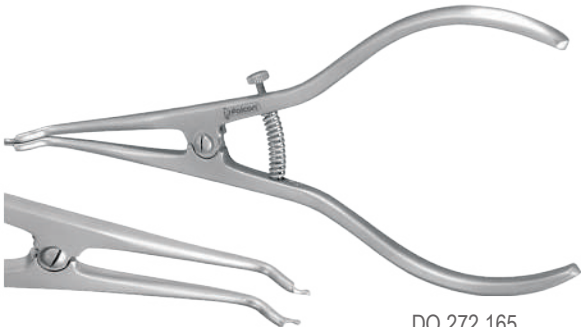

DO.272.165
165 mm



DO.270.155
155 mm

Elastomeric Ligature Removing Tweezers

For easy removal of elastomeric ligatures.



DO.285.010

Elastics Ligature Placing Forceps with Groove

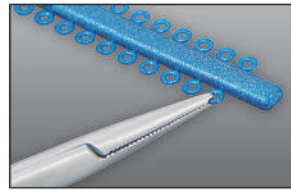

Excellent for placing elastic ligatures, grooved tip provides non-slip grip of any type of elastomeric.



DO.292.120
Falcon
120 mm



DO.295.140
Falcon
140 mm

Elastic Ligature Placing Forceps

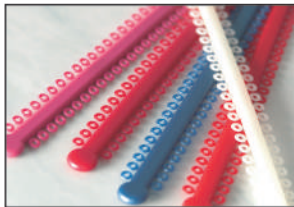

Elastic ligature placing forceps with hook
Excellent for placing elastic ligatures, hook on tip provides non-slip grip of any type of elastomeric.

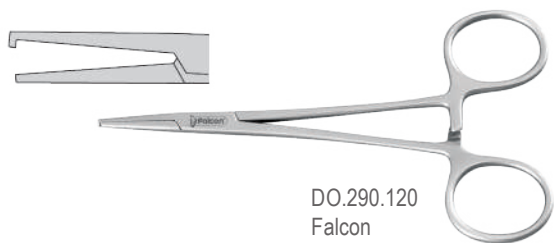

DO.290.120
Falcon
120 mm
Straight

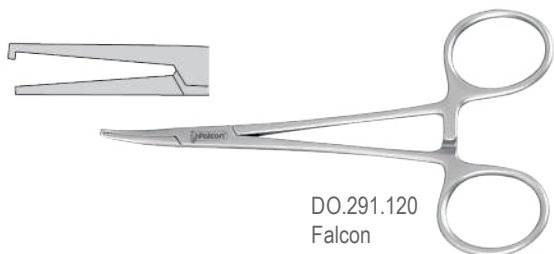

DO.291.120
Falcon
120 mm
Curved



DO.294.140
Falcon
140 mm

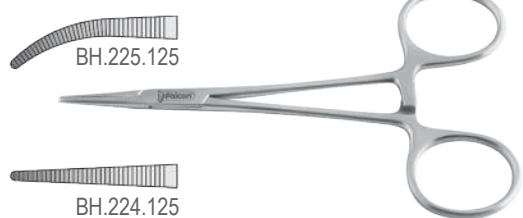

BH.225.125

BH.224.125

Halsted-Mosquito
125 mm

Ligature Pliers

Falcon offers wide variety of pliers for ligatures wires with or without tungsten carbide inserts.

Falcon and Smaha pattern pliers have finer tips than standard Mathieu patterns, these are also suitable for placing elastic ligatures.



With Tungsten Carbide Inserts



DO.393.030
Falcon
140 mm



DO.392.010

Falcon
140 mm



DO.392.020



DO.392.030



DO.396.140



DO.395.140

Smaha
140 mm



Pliers for "Fixed Appliance Technique"

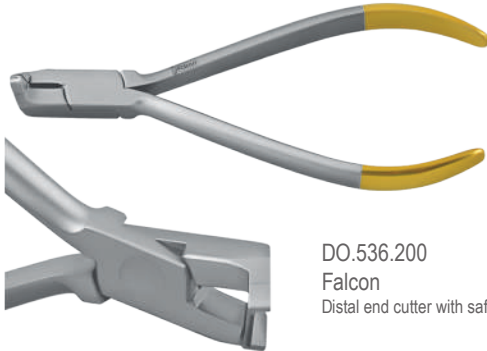

DO.536.200
Falcon
Distal end cutter with safety hold

- Max. 0.30 mm to 0.50 mm (.012" to .020")
- Max. 0.46 mm x 0.64 mm (.018" x .025")
- ⊗ Max. 0.38 mm to 0.53 mm (.0155" to .0215")
- ⊗ Max. 0.53 mm x 0.64 mm (.021" x .025")

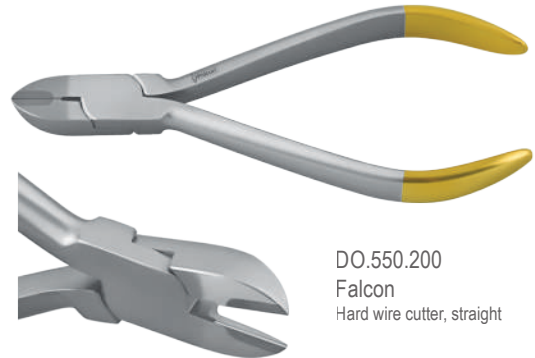

DO.550.200
Falcon
Hard wire cutter, straight

- Max. 0.30 mm to 0.50 mm (.012" to .020")
- Max. 0.56 mm x 0.71 mm (.022" x .028")

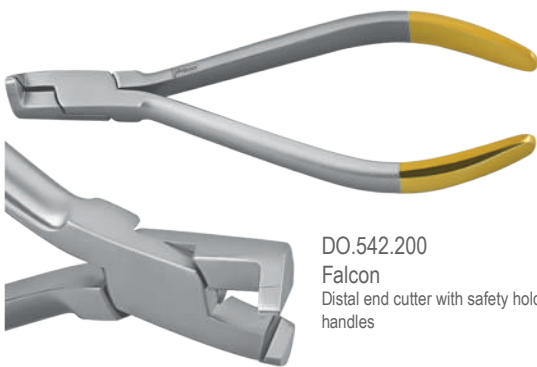

DO.542.200
Falcon
Distal end cutter with safety hold, long handles

- Max. 0.30 mm to 0.50 mm (.012" to .020")
- Max. 0.46 mm x 0.64 mm (.018" x .025")
- ⊗ Max. 0.38 mm to 0.53 mm (.0155" to .0215")
- ⊗ Max. 0.53 mm x 0.64 mm (.021" x .025")

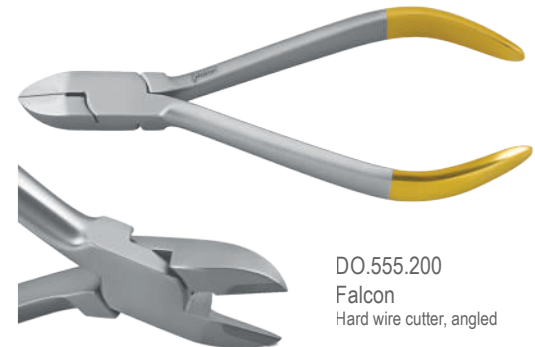

DO.555.200
Falcon
Hard wire cutter, angled

- Max. 0.30 mm to 0.50 mm (.012" to .020")
- Max. 0.56 mm x 0.71 mm (.022" x .028")

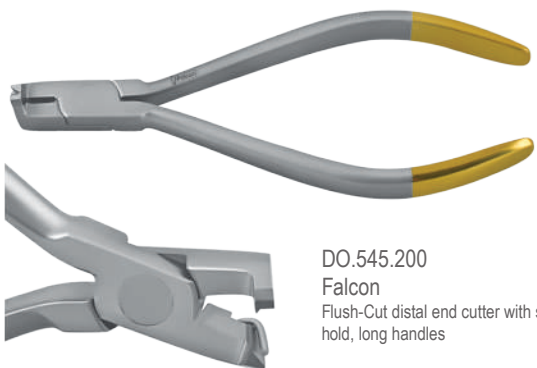

DO.545.200
Falcon
Flush-Cut distal end cutter with safety hold, long handles

- Max. 0.30 mm to 0.50 mm (.012" to .020")
- Max. 0.46 mm x 0.64 mm (.018" x .025")
- ⊗ Max. 0.38 mm to 0.53 mm (.0155" to .0215")
- ⊗ Max. 0.53 mm x 0.64 mm (.021" x .025")

Pliers for "Fixed Appliance Technique"

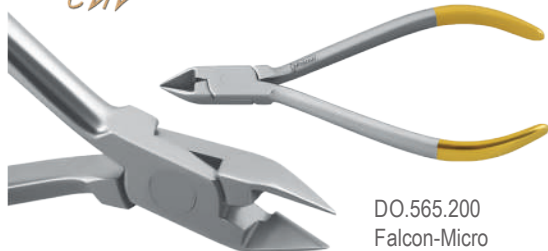

DO.565.200
Falcon-Micro
Soft wire and ligature cutter,
Micro

.25 mm to .38 mm (.010" to .015")

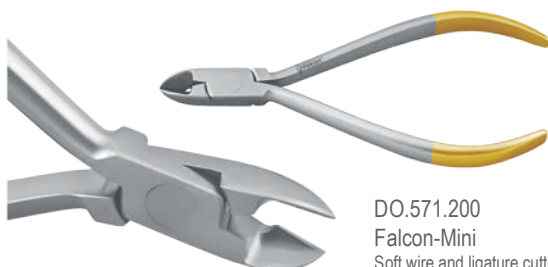

DO.571.200
Falcon-Mini
Soft wire and ligature cutter,
Mini

.25 mm to .38 mm (.010" to .015")

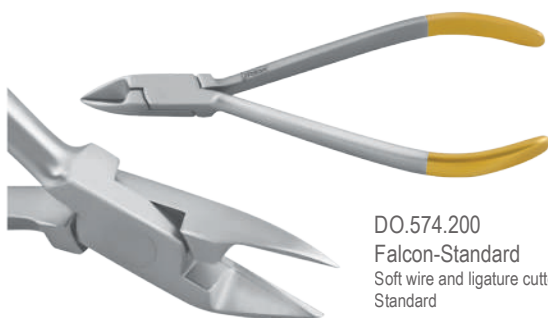

DO.574.200
Falcon-Standard
Soft wire and ligature cutter,
Standard

.25 mm to .38 mm (.010" to .015")

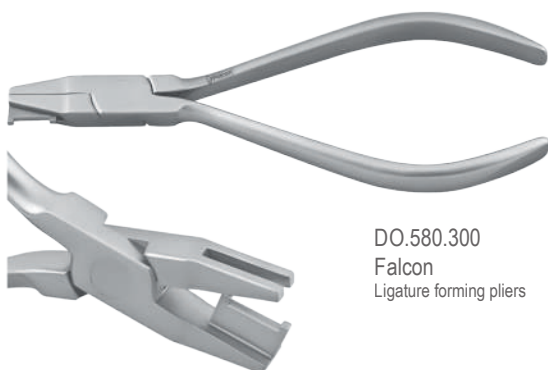

DO.580.300
Falcon
Ligature forming pliers

.25 mm to .38 mm (.010" to .015")

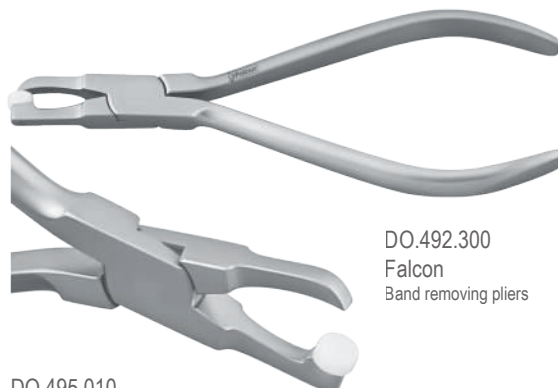

DO.492.300
Falcon
Band removing pliers

DO.495.010
Replacement pads 4.8 mm (1/4"), 2 pieces

DO.495.020
Replacement pads 6.3 mm (3/16"), 2 pieces

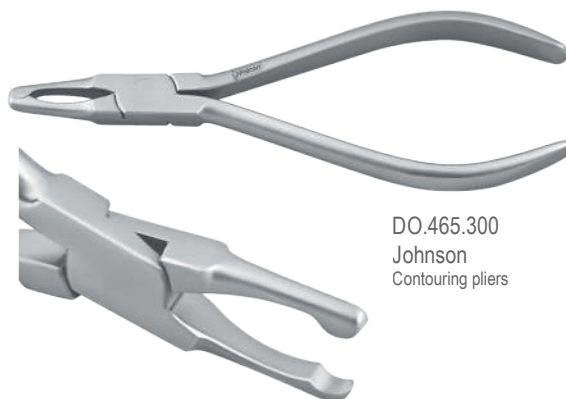

DO.465.300
Johnson
Contouring pliers

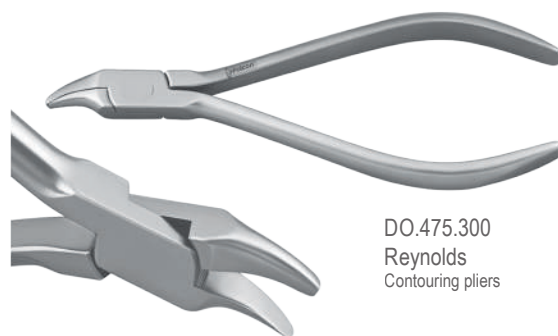

DO.475.300
Reynolds
Contouring pliers

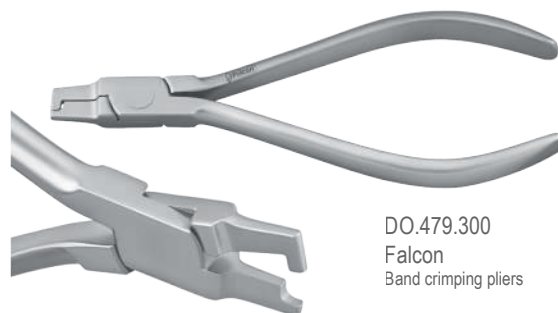

DO.479.300
Falcon
Band crimping pliers

Pliers for "Fixed Appliance Technique"

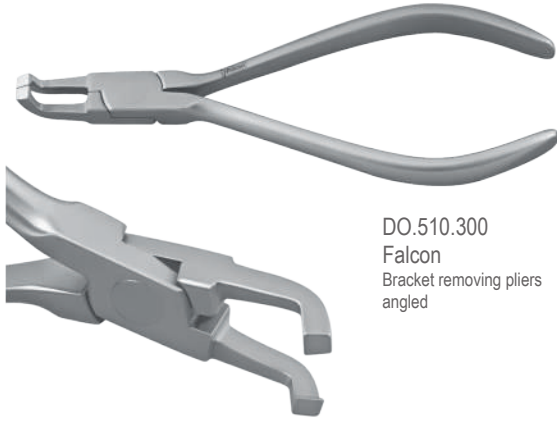

DO.510.300
Falcon
Bracket removing pliers
angled

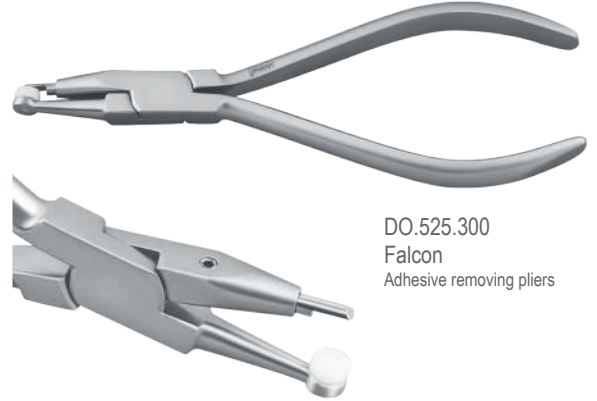

DO.525.300
Falcon
Adhesive removing pliers

DO.525.010
Replacement metal tip

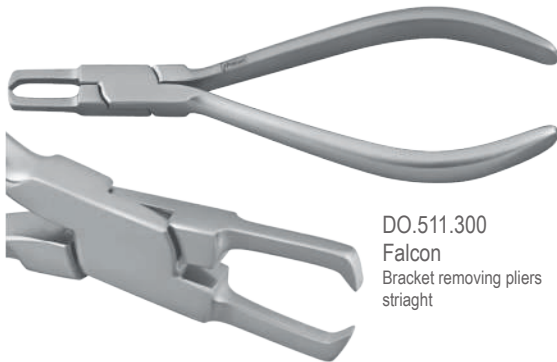

DO.511.300
Falcon
Bracket removing pliers
straight

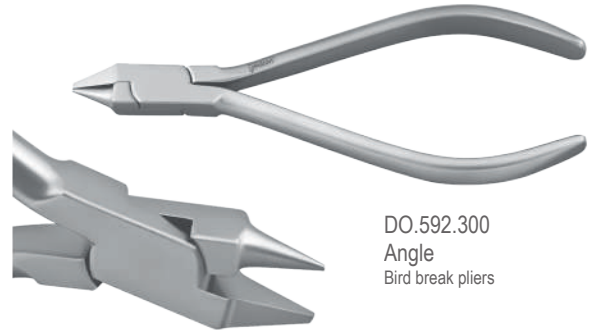

DO.592.300
Angle
Bird break pliers

● 0.36 mm to 0.71 mm (.014" to .028")

■ Max. 0.56 mm x 0.71 mm (.022" x .028")

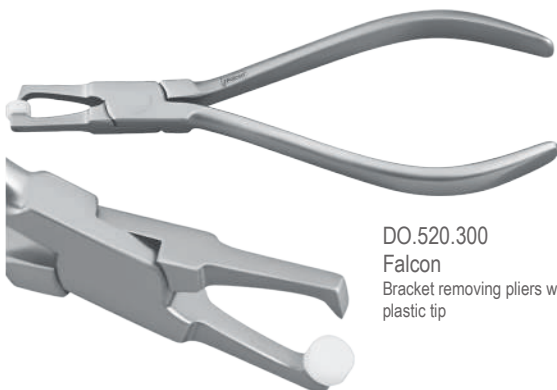

DO.520.300
Falcon
Bracket removing pliers with
plastic tip

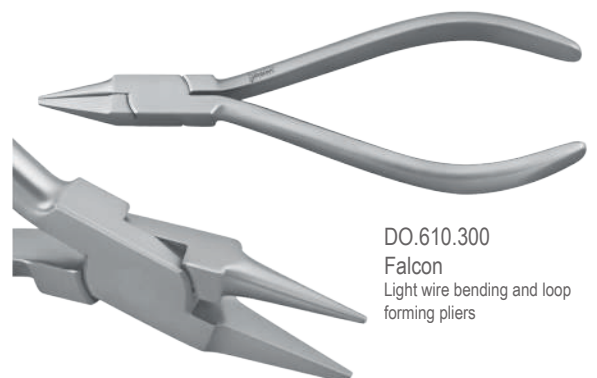

DO.610.300
Falcon
Light wire bending and loop
forming pliers

● 0.36 mm to 0.50 mm (.012" to .020")

■ Max. 0.41 mm x 0.56 mm (.016" x .022")

Pliers for "Fixed Appliance Technique"

Falcon
GRIP With Tungsten Carbide Inserts

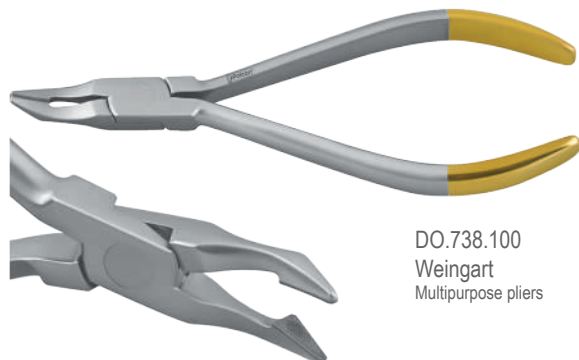

DO.738.100
Weingart
Multipurpose pliers

- Max. 0.30 mm to 0.50 mm (.012" to .020")
- Max. 0.56 mm x 0.71 mm (.022" x .028")

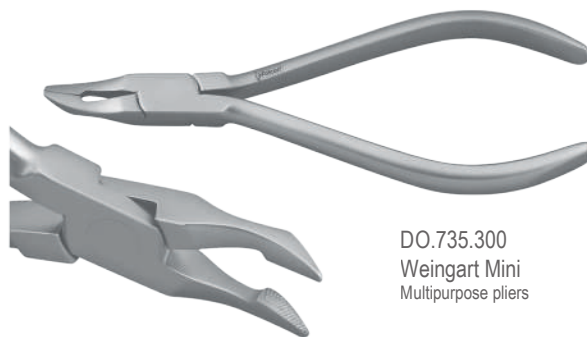

DO.735.300
Weingart Mini
Multipurpose pliers

- Max. 0.30 mm to 0.50 mm (.012" to .020")
- Max. 0.56 mm x 0.71 mm (.022" x .028")

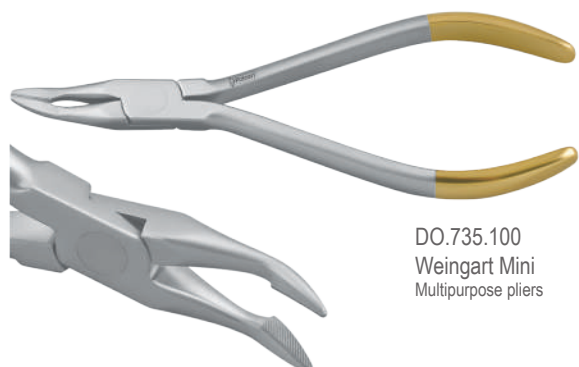

DO.735.100
Weingart Mini
Multipurpose pliers

- Max. 0.30 mm to 0.50 mm (.012" to .020")
- Max. 0.56 mm x 0.71 mm (.022" x .028")

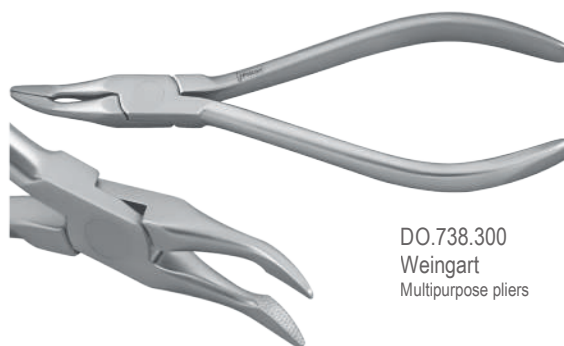

DO.738.300
Weingart
Multipurpose pliers

- Max. 0.30 mm to 0.50 mm (.012" to .020")
- Max. 0.56 mm x 0.71 mm (.022" x .028")

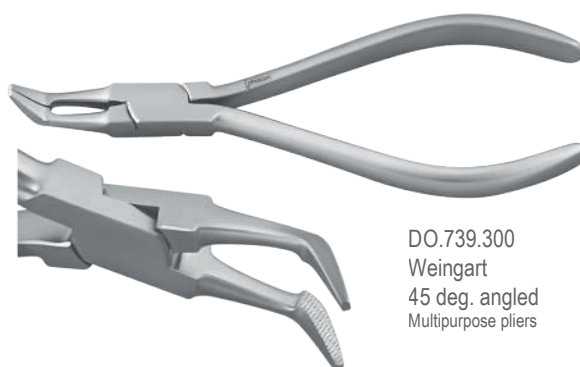

DO.739.300
Weingart
45 deg. angled
Multipurpose pliers

- Max. 0.30 mm to 0.50 mm (.012" to .020")
- Max. 0.56 mm x 0.71 mm (.022" x .028")

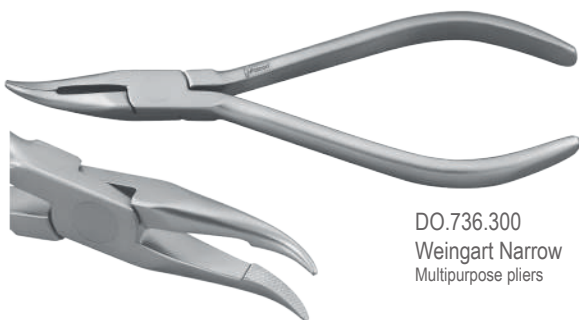

DO.736.300
Weingart Narrow
Multipurpose pliers

- Max. 0.30 mm to 0.50 mm (.012" to .020")
- Max. 0.56 mm x 0.71 mm (.022" x .028")

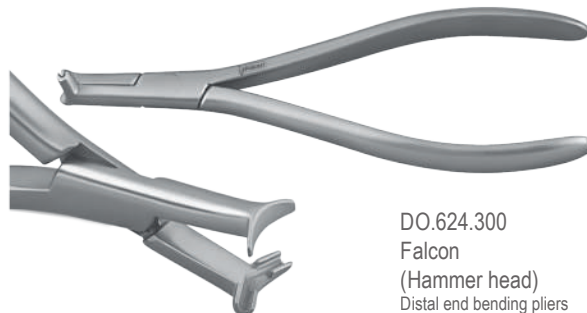

DO.624.300
Falcon
(Hammer head)
Distal end bending pliers

- Max. 0.30 mm to 0.50 mm (.012" to .020")
- Max. 0.56 mm x 0.71 mm (.022" x .028")

Pliers for "Fixed Appliance Technique"

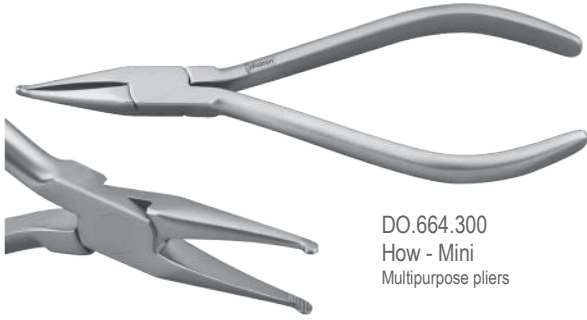

DO.664.300
How - Mini
Multipurpose pliers

- 0.30 mm to 0.50 mm (.012" to .020")
- Max. 0.56 mm x 0.71 mm (.022" x .028")



DO.665.300
How - Mini
Multipurpose pliers

- 0.30 mm to 0.50 mm (.012" to .020")
- Max. 0.56 mm x 0.71 mm (.022" x .028")

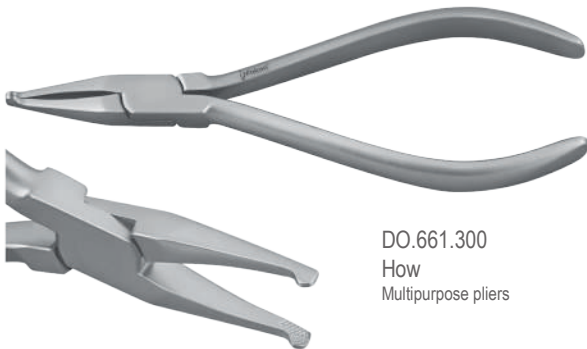

DO.661.300
How
Multipurpose pliers

- 0.30 mm to 0.50 mm (.012" to .020")
- Max. 0.56 mm x 0.71 mm (.022" x .028")

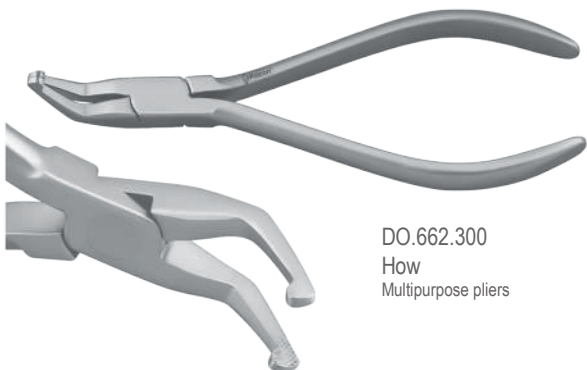

DO.662.300
How
Multipurpose pliers

- 0.30 mm to 0.50 mm (.012" to .020")
- Max. 0.56 mm x 0.71 mm (.022" x .028")



DO.600.300
De La Rosa
Arch forming and contouring plier

- 0.36 mm to 0.50 mm (.012" to .020")
- Max. 0.53 mm x 0.64 mm (.021" x .025")

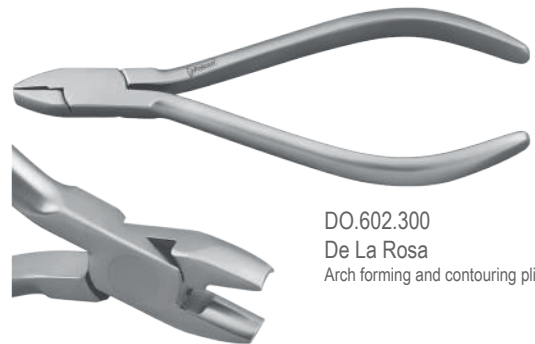

DO.602.300
De La Rosa
Arch forming and contouring plier

- 0.36 mm to 0.50 mm (.012" to .020")
- Max. 0.53 mm x 0.64 mm (.021" x .025")



DO.613.300
Hollow-Chop
Archwire forming pliers, concave and convex tips

- 0.30 mm to 0.71 mm (.012" to .020")
- Max. 0.56 mm x 0.71 mm (.022" x .028")

Orthodontic

Pliers for "Fixed Appliance Technique"

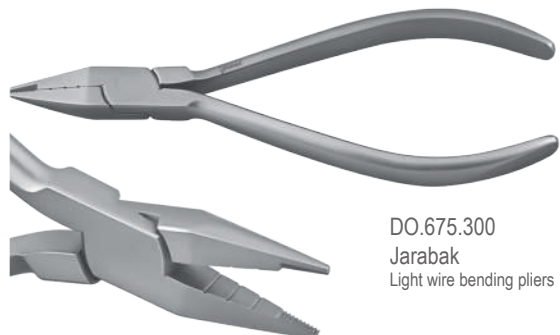

DO.675.300
Jarabak
Light wire bending pliers

- 0.30 mm to 0.50 mm (.012" to .020")
- Max. 0.46 mm x 0.56 mm (.018" x .022")

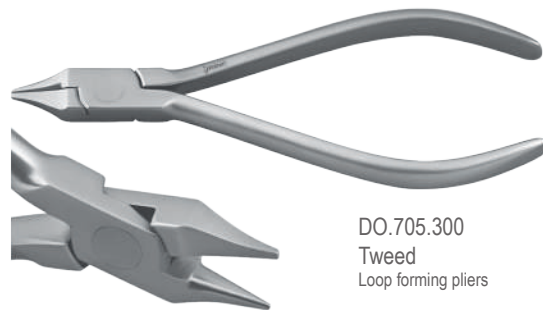

DO.705.300
Tweed
Loop forming pliers

- 0.30 mm to 0.50 mm (.012" to .020")
- Max. 0.46 mm x 0.56 mm (.018" x .022")

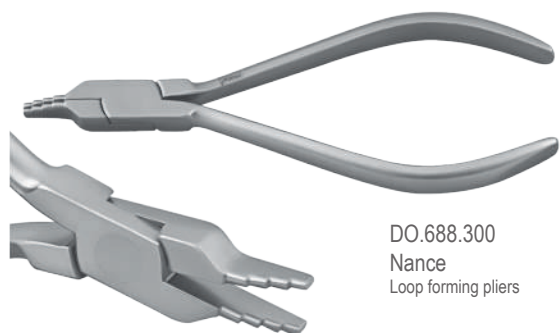

DO.688.300
Nance
Loop forming pliers

- 0.36 mm to 0.71 mm (.014" to .028")
- Max. 0.56 mm x 0.71 mm (.022" x .028")

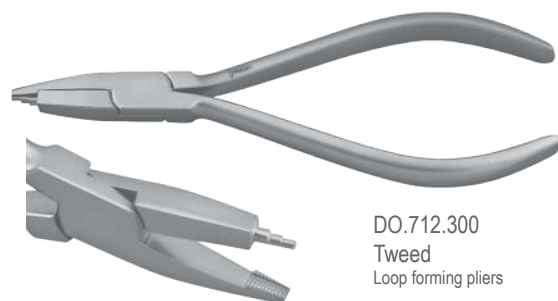

DO.712.300
Tweed
Loop forming pliers

- Max. 0.36 mm to 0.64 mm (.014" to .025")
- Max. 0.53 mm x 0.64 mm (.021" x .025")

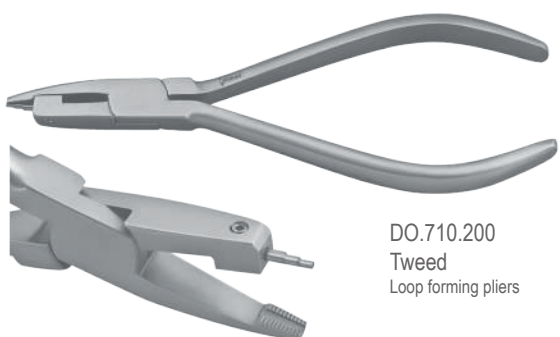

DO.710.200
Tweed
Loop forming pliers

- Max. 0.36 mm to 0.64 mm (.014" to .025")
- Max. 0.53 mm x 0.64 mm (.021" x .025")



DO.700.010
Replacement tip

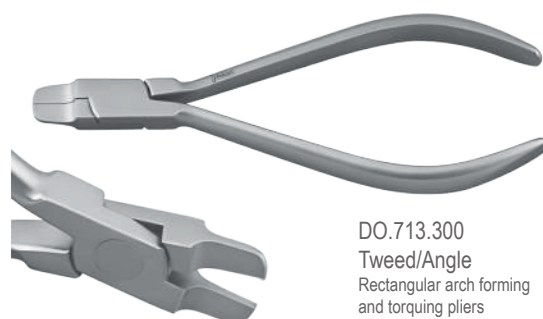

DO.713.300
Tweed/Angle
Rectangular arch forming
and torquing pliers

- Max. 0.30 mm to 0.71 mm (.012" to .028")
- Max. 0.56 mm x 0.71 mm (.022" x .028")

Pliers for "Fixed Appliance Technique"

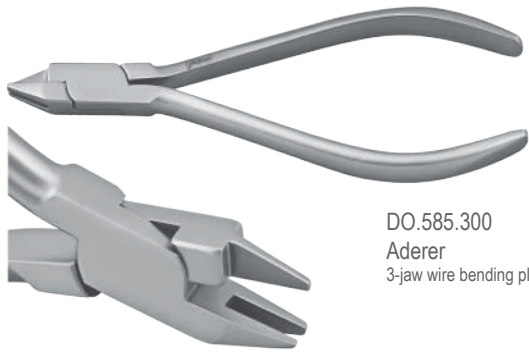

DO.585.300
Aderer
3-jaw wire bending pliers

● 0.36 mm to 0.76 mm (.014" to .030")
■ Max. 0.56 mm x 0.71 mm (.022" x .028")

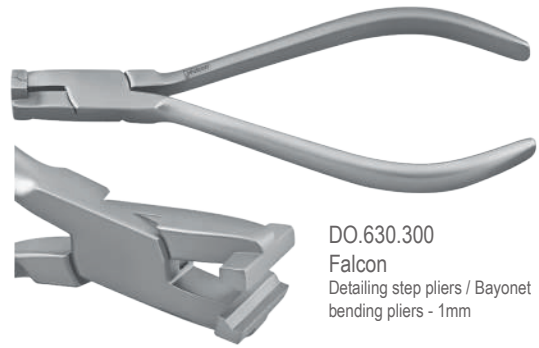

DO.630.300
Falcon
Detailing step pliers / Bayonet
bending pliers - 1mm

● 0.30 mm to 0.50 mm (.012" to .020")
■ Max. 0.56 mm x 0.71 mm (.022" x .028")

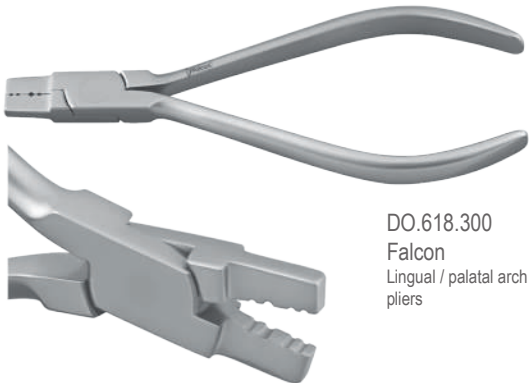

DO.618.300
Falcon
Lingual / palatal arch forming
pliers

● 0.76 mm (.030") / 0.91 mm (.036")

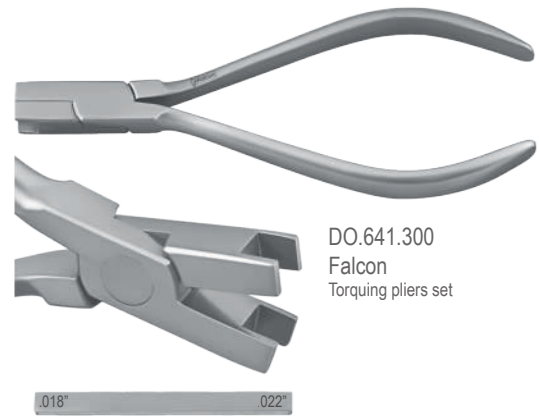

DO.641.300
Falcon
Torquing pliers set

.018" .022"

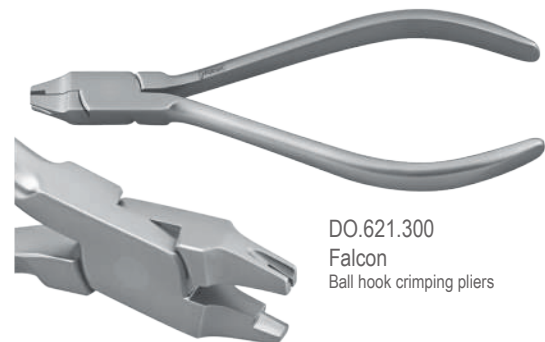

DO.621.300
Falcon
Ball hook crimping pliers

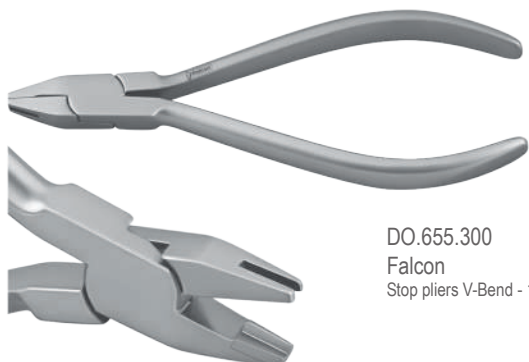

DO.655.300
Falcon
Stop pliers V-Bend - 1mm

● 0.30 mm to 0.50 mm (.012" to .020")
■ Max. 0.43 mm x 0.56 mm (.017" x .022")

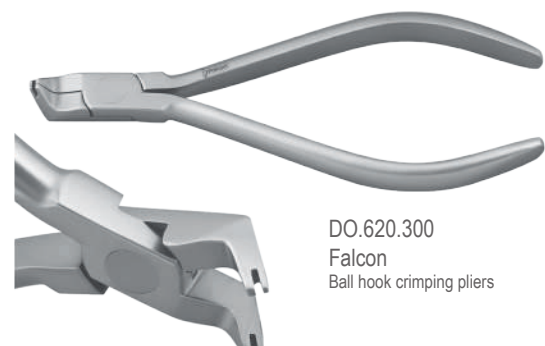

DO.620.300
Falcon
Ball hook crimping pliers

Pliers for Aligners

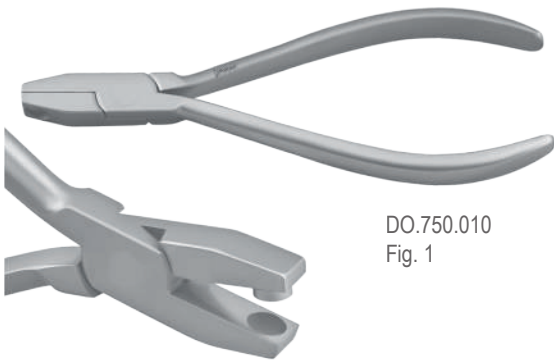

DO.750.010
Fig. 1

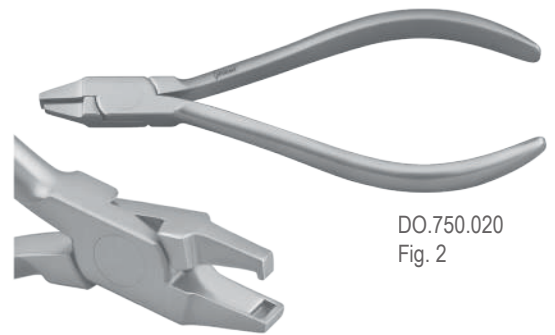

DO.750.020
Fig. 2

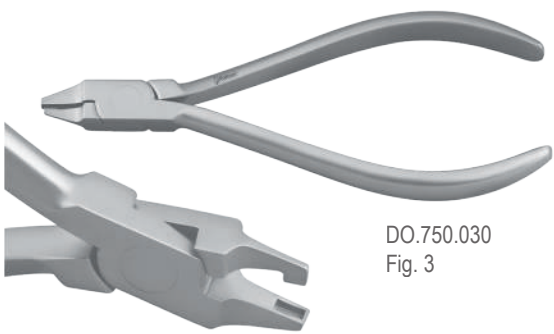

DO.750.030
Fig. 3

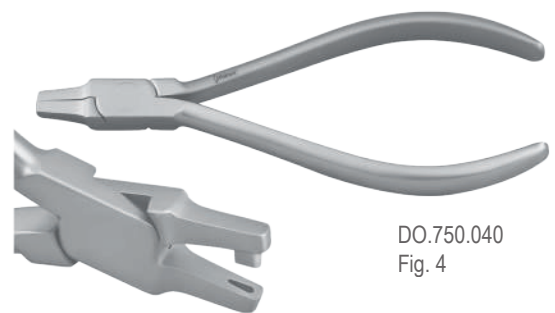

DO.750.040
Fig. 4

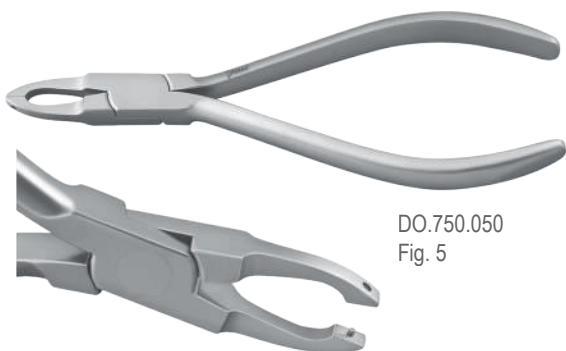

DO.750.050
Fig. 5

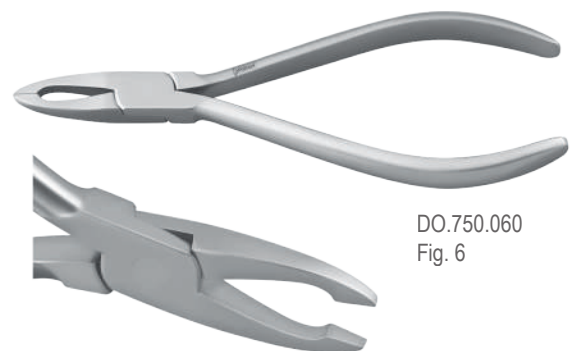

DO.750.060
Fig. 6



Pliers for "Removable Appliance Technique"

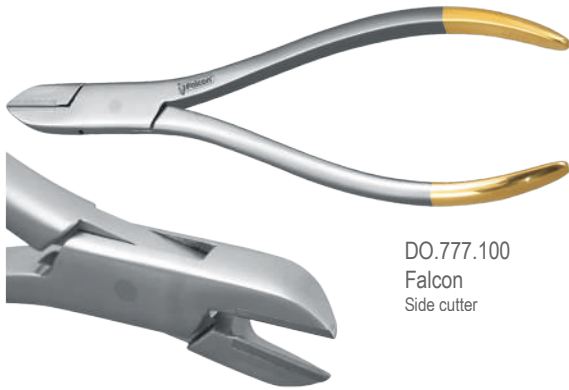

DO.777.100
Falcon
Side cutter

● 0.70 mm to 1.00 mm (.028" to .040")

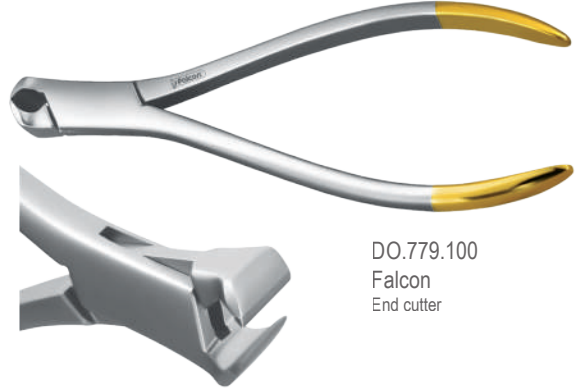

DO.779.100
Falcon
End cutter

● 0.70 mm to 1.00 mm (.028" to .040")

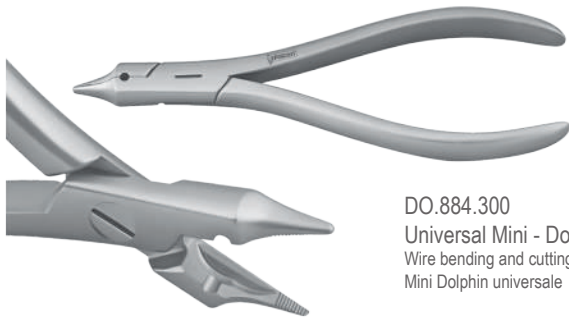

DO.884.300
Universal Mini - Dolphin style
Wire bending and cutting pliers
Mini Dolphin universale

● Bends / Piega : 0.9 mm (.036")
Cuts / Taglia : 0.7 mm (.028")

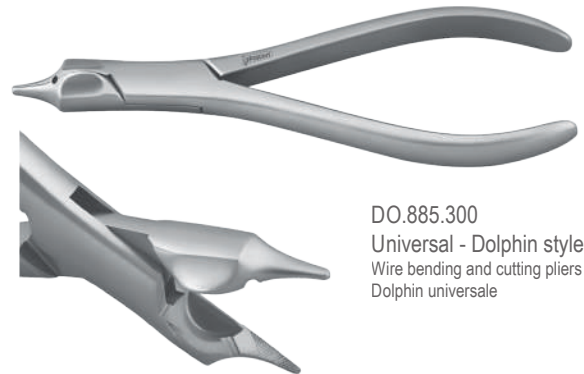

DO.885.300
Universal - Dolphin style
Wire bending and cutting pliers
Dolphin universale

● Bends / Piega : 0.9 mm (.036")
Cuts / Taglia : 0.7 mm (.028")

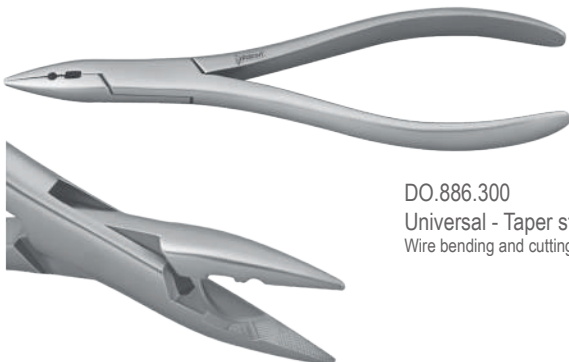

DO.886.300
Universal - Taper style
Wire bending and cutting pliers

● Bends / Piega : 0.9 mm (.036")
Cuts / Taglia : 0.7 mm (.028")



DO.895.300
Waldsachs
Wire bending and cutting pliers

● Bends / Piega : 0.9 mm (.036")
Cuts / Taglia : 0.7 mm (.028")

Pliers for "Removable Appliance Technique"

Falcon
 Heavy duty hard wire cutters
 • Compound action
 • Cut heavy wires with little force



DO.785.300
 Small
 Stainless steel, autoclavable

● 0.87 mm to 1.1 mm (.028" to .045")



DO.786.300
 Large
 Stainless steel, autoclavable

● 0.80 mm to 1.50 mm (.032" to .057")



DO.787.300
 Small
 Stainless steel, autoclavable

● 0.87 mm to 1.1 mm (.028" to .045")



DO.888.300
 Universal
 Parallel jaw pliers with side cutter, compound action
 Powerful pliers easily cuts outer bow of a facebow, serrated jaws assure non-slip grip while bending



Max. 1.80 mm (.071")

Pliers for "Removable Appliance Technique"

Adams wire bending pliers
Tips of all Adams pliers parallel at 1mm opening
box joint, available in mini and maxi sizes

Falcon[®]
GRIP With Tungsten Carbide Inserts

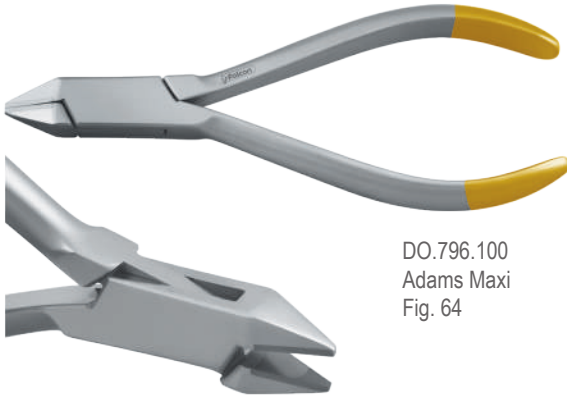

DO.796.100
Adams Maxi
Fig. 64

- 0.36 mm to 0.81 mm (.014" to .032")
- Max. 0.56 mm x 0.71 mm (.022" x .028")

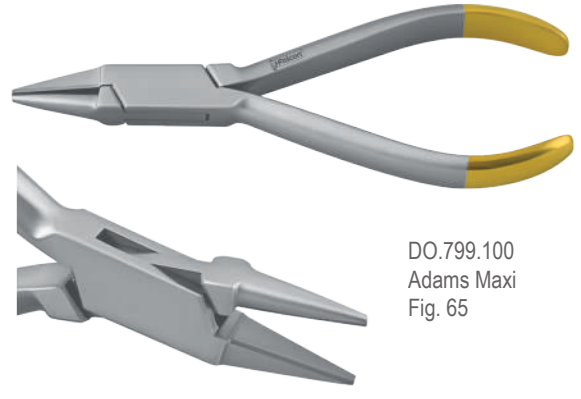

DO.799.100
Adams Maxi
Fig. 65

- 0.36 mm to 0.81 mm (.014" to .032")
- Max. 0.56 mm x 0.71 mm (.022" x .028")

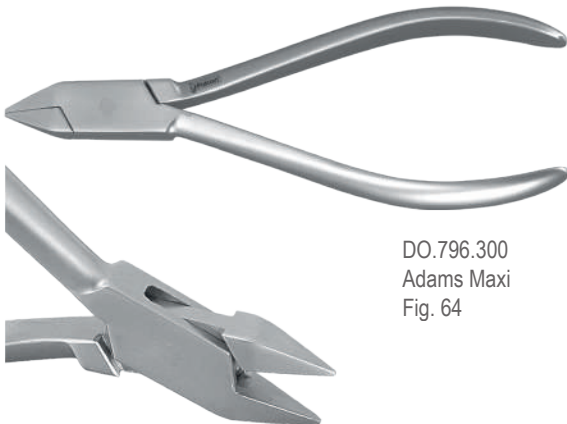

DO.796.300
Adams Maxi
Fig. 64

- 0.36 mm to 0.81 mm (.014" to .032")
- Max. 0.56 mm x 0.71 mm (.022" x .028")

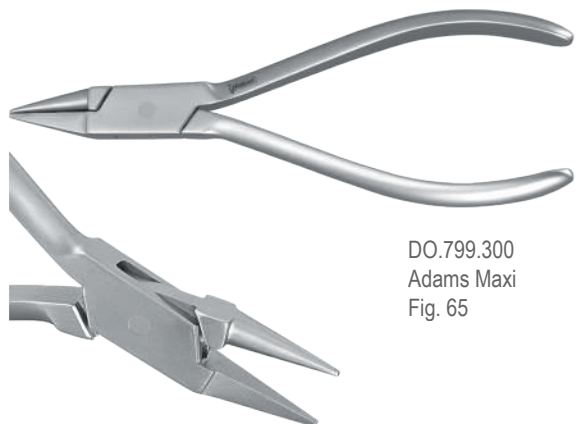

DO.799.300
Adams Maxi
Fig. 65

- 0.36 mm to 0.81 mm (.014" to .032")
- Max. 0.56 mm x 0.71 mm (.022" x .028")

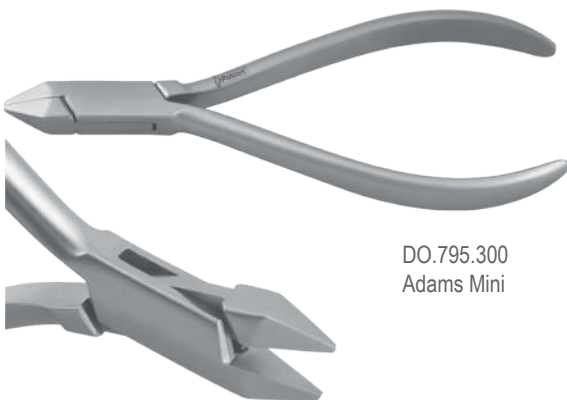

DO.795.300
Adams Mini

- 0.36 mm to 0.81 mm (.014" to .032")
- Max. 0.56 mm x 0.71 mm (.022" x .028")

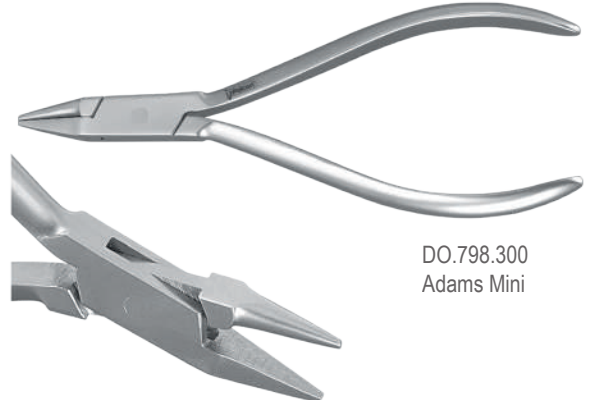

DO.798.300
Adams Mini

- 0.36 mm to 0.81 mm (.014" to .032")
- Max. 0.56 mm x 0.71 mm (.022" x .028")

Pliers for "Removable Appliance Technique"

Aderer 3-Jaw wire bending pliers
Precision aligned and contoured tips for consistent bends without damaging wire.



DO.806.300
Aderer - Mini

- 0.36 mm to 0.50 mm (.014" to .020")
- Max. 0.53 mm x 0.64 mm (.021" x .020")



DO.870.300
Schwarz Mini
Optical style, round and concave beaks.
Loop forming pliers

- Max. 0.50 mm (.020")

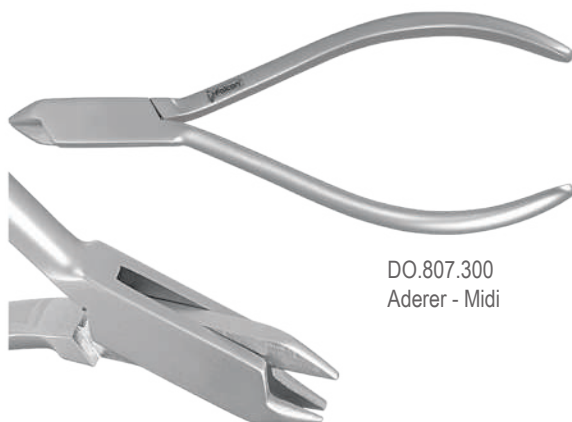

DO.807.300
Aderer - Midi

- 0.36 mm to 0.71 mm (.014" to .025")
- Max. 0.56 mm x 0.71 mm (.022" x .028")

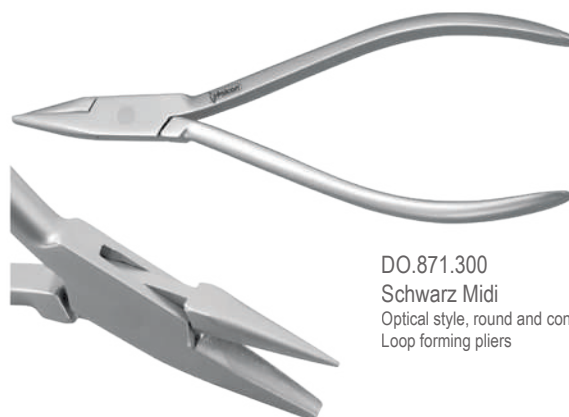

DO.871.300
Schwarz Midi
Optical style, round and concave beaks.
Loop forming pliers

- Max. 0.70 mm (.028")



DO.808.300
Aderer - Maxi

- 0.50 mm to 0.91 mm (.020" to .036")
- Max. 0.56 mm x 0.71 mm (.022" x .028")



DO.872.300
Schwarz Maxi
Optical style, round and concave beaks.
Loop forming pliers

- Max. 0.70 mm (.028")

Pliers for "Removable Appliance Technique"



DO.874.300
Schwarz graduated
Optical style, round and concave beaks.
Loop forming pliers. Graduation prevents
wire slippage

● Max. 0.70 mm (.028")

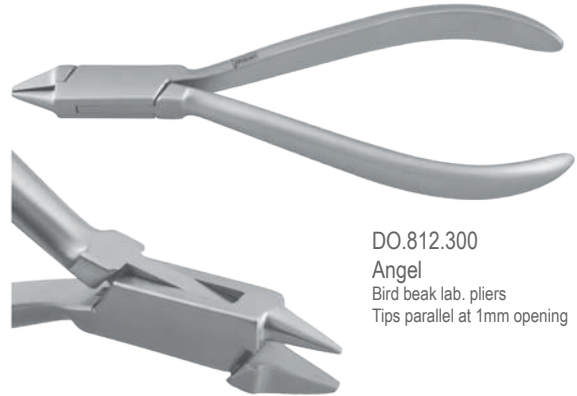

DO.812.300
Angel
Bird beak lab. pliers
Tips parallel at 1mm opening

● 0.36 mm to 0.71 mm (.014" to .028")

■ Max. 0.56 mm x 0.71 mm (.022" x .028")

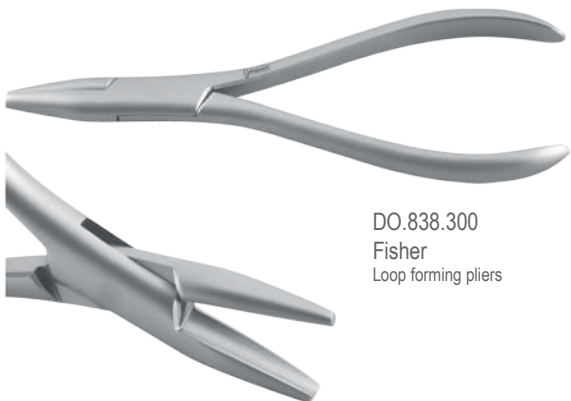

DO.838.300
Fisher
Loop forming pliers

● 0.36 mm to 0.64 mm (.014" to .025")

■ Max. 0.53 mm x 0.64 mm (.021" x .025")

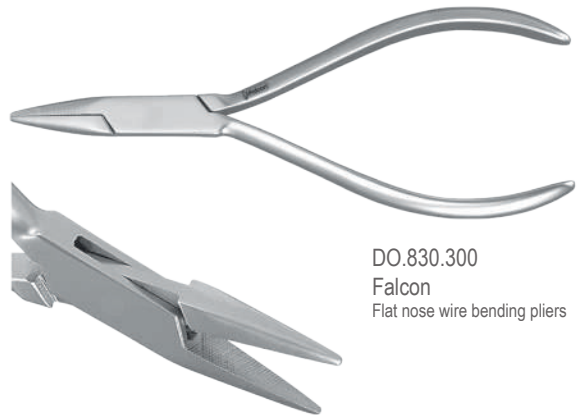

DO.830.300
Falcon
Flat nose wire bending pliers

● 0.36 mm to 0.71 mm (.014" to .028")

■ Max. 0.56 mm x 0.71 mm (.022" x .028")

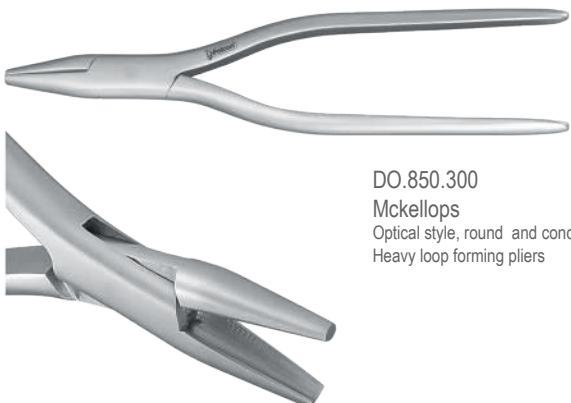

DO.850.300
Mckellops
Optical style, round and concave beaks.
Heavy loop forming pliers

● Max. 0.80 mm (.032")

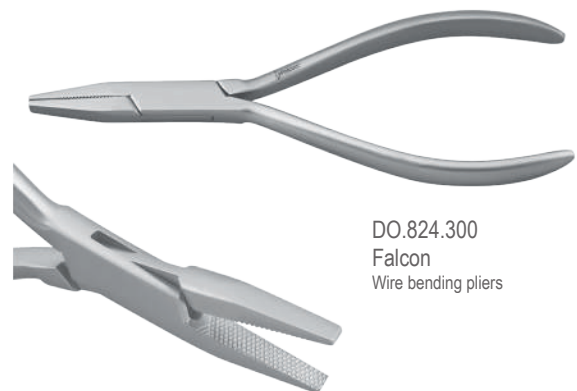

DO.824.300
Falcon
Wire bending pliers

● 0.36 mm to 0.64 mm (.014" to .025")

■ Max. 0.53 mm x 0.64 mm (.021" x .025")

Pliers for "Removable Appliance Technique"

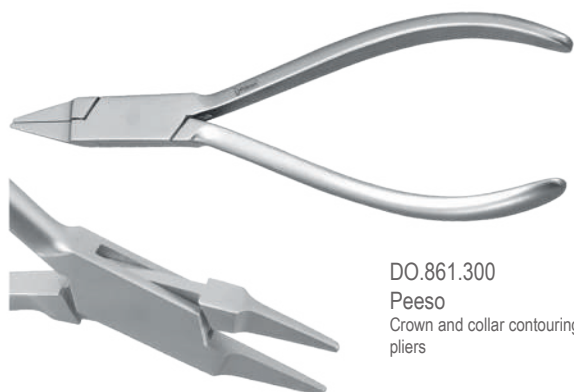

DO.861.300
Peeso
Crown and collar contouring
pliers

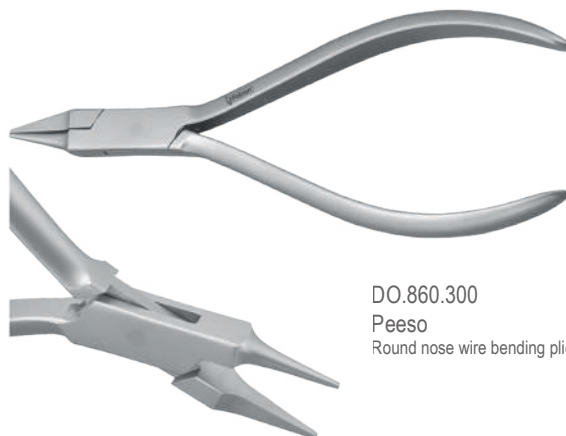

DO.860.300
Peeso
Round nose wire bending pliers

● 0.36 mm to 0.71 mm (.014" to .028")
■ Max. 0.56 mm x 0.71 mm (.022" x .028")

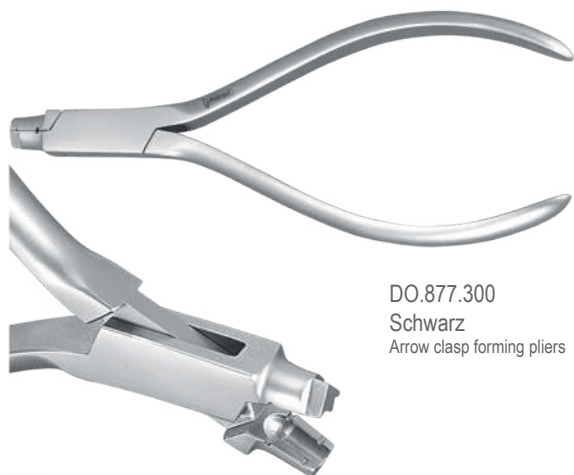

DO.877.300
Schwarz
Arrow clasp forming pliers

■ Max. 0.70 mm (.028")

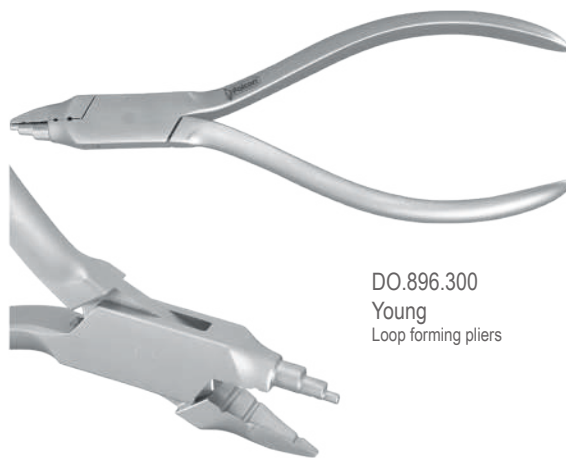

DO.896.300
Young
Loop forming pliers

● 0.36 mm to 0.71 mm (.014" to .028")
■ Max. 0.56 mm x 0.71 mm (.022" x .028")

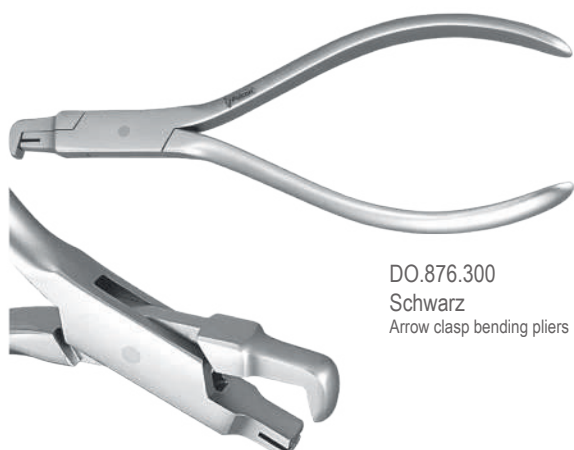

DO.876.300
Schwarz
Arrow clasp bending pliers

■ Max. 0.70 mm (.028")

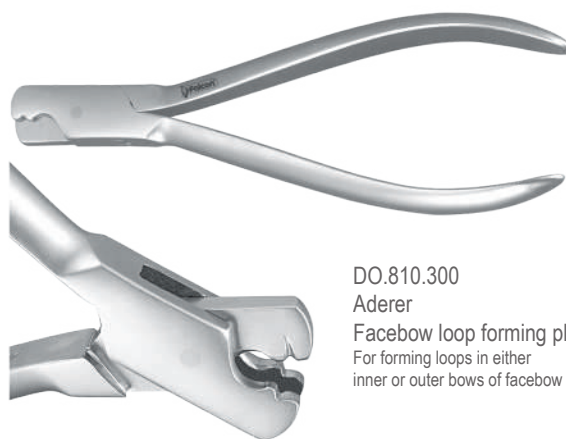

DO.810.300
Aderer
Facebow loop forming pliers
For forming loops in either
inner or outer bows of facebow

■ Max. 1.60 mm (.063")

Pliers Stands

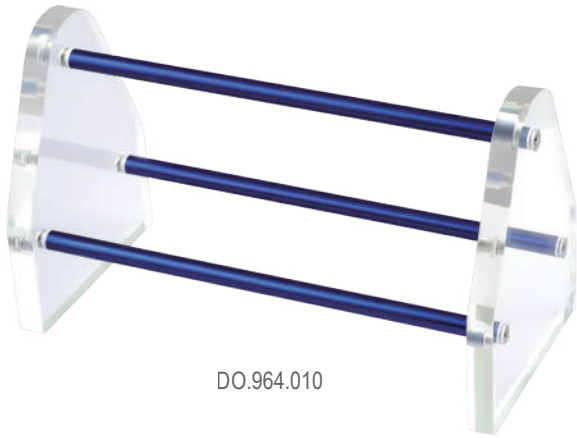

DO.964.010

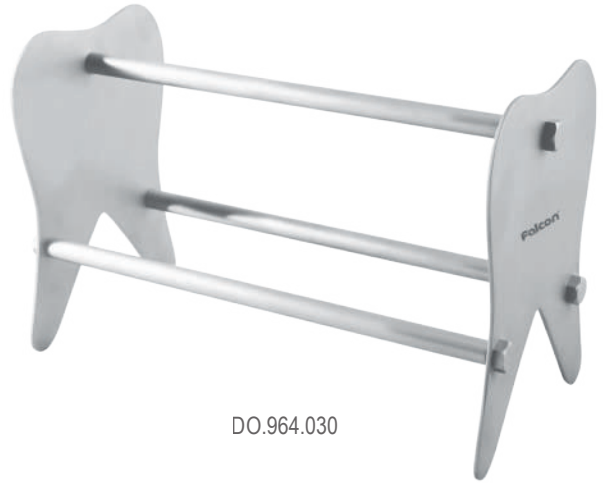

DO.964.030



DO.963.010
Mini
95 x 125 mm

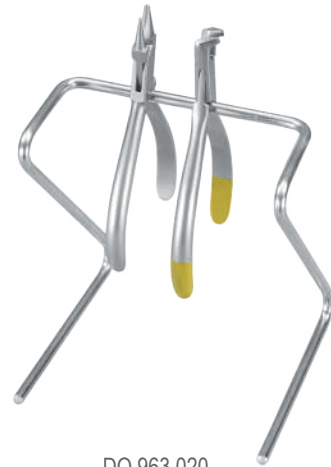

DO.963.020
Midi
110 x 125 mm



DO.963.030
Maxi
155 x 125 mm



DO.963.040
X-Large
310 x 125 mm

Colour Coding Rings



Color	Small	Large	Pack
Assorted	DZ.080.000	DZ.081.000	50 pz.
Black	DZ.080.010	DZ.081.010	50 pz.
Blue Dark	DZ.080.020	DZ.081.020	50 pz.
Blue Light	DZ.080.030	DZ.081.030	50 pz.
Brown	DZ.080.050	DZ.081.050	50 pz.
Grey	DZ.080.080	DZ.081.080	50 pz.
Green	DZ.080.090	DZ.081.090	50 pz.
Orange	DZ.080.110	DZ.081.110	50 pz.
Pink	DZ.080.130	DZ.081.130	50 pz.
Red	DZ.080.150	DZ.081.150	50 pz.
White	DZ.080.170	DZ.081.170	50 pz.
Yellow	DZ.080.180	DZ.081.180	50 pz.

- Small: inner Ø4mm
- Large: inner Ø6mm

Moderna Sterilization Cassettes

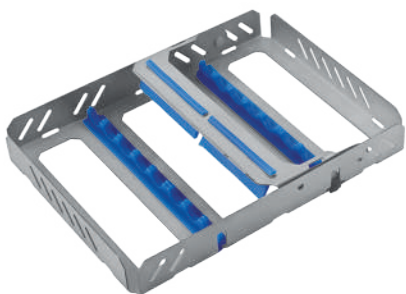

DZ.092.030	3 instruments
DZ.092.050	5 instruments
DZ.092.070	7 instruments
DZ.092.080	8 instruments
DZ.092.100	10 instruments

Petite Sterilization Cassettes

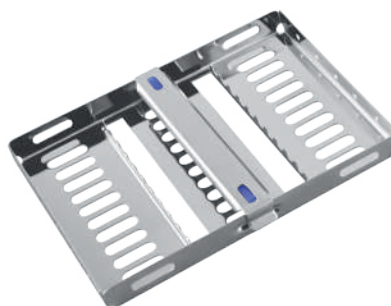

DZ.094.000	3 instruments
DZ.095.000	5 instruments
DZ.095.010	7 instruments
DZ.095.020	10 instruments

Twist-Lock Sterilization Cassettes

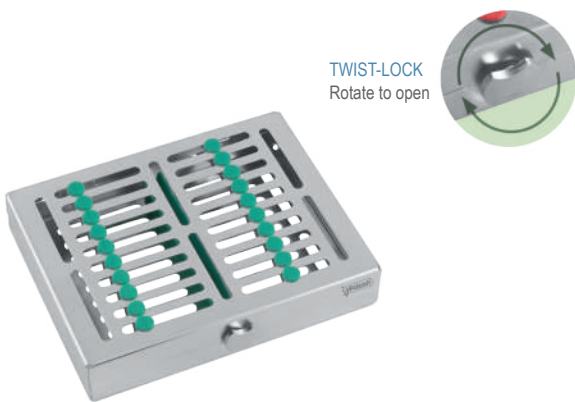

	Mini - 5 Instruments 182 x 72 x 34 mm	Midi - 10 Instruments 182 x 144 x 34 mm	Maxi - 20 Instruments 288 x 182 x 34 mm
Blue	DZ.086.010	DZ.086.020	DZ.086.030
Green	DZ.086.013	DZ.086.023	DZ.086.033
Red	DZ.086.015	DZ.086.025	DZ.086.035
Yellow	DZ.086.019	DZ.086.029	DZ.086.039



Sterilization Cassettes



	Mini - 5 Instruments 180 x 60 x 22 mm	Midi - 10 Instruments 180 x 125 x 22 mm	Maxi - 20 Instruments 280 x 180 x 25 mm
Blue	DZ.085.010	DZ.085.020	DZ.085.030
Green	DZ.085.013	DZ.085.023	DZ.085.033
Red	DZ.085.015	DZ.085.025	DZ.085.035
Yellow	DZ.085.019	DZ.085.029	DZ.085.039



Instrument Trays Stainless Steel, Maxi



DZ.430.000 Maxi set 1
Solid cover + Perforated tray + Rack for 15 instruments
288 x 187 x 40 mm



DZ.431.000 Maxi set 2
Perforated cover + Perforated tray + Rack for 15 instruments
288 x 187 x 40 mm



DZ.432.000 Maxi set 3
Solid cover + Solid tray + Rack for 15 instruments
288 x 187 x 40 mm



DZ.430.010
Solid cover
288 x 187 x 29 mm



DZ.430.020
Perforated cover
288 x 187 x 29 mm



DZ.430.030
Perforated tray
284 x 183 x 19 mm



DZ.430.040
Solid tray
284 x 183 x 19 mm



DZ.430.070 for 15 instruments
DZ.430.071 for 17 instruments
DZ.430.080 for 23 instruments

Instrument Trays Stainless Steel, Midi

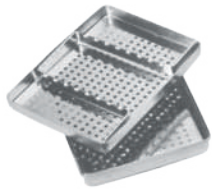

DZ.425.010 Solid cover only
DZ.425.020 Perforated cover only
187 x 145 x 25mm



DZ.425.030 Perforated tray only
DZ.425.040 Solid tray only
183 x 140 x 17mm



DZ.408.010 for 8 instruments
DZ.408.020 for 4 instruments

Instrument Boxes



DZ.467.000
180 x 90 x 30 mm

Instrument Trays Stainless Steel



Fig. 1
DZ.420.010
185 x 80 x 15 mm



Fig. 3
DZ.420.030
190 x 100 x 25 mm



Fig. 4
DZ.420.040
190 x 100 x 15 mm



DZ.420.020 Small, 190 x 100 x 17 mm
DZ.420.021 Medium, 190 x 135 x 17 mm
DZ.420.022 Large, 290 x 215 x 17 mm



DZ.420.031
Cover for DZ.420.030



Fig. 5
DZ.420.050
190 x 135 x 15 mm



	A mm	B mm	C mm
DZ.465.000	180	90	30
DZ.470.000	180	100	30
SH.056.100	200	100	50
SH.056.125	200	125	50
SH.062.125	250	125	60
SH.062.150	250	150	60

Sterilization and Sundries

Instrument Trays Stainless Steel



	A mm	B mm	C mm
SH.152.075	125	75	25
SH.155.120	150	120	30
SH.220.150	200	150	40
SH.227.200	250	200	50
SH.234.250	350	250	50
SH.242.350	455	350	50

Trays with Lid Stainless Steel



SH.224.150S	Small, 230 x 150 x 50 mm
SH.227.200S	Medium, 250 x 200 x 50 mm
SH.230.200S	Large, 300 x 200 x 50 mm

Drums Stainless Steel



	Ø x H mm
SS.850.125	125 x 125
SS.850.140	140 x 140
SS.850.150	150 x 150

Kidney Trays Stainless Steel



SH.570.150	150 mm
SH.570.180	180 mm
SH.570.200	200 mm
SH.570.250	250 mm

Bowls Stainless Steel



SH.606.090	90 mm
SH.606.100	100 mm
SH.606.125	125 mm
SH.606.150	150 mm
SH.606.200	200 mm

Gallipots Stainless Steel



	Ø mm	H mm
SH.600.010	1 oz	54 29
SH.600.020	2 oz	64 35
SH.600.030	3 oz	70 40
SH.600.040	4 oz	76 44
SH.600.060	6 oz	85 49
SH.600.080	8 oz	90 50
SH.600.090	9 oz	95 57
SH.600.120	12 oz	105 64

(1 oz = 28 ml)

Forceps Jars



SH.755.110	50 x 110 mm
SH.755.130	50 x 130 mm
SH.760.110	75 x 110 mm
SH.760.130	75 x 130 mm

Sterilizing Forceps

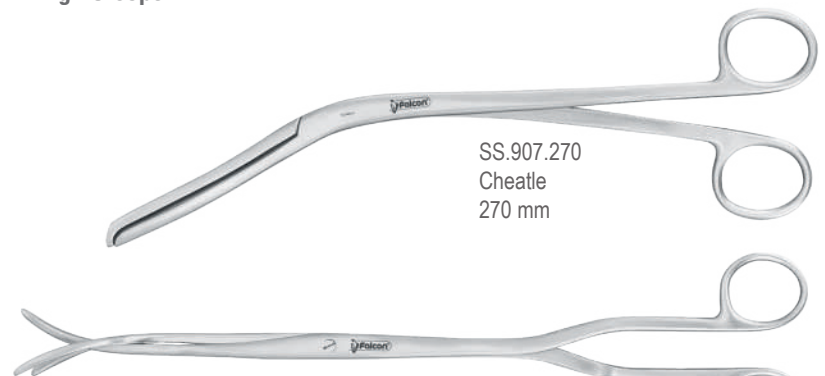

SS.907.270
Cheatele
270 mm

SS.920.200 200 mm
SS.920.300 300 mm
Collin

Bur Stands, Autoclavable



DZ.060.010
FG for 12 burs

DZ.060.020
CA/RA for 12 burs

Bur Stands, Autoclavable

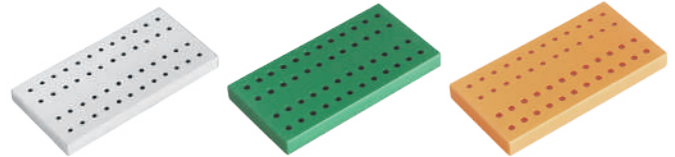

DZ.061.010
FG for 48 burs

DZ.061.020
CA/RA for 48 burs

DZ.061.030
FG & CA/RA for 48 burs

Bur Disinfecting Boxes



DZ.050.010
Plastic
Ø 85 mm x H 70 mm



DZ.051.010
Stainless steel
Ø 76 mm x H 35 mm

Mesh Bur Holder



DZ.052.010
Ø 35mm x L 150 mm

Bur Holding Tweezers



DZ.055.010
165 mm

Bib Chains



DZ.945.020



DZ.945.050

X-Ray Clip and Hangers



Fig. 1
DZ.970.010



Fig. 10
DZ.972.100
10 Clips

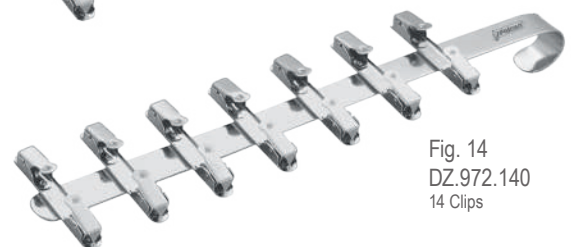

Fig. 14
DZ.972.140
14 Clips

Sterilization and Sundries

**Cotton Rolls Holder
Stainless Steel**



DZ.530.010

**Cotton Pellet Dispenser
Stainless Steel**



DZ.532.000
40 x 40 x 50 mm

**Cotton Waste Receiver
Stainless Steel**



DZ.544.010

**Cotton Container
Stainless Steel**



SH.720.075 Ø 75 x H 75 mm
SH.720.100 Ø 100 x H 100 mm

Cotton Dispensers Aluminum



DZ.535.010



DZ.535.020



DZ.535.030



DZ.535.040



DZ.535.050

Cotton Dispensers Stainless Steel



DZ.540.010



DZ.540.020

Key Rings



ZP.135.010
Laughing tooth



ZP.135.020
Rooted tooth



ZP.135.030
Perforate impression tray



ZP.135.040
Solid impression tray

A	Page
Acorn/Wescott Burnishers	26,30,33
Adams Pliers Wire Bending	137
Aderer Pliers Loop Forming /Bending	140
Aderer Pliers Wire Bending	138
Adhesive Removers	123
Adson Forceps Dissecting	96
Adson Forceps Tissue	96,97
Adson-Brown Forceps Tissue	97
Adson-Fraser Forceps Haemostatic	99
Adson-Micro Forceps Dissecting	96
Adson-Micro Forceps Tissue	96,97
Ainsworth Punches Rubber Dam	43
Albrecht Tweezers Extraction	68
Alcohol Burners	116
Alginate Bowls	116
Alginate Spatulae	116
Allen Elevators Periosteal	73
Alm Retractors Self-Retaining	105
Amalgam Carriers	31
Amalgam Pluggers	26,31,32
Amalgam Well	31
Anaesthesia Syringes	45-47
Angle Pliers Wire Bending	129,139
Apical Elevators	55
Applicator For Medicaments	36
Applicators Bone Grafting Material	87
Applicators Elastomeric Ligature	124
Applicators For Calcium Hydroxide	36
Articulating Paper Forceps	40
Articulators	113
Atraumatic Extraction	48-52
Atraumatic Extraction Forceps	51,52
Atraumatic Forceps	96
Austin Retractors Cheek	69
Austin-Kay Retractors Cheek	69
B	Page
Baby-Crilewood Needle Holders	101
Backhaus Forceps Towel	98
Band Pushers	122,123
Band Seaters	122
Bandage Scissors	95
Bands Matrix	41
Baumgartner Needle Holders	101,102
Beale Carvers Modeling	119
Beavertail Burnishers	33
Bee Bee Scissors Crown	114
Beerendonk Vernier Caliper	121
Bein Elevators	53,54,57
Benders Distal Wires	123
Bernhard Elevators	53
Bernklau Rulers	121
Beyer Rongeurs Bone	80
Bib Chains / Holders	145
Bishop Retractors Cheek	69
Bite Gauge	106
Bite Sticks	122
Black Amalgam Pluggers	26,32
Blacks Margin Trimmers	38
Blade Removing Forceps	91

B	Page
Blumenthal Rongeurs Bone	80
Boghosian Filling Instruments	27
Bohm Pliers Crown	114
Boley Gauges	114
Bone Block Clamps	82
Bone Chisels	81
Bone Curettes	76-78
Bone Cutters	81
Bone Files	79
Bone Gouges	81
Bone Graft Compactors	87
Bone Grafting Applicators	87
Bone Injectors	83
Bone Mills	83
Bone Rongeurs	80
Bone Scrapers	82
Bone Thickness Gauges	82
Bone Wells	83
Boone Gauge	121
Bow Divider Orthodontic	121
Bowdler-Henry Retractor	69
Bowls Alginate and Plaster	116
Bowls Stainless Steel	144
Boxes Endodontic	23
Boxes Stainless Steel	143
Boynton Needle Holders	103
Bracket Placing Tweezers	122
Bracket Positioning Gauges	121
Brewer Forceps Rubber Dam Clamps	43
Bruenings Depressors Tongue	70
Buccal Tube Placing Tweezers	122
Bur Stands	145
Burners Alcohol	116
Burnishers	26,30,33
Burs Disinfecting Boxes	145
Busar Elevators Periosteal	73
Buttons Silicone For Impression Trays	109

C	Page
Calipers Laboratory	114
Carvers Amalgam	28,37
Carvers For Silicone Impression Material	106
Carvers Laboratory	119,120
Cassette Trays	142
Castroviejo Bone Thickness Gauges	82
Castroviejo Needle Holders	100, 102
Cattoni Probes Periodontal	5
Cavity Preparation Instruments	28,38
Cawood-Minnesota Müller Retractors Cheek	69
Cawood-Minnesota Retractors Cheek	69
Cement Spatula	35
Ceramic Sculpturing Instruments	118
Cheatle Sterilizing Forceps	144
Cheek and Lip Retractors	10,11,69,70
Chisels Bone	81
Chisels Periodontal	71
Chompret Syndesmotomes	57
Clamp Matrix Bands	41
Clamps Bone Block	82
Cleoid-Discoïd	37

C	Page
Cleveland Cutters Bone	81
Coleman Elevators	56
College Tweezers	6
College-TOE Tweezers	6
Collin Sterilizing Forceps	144
Colour Code Rings	142
Columbia Curettes	15
Columbia Retractors Cheek	70
Compactors Bone Graft	87
Compo-Art Instruments	24,25
Compo-Fill Instruments	26,27
Condensing Osteotomes	84-85
Contrastors	10
Cotton Holders and Dispensers	146
Coupland Elevators	53,55
Crane-Kaplan Scalers	16
Crile Forceps Haemostatic	99
Crile-Rankin Forceps Haemostatic	99
Crilewood Needle Holders	100, 102
Crown Forceps	114
Crown Instruments	39,40
Crown Pliers	40,114
Crown Removers	39-40
Crown Scissors	114
Crown Spreaders	40
Cryer Elevators	53,55,56,57
Curettes Bone	76-78
Curettes Endodontics	22
Curettes Periodontal	12-15
Curettes Sinus Lift	86,87
Cutters Bone	81
Cutters Distal End	127
Cutters Ligature	128
Cutters Plaster	115
Cutters Wire	127,135,136

D	Page
Darby Perry Scalers	17
De Bakey Forceps Atraumatic	96
De La Rosa Pliers Arch Contouring	131
Dental Surgery	69-81
Depressors Tongue	70
Derf Needle Holders	100, 102
Diagnostic Instruments	2-7
Disc-System Syringes Self Aspirating	47
Disguise Forceps Extraction	60
Dispensers Cotton	146
Dissecting Forceps	96,97
Distal end bending instruments	123
Distal End Cutters	127
Dolphin Pliers Universal	135
Dressing Forceps	98
Drums Stainless Steel	144

E	Page
Ehrlicke Pattern Impression Trays	110,111
Elastomeric Ligature Applicators	124
Elevators	53-59
Elevators Periosteal	73-75
Elevators Root Tips	53,56,58

Alphabetical Index

A	Page
Elevators Sinus Lift	86,87
Endodontic Boxes	23
Endodontic Cleaner	23
Endodontic Curettes	22
Endodontic Excavators	18
Endodontic Explorers	18
Endodontic Forceps	22
Endodontic Instruments	18-23
Endodontic Instruments Holder	23
Endodontic Micro Applicators	21
Endodontic Micro Pluggers/Burnishers	21
Endodontic Pluggers	19,20
Endodontic Retractors	21
Endodontic Spreaders	19,20
Endodontic Trays	23
Endodontic Tweezers	22
Endometers	23
Ermerl Knives Wax	117
Euro Syringes Manual Aspirating	45-46
Examination Kits	7
Excavators	29,38
Excavators Endodontic	18
Explorers	3,4
Explorers Endodontics	18
Expos	3,4,5
Extraction Forceps	60-68
Extraction Instruments	53-68
Extraction Instruments Sets	62
Extraction Tweezers	68

F	Page
Fahnenstock Knives Wax	117,118
Falcon Articulators	113
Falcon Bite Gauge	106
Falcon Bone Thickness Gauges	82
Falcon Burnishers	33
Falcon Carvers Modeling	119,120
Falcon Crown Removers	39-40
Falcon Crown Spreader	40
Falcon Curettes Sinus Lift	86-87
Falcon Cutters Bone	81
Falcon Distal End Bending Pliers (Hammer head)	130
Falcon Elevators	53
Falcon Elevators Sinus Lift	86-87
Falcon Excavators	38
Falcon Excavators Endodontics	18
Falcon Filling Instruments	27,30,34
Falcon Forceps For Articulating Paper	40
Falcon Forceps Matrix	41
Falcon Forceps Rubber Dam Clamps	43
Falcon Knives Plaster	117
Falcon Luxators	50
Falcon Mallets Bone	81,83
Falcon Osteotomes Implant	84,85
Falcon Pliers Adhesive Removing	129
Falcon Pliers Band Removing	128
Falcon Pliers Bracket Removing	129
Falcon Pliers Detailing Step	133
Falcon Pliers Ligature Forming	128
Falcon Pliers Ligature Tying	125,126

F	Page
Falcon Pliers Lingual Arch Forming	133
Falcon Pliers Surgical Ball Hook Crimping	133
Falcon Pliers Torquing With Key	133
Falcon Pliers V-Bend Forming	133
Falcon Pliers Wire Bending	129,139
Falcon Pluggers Amalgam	31,32
Falcon Pluggers Endodontics	19,20
Falcon Retainers Matrix	41
Falcon Retractors Cheek	69
Falcon Retractors Implant	70
Falcon Rongeur Sinus	82
Falcon Scissors	92-94
Falcon Spatulae Alginate	116
Falcon Spatulae Plaster	116
Falcon Spreaders Endodontics	19,20
Falcon Tweezers Buccal Tube Placing	122
Falcon Vernier Caliper	121
Falcon-Cut Pliers	127,128,135
Falcon-Cut Scissors	92
Falcon-Grip Forceps Dissecting	96
Falcon-Grip Forceps Tissue	96
Falcon-Grip Needle Holders	100,101
Falcon-Grip Needle Holders Micro	90
Falcon-Grip Pliers	130,137
Falcon-ject Syringes Intraligamental	45
Falcon-Sternberg Retractors Cheek	70
Farabeuf Retractors	104
Ferrier Margin Trimmers	38
Files Bone	79
Files Periodontal	71
Filling Instruments	24-38
Filling Removers	24
Finishing Knives	37
Fischer Gingival Cord Packers	106
Fisher Pliers Loop Forming /Bending	139
Flagg Tweezers	6
Flohr Elevators	53,55,56,57
Forceps Atraumatic	96
Forceps Crown	114
Forceps Dissecting	96,97
Forceps Dissecting Micro	90
Forceps Dressing	98
Forceps Elastomeric Ligature Placing	125,126
Forceps Endodontics	22
Forceps Extraction	60-68
Forceps Extraction Atraumatic	51,52
Forceps For Articulating Paper	40
Forceps For Blade Removing	91
Forceps Haemostatic	99
Forceps Matrix	41
Forceps Rubber Dam Clamps	43
Forceps Splinter	98
Forceps Sponge	98
Forceps Sterilizing	144
Forceps Suture	81
Forceps Tissue	96,97
Forceps Tissue Micro	90
Forceps Towel	98
Forceps Watchmaker	90
Forester Forceps Sponge	98

F	Page
Fox Bite Plane	106
Frahm Carvers	37
Frames Rubber Dam	43
Freer Elevators Periosteal	75
Friedman Elevators	56
Friedmann Rongeurs Bone	80
Friedmann-Micro Rongeurs Bone	80
Friedmann-Mini Rongeurs Bone	80
Furcation KS Curettes	13
Furrer Pliers Crown	40

G	Page
Gallipots Stainless Steel	144
Gardner Chisels Bone	81
Gauges Bracket Positioning	121
Gauze Packers	75
Gerald Forceps Dissecting	97
Gerald Forceps Tissue	97
Gillies Hooks Skin	104
Gillies Needle Holders	103
Gingival Cord Packers	106
Gingival Margin Trimmers	28,38
Gingivectomy Knives	72
Glass Mixing Slabs	35
Goldfogel Instruments	25
Goldman-Fox Cutters Bone	81
Goldman-Fox Elevators Periosteal	73
Goldman-Fox Hoes	15
Goldman-Fox Probes Periodontal	5
Goldman-Fox Scalers	16
Goldman-Fox Scissors	92-94
Goldman-Fox Tweezers Pocket Marking	81
Goldstein Filling Instruments	27,30
Gouges Bone	81
Gracey Curettes	12,13,14
Gregg Filling Instruments	27,30,34
Gritman Knives Plaster	117
Gritman Spatulae Modeling	119
Gross-Maier Forceps Dressing	98

H	Page
Haemostatic Forceps	99
Halsey Needle Holders	100
Halsted-Mosquito Forceps Haemostatic	99,126
Handles For Micro Scalpel Blades	89
Handles For Mouth Mirrors	2
Handles For Photographic Mirrors	9
Handles For Scalpel Blades	91
Hartmann Forceps Haemostatic	99
Heat Carriers	19
Heidebrink Elevators	53,56,58
Heidemann Filling Instruments	27,30,34,35
Heister Mouth Gags	70
Hemingway Curettes Bone	76,77
Henahan Retractor	69
Hilger Retractors Cheek	69
Hirschfield Elevators Periosteal	74
Hoes	15
Hollenback Amalgam Pluggers	26,30
Hollenback Carvers	37

H	Page
Hollow Chop Pliers Arch Forming Falcon	131
Hooks Skin	104
Hopkins Elevators Periosteal	74
How Pliers Utility	131
Howard Files Bone	79
Hygienist Scalers	13,16,17
Hysin Carvers Modeling	120
Hysin Ceramica Carvers Modeling	120
Hysin Elevators	56
Hysin-Falcon Carvers Modeling	120
Hysin-Lecron Carvers Modeling	120
I	Page
ID-Color Impression Trays	107-109
ID-Color Silicone Buttons	109
Implant Gauges	82
Implant Osteotomes	84,85
Implant Retractors	70
Implantology Instruments	82-88
Impression Accessories	106-112
Impression Trays	107-112
Injectors Bone	83
Instrument Trays	142-144
Instruments Soft Brushing	88
Intraligamental Syringes	45-46
Intraoral Photographic Mirrors	8-10
Iris Forceps Dissecting	96
Iris Forceps Tissue	97
Iris Scissors	92-94
IV Forceps Rubber Dam Clamps	43
IV Punches Rubber Dam	43
Ivory Retainers Matrix	41
Iwanson Calipers	114
J	Page
Jacquette Scalers	16,17
Jacquette-Towner Scalers	16,17
Jarabak Pliers Wire Bending	132
Jars Forceps	144
Johnson Pliers Band Contouring	128
Jones Forceps Towel	98
K	Page
Keat Tweezers Buccal Tube Placing	122
Kelly Forceps Haemostatic	99
Kelly Scissors	92-94
Kelly-Rankin Forceps Haemostatic	99
Key Rings	146
Kilner Hooks Skin	104
Kilner Retractors Cheek	69
Kirkland Knives Gingivectomy	72
Kirkland Periodontal Chisels	71
Knives Finishing	37
Knives Gingivectomy	72
Knives Plaster	117
Knives Wax	117,118
Kocher Forceps Haemostatic	99
Kocher-Delicate Forceps Haemostatic	99
Kocher-Langenbeck Retractors	105

L	Page
La Grange Scissors	92-94
Laboratory Instruments	113-120
Laboratory Pliers	135-140
Ladmore Burnishers	26,30,33
Ladmore Tongue Deflectors	105
Langenbeck Retractors	105
Laster Retractors Cheek	69
Lecluse Elevators	59
Lecron Carvers Modeling	120
Lecron-Mini Carvers Modeling	120
Lessmann Knives Wax	117,118
Lichtenstein Spatulae Plaster	116
Ligature Cutters	128
Ligature Scissors	95
Ligature Tuckers / Directors	124
Lindo-Levian Elevators	56
Lister Scissors Bandage	95
Littauer Scissors Ligature	95
Locklin Scissors	93
London Hospital Elevators	56
Lucas Currettes Bone	76,77
Luer Rongeurs Bone	80
Luxating Hybrids	49
Luxation Elevators	50
M	Page
Mallets Bone	81,83
Mallets Riveting	115
Manual Aspirating Syringes	45-46
Margin Trimmers	28,38
Markley Amalgam Pluggers	32
Maryland Moffit Probes Periodontal	5
Mathieu Needle Holders	101,103
Mathieu-Kocher Needle Holders	101,103
Matrix Forceps	41
Matrix Retainers	41
Matrix Strip Clamp	41
Mayo Scissors	95
Mayo-Hegar Needle Holders	101-103
McFarlane Hoes	15
McFarlane Scalers	13
Mckellops Pliers Loop Forming /Bending	139
Mead Mallets Bone	81
Mead Rongeurs Bone	80
Mead/West Elevators Periosteal	74
Meissner Forceps Extraction	68
Membrane Placement Instruments	88
Meriam Tweezers	6
Merrit Probes Periodontal	5
Mershon Band Pushers	122
Metzenbaum Needle Holders	101
Metzenbaum Scissors	92-95
Metzenbaum-Delicate Scissors	95
Michigan Probes Periodontal	5
Micro Endodontic Applicators	21
Micro Forceps Dissecting	90
Micro Forceps Tissue	90
Micro Forceps Watchmaker	90
Micro Instruments	89-90
Micro Needle Holders	90

M	Page
Micro Pluggers/Burnishers For Endodontics	21
Micro Scissors	89
Middeldorpf Retractors	105
Miller Files Bone	79
Miller Forceps For Articulating Paper	40
Mills Bone	83
Minnesota Retractors Cheek	69
Minnesota-Simion Retractors Cheek	69
Minnesota-Urban Retractors Cheek	69
Mirror Handles	2
Mirrors Dental	2
Mirrors Photographic	8-10
Modeling Carvers And Spatulae	119,120
Moderna Sterilization cassettes	142
Molt Currettes Bone	78
Molt Elevators Periosteal	73,74
Molt Endodontic Currettes	22
Molt Mouth Gags	70
Morrel Crown Removers	39
Mosquito Forceps Haemostatic	99,126
Mosquito-Micro Forceps Haemostatic	99
Mouth Gags	70
Mouth Mirrors	2
Mouth Props	70
N	Page
Nabers Probes Periodontal	5
Nance Pliers Loop Forming /Bending	132
Needle Holders	100-103
Needle Holders Micro	90
Needle Re-cappers	47
Non-Aspirating Syringes	46
Noyes/Castroviejo Scissors	89
Nyström Bands Matrix	41
Nyström Carvers	28
Nyström Retainers Matrix	41
O	Page
Occlusor	113
Ochsenbein Periodontal Chisels	71
Ohi Elevators Periosteal	75
Olsen-Hegar Needle Holders	101,103
Orban Knives Gingivectomy	72
Oringer Lip and Cheek Retractors	70
Orthodontics Instruments	121-141
Orthodontics Pliers	125-140
Osteotomes	81
Osteotomes Bone Condensing	84-85
Osteotomes Implant	84,85
Osteotomes Sinus Lift	84-85
P	Page
P.K. Thomas Instruments	119
Parker-Langenbeck Retractors	104
Partsch Chisels Bone	81
Partsch Gouges Bone	81
Partsch Mallets Bone	81
Peaen Forceps Haemostatic	99
Pedo Scissors Crown	114
Peeso Pliers Contouring	140

Alphabetical Index

P	Page
Peeso Pliers Wire Bending	140
Peet Splinter Forceps	98
Perfection Mirrors	2
Perforation Repair Instruments	21
Periodontal Chisels	71
Periodontal Curettes	12-15
Periodontal Files	71
Periodontal Instruments	12-17
Periodontal Probes	4,5
Periosteal Elevators	73-75
Periotomes	48
Perry Tweezers	6
Petite Sterilization cassettes	142
Photo Retractors	10,11
Photography Instruments	8-11
Pichard Elevators Periosteal	73,74
Pistol-Ject Syringes Intraligamental	46
P-Ject Syringes Manual Aspirating	45-46
Placement Instruments for Membrane	88
Plaster Bowls	116
Plaster Cutters	115
Plaster Knives	117
Plaster Saws	115
Plaster Spatulae	116
Pliers Adhesive Removing	129
Pliers Arrow Clasp Forming/Bending	140
Pliers Band Removing	128
Pliers Bracket Removing	129
Pliers Crown	40,114
Pliers Detailing Step	133
Pliers Distal End Bending (Hammer head)	130
Pliers Elastomeric Ligature Placing	125,126
Pliers for Aligners	134
Pliers Laboratory	135-140
Pliers Ligature Forming	128
Pliers Ligature Tying	125,126
Pliers Lingual Arch Forming	133
Pliers Orthodontics	125-140
Pliers Surgical Ball Hook Crimping	133
Pliers Torquing With Key	133
Pliers Universal	135,136
Pliers Utility	130,131
Pliers V-Bend Forming	133
Pluggers Amalgam	26,31,32
Pluggers Endodontics	19,20
Pocket Marking Tweezers	81
Potts Elevators	59
Power-Grip Forceps Extraction	66
Probes Implant Depth	82
Probes Periodontal	4,5
Probes Surgical	105
Projection-System Syringes Self Aspirating	47
Punches Rubber Dam	43

R	Page
Racks For Instruments	143
Racks For Pliers	141
Remover Elastomeric Ligature	124
Removers Crown	39-40
Restorative Instruments	24-44

R	Page
Retainers Matrix	41
Retractors Cheek and Lip	10,11,69,70
Retractors Endodontic	21
Retractors Implant	70
Retractors Photo	10,11
Retractors Self-Retaining	105
Retractors Tissue And Skin	104,105
Reynolds Pliers Band Contouring	128
Rhodes Periodontal Chisels	71
Rings Color Coding	142
Roach Carvers Modeling	119
Rochester-Pean Forceps Haemostatic	99
Roghe Spatulae Plaster	116
Rongeurs Bone	80
Rongeurs Sinus	82
Roser-König Mouth Gags	70
Routurier Forceps Extraction	68
Rubber Dam Clamp Forceps	43
Rubber Dam Clamps	42
Rubber Dam Clamps Tray	43
Rubber Dam Frames	43
Rubber Dam Instruments	42-44
Rubber Dam Instruments Sets	44
Rubber Dam Punches	43
Rubber Dam Template	43
Ruddle Endodontic Curettes	22
Rulers	121

S	Page
Sacks Knives Plaster	117
Saws Laboratory	115
Scalers	13,16,17
Scalpel Handles	91
Scalpels	91
Schaedel Forceps Towel	98
Schlemmer Elevators	57
Schluger Files Periodontal	71
Schmeckebier Elevators	55
Schwarz Pliers Arrow Clasp Forming/Bending	140
Schwarz Pliers Loop Forming /Bending	138,139
Scissors	92-95
Scissors Bandage	95
Scissors Crown	114
Scissors Ligature	95
Scissors Micro	89
Seldin Elevators	55
Seldin Elevators Periosteal	75
Self Aspirating Syringes	47
Semken Forceps Dissecting	96
Semken Forceps Tissue	97
Senn-Miller Retractors	104
Separators Placing Pliers	125
Sets Rubber Dam Instruments	44
Shepherd Retractor	69
Silver Points Forceps	22
Simplex Retractors Cheek	11
Simplex-Falcon Retractors Cheek	11
Sinus Lift Curettes	86,87
Sinus Lift Elevators	86,87
Sinus Lift Osteotomes	84-85

S	Page
Sinus Rongeurs	82
Siqueland Bands Matrix	41
Siqueland Retainers Matrix	41
Skin Hooks	104
Smaha Pliers Ligature Tying	126
Soldering Tweezers	115
Spatula Cement	35
Spatulae Alginate	116
Spatulae Plaster	116
Spencer Scissors Ligature	95
Splinter Forceps	98
Sponge Forceps	98
Spreaders Crown	40
Spreaders Endodontics	19,20
Standard Scalers	17
Standard Scissors	95
Stands Burs	145
Sterilization cassettes	142
Sterilizing And Sundries	142-146
Sterilizing Forceps	144
Sternberg Retractors Cheek	70
Stewart Explorers Endodontics	18
Stieglitz Splinter Forceps	98
Stokes Forceps Rubber Dam Clamps	43
Stokes/Palmer Forceps Rubber Dam Clamps	43
Strabismus Scissors	92
Suction Tubes	105
Sugarman Files Periodontal	71
Super Amalgam Pluggers	26,30
Super-Cut Scissors	93
Surgery Instruments	91-105
Suture Forceps	81
Swedish Micro Vascular Needle Holders	100
Syndesmotomes	57
Syringes Anaesthesia	45-47
Syringes Chip	68
Syringes Intraligamental	45-46
Syringes Manual Aspirating	45-46
Syringes Self Aspirating	47
Syringes Water	68

T	Page
Tanner Amalgam Pluggers	26,30
Tanner Knives Finishing	37
Taylor Scalers	16
Template Rubber Dam	43
TG Periodontal Chisels	71
Tissue Forceps	96,97
Tissue Retractors	104,105
Toennis Needle Holders	101
Tofflemire Retainers Matrix	41
Tongs	115
Tongue Depressors	70
Towel Forceps	98
Towel Holders/Chains	145
Towner Scalers	17
Tray For Rubber Dam Clamps	43
Trays Endodontic	23
Trays Impression	107-112
Trays Instruments	142-144

T	Page
Trays Kidney	144
Trio Syringes Manual Aspirating	46
Tubes Suction	105
Tuckers Ligature	124
Tunneling instruments	72
Tweed Pliers Loop Forming /Bending	132
Tweed/Angle Pliers Arch Forming	132
Tweezers Bracket Placing	122
Tweezers Buccal Tube Placing	122
Tweezers Bur Holding	145
Tweezers Cotton	6
Tweezers Elastomeric Ligature Removing	125
Tweezers Endodontics	22
Tweezers Extraction	68
Tweezers For Membrane Placement	88
Tweezers Pocket Marking	81
Tweezers Soldering	115
TWIST-LOCK Sterilization cassettes	142

U	Page
Ultima Needle Re-cappers	47
UNC Probes Periodontal	5
Universal Scissors Bandage	95
University of Minnesota Retractors Cheek	69
USA Model Impression Trays	107,110
USC Knives Finishing	37

V	Page
Vehe Carvers Modeling	119
Vernier Calipers	121

W	Page
Wakefield Osteotomes	81
Waldsachs Pliers Universal	135
Walter F. Barry Elevators	59
Ward Retractors Cheek	69
Wards Amalgam Pluggers	32
Wards Carvers	37
Warwick-James Elevators	53,56
Wax Knives	117
Weingart Pliers Utility	130
Weitlaner Retractors Self-Retaining	105
Well Amalgam	31
Wells Bone	83
Wescott Burnishers	26,30,33
Weston Cement Spatula	35
White Burnishers	26,30,33
WHO Probes Periodontal	4,5
Wicks For Alcohol Lamps	116
Wieder Depressors Tongue	70
Wiland Carvers	37
Williams Probes Periodontal	5
Williger Curettes Bone	78
Williger Elevators Periosteal	75
Winter Elevators	59
Wire Cutters	127,135,136
Witzel Forceps Extraction	68
Woodson Filling Instruments	34,35
Wynman-Falcon Forceps Crown	40

X	Page
X-Ray Clips	145
X-Ray Hangers	145

Y	Page
Young Frames Rubber Dam	43
Young Pliers Loop Forming /Bending	140
Younger-Good Scalers	16

Z	Page
Zahle Carvers Modeling	120

Numeric Index

Code	Page	Code	Page	Code	Page	Code	Page	Code	Page
BA.225.150	121	BF.057.250	98	BM.420.180	90	BN.457.140	102	BS.137.160	92
BA.225.300	121	BF.122.250	98	BM.421.150	90	BN.458.140	102	BS.200.145	92
BD.200.120	96	BF.123.250	98	BM.421.180	90	BN.464.130	102	BS.201.145	92
BD.250.120	96	BF.407.090	98	BM.470.150	90	BN.506.125	102	BS.250.115	93
BD.318.160	96	BF.411.090	98	BM.470.180	90	BN.546.150	102	BS.251.115	93
BD.319.160	96	BF.431.090	98	BM.471.150	90	BN.580.145	102	BS.257.115	93
BD.350.100	96	BF.431.110	98	BM.471.180	90	BN.596.140	102	BS.430.160	93
BD.351.100	96	BF.431.130	98	BM.650.150	90	BN.597.140	102	BS.431.160	93
BD.360.120	96	BH.210.100	99	BM.650.180	90	BN.598.140	103	BS.504.120	89
BD.360.150	96	BH.211.100	99	BM.651.150	90	BN.598.150	103	BS.505.120	89
BD.370.120	96	BH.220.125	99	BM.651.180	90	BN.598.160	103	BS.506.115	89
BD.370.150	96	BH.221.125	99	BM.652.150	90	BN.598.180	103	BS.540.115	94
BD.380.175	97	BH.224.125	99, 126	BM.652.180	90	BN.598.200	103	BS.541.115	94
BD.381.175	97	BH.225.125	99, 126	BM.653.150	90	BN.674.140	103	BS.542.115	94
BD.394.125	96	BH.226.125	99	BM.653.180	90	BN.689.160	103	BS.543.115	94
BD.395.125	96	BH.227.125	99	BM.700.150	90	BN.700.120	103	BS.549.115	94
BD.500.105	97	BH.266.145	99	BM.700.180	90	BN.712.140	103	BS.636.160	94
BD.500.115	97	BH.267.145	99	BM.701.150	90	BN.712.170	103	BS.637.160	94
BD.500.130	97	BH.270.145	99	BM.701.180	90	BN.714.140	103	BS.639.160	94
BD.500.145	97	BH.271.145	99	BN.150.140	100	BN.714.170	103	BS.650.120	95
BD.500.150	97	BH.300.160	99	BN.151.140	100	BN.716.200	103	BS.650.145	95
BD.500.160	97	BH.301.160	99	BN.152.140	100	BP.050.145	105	BS.651.120	95
BD.500.180	97	BH.306.160	99	BN.152.180	100	BP.055.145	105	BS.651.145	95
BD.500.200	97	BH.307.160	99	BN.153.140	100	BQ.041.010	104	BS.652.120	95
BD.500.250	97	BH.330.190	99	BN.153.180	100	BQ.041.020	104	BS.652.145	95
BD.500.305	97	BH.331.190	99	BN.154.140	100	BQ.045.150	104	BS.653.120	95
BD.600.100	97	BH.480.145	99	BN.155.140	100	BQ.100.010	104	BS.653.145	95
BD.601.100	97	BH.480.165	99	BN.156.140	100	BQ.100.020	104	BS.654.120	95
BD.610.120	97	BH.481.145	99	BN.157.140	100	BQ.100.030	104	BS.654.145	95
BD.610.150	97	BH.481.165	99	BN.158.140	100	BQ.100.040	104	BS.655.120	95
BD.620.120	97	BH.486.145	99	BN.200.130	100	BQ.103.010	104	BS.655.145	95
BD.620.150	97	BH.487.145	99	BN.204.125	100	BQ.103.020	104	BS.670.145	95
BD.626.120	97	BH.490.145	99	BN.230.150	100	BQ.103.030	104	BS.671.145	95
BD.630.175	97	BH.491.145	99	BN.235.150	100	BQ.103.040	104	BS.756.145	95
BD.631.175	97	BK.150.040	91	BN.236.150	100	BQ.150.160	104	BS.757.145	95
BD.644.125	97	BK.150.050	91	BN.236.151	100	BQ.151.160	104	BS.762.145	94
BD.645.125	97	BK.150.060	91	BN.237.150	100	BQ.250.120	104	BS.763.145	94
BD.750.115	97	BK.150.070	91	BN.238.150	101	BQ.284.210	104	BS.880.090	95
BD.750.130	97	BK.550.030	91	BN.290.145	101	BQ.458.010	105	BS.880.130	95
BD.750.145	97	BK.552.030	91	BN.298.130	101	BQ.458.020	105	BS.884.140	95
BD.750.160	97	BK.580.070	91	BN.298.140	101	BQ.458.030	105	BS.912.110	114
BD.750.180	97	BK.584.070	91	BN.298.150	101	BQ.458.040	105	BS.915.095	114
BD.750.200	97	BK.600.050	91	BN.298.160	101	BQ.458.050	105	BS.920.120	114
BD.904.020	90	BK.610.050	91	BN.298.180	101	BQ.468.050	105	BS.921.120	114
BD.904.030	90	BK.612.050	91	BN.298.200	101	BQ.468.060	105	BS.943.090	95
BD.904.040	90	BK.613.050	91	BN.374.140	101	BQ.472.050	105	BS.943.110	95
BD.904.050	90	BK.650.040	91	BN.374.170	101	BQ.472.060	105	BS.943.145	95
BD.904.055	90	BK.742.015	91	BN.396.180	101	BQ.680.010	105	BS.943.180	95
BD.904.070	90	BK.750.150	91	BN.412.140	101	BQ.680.020	105	BS.964.010	95
BD.992.140	98	BL.539.160	103	BN.412.170	101	BQ.680.030	105	BT.200.060	105
BD.993.135	98	BM.042.100	89	BN.414.140	101	BR.040.070	105	BT.200.080	105
BD.994.125	98	BM.042.130	89	BN.414.170	101	BR.041.070	105	BT.200.100	105
BD.995.060	22	BM.044.100	89	BN.418.140	101	BR.074.135	105	BT.200.120	105
BF.046.200	98	BM.047.130	89	BN.418.170	101	BR.077.135	105	BT.201.100N	105
BF.046.250	98	BM.180.150	89	BN.431.140	101	BS.100.115	92	BT.201.120N	105
BF.047.200	98	BM.180.180	89	BN.431.170	101	BS.101.115	92	DA.010.180	45
BF.047.250	98	BM.181.150	89	BN.452.140	102	BS.107.115	92	DA.020.180	45
BF.056.200	98	BM.181.180	89	BN.453.140	102	BS.118.115	92	DA.021.180	45
BF.056.250	98	BM.183.180	89	BN.454.140	102	BS.119.115	92	DA.035.000	46
BF.057.200	98	BM.420.150	90	BN.455.140	102	BS.136.160	92	DA.060.180	46

Code	Page	Code	Page	Code	Page	Code	Page	Code	Page
DA.094.180	45	DD.303.030	4	DD.506.020	2	DD.721.134	5	DE.026.020	54
DA.095.180	46	DD.303.031	4	DD.506.030	2	DD.731.232	5	DE.026.022	54
DA.115.180	47	DD.303.050	4	DD.506.040	2	DD.731.234	5	DE.026.030	54
DA.120.180	47	DD.303.060	4	DD.506.050	2	DD.735.230	5	DE.026.032	54
DA.145.180	47	DD.303.080	4	DD.509.020	2	DD.750.151	4	DE.027.010	54
DA.315.180	47	DD.303.090	4	DD.509.030	2	DD.890.010	6	DE.027.020	54
DA.320.180	47	DD.303.100	4	DD.509.040	2	DD.900.150	6	DE.027.030	54
DA.517.180	45	DD.303.110	4	DD.509.050	2	DD.901.150	6	DE.028.010	54
DA.520.180	46	DD.303.120	4	DD.515.040	2	DD.909.050	6	DE.028.020	54
DA.557.180	45	DD.303.160	4	DD.515.050	2	DD.909.055	6	DE.028.030	54
DA.560.180	46	DD.303.170	4	DD.520.010	2	DD.910.050	6	DE.029.010	54
DA.561.180	46	DD.303.171	4	DD.522.010	2	DD.911.050	6	DE.029.020	54
DA.562.180	46	DD.303.230	4	DD.522.015	2	DD.929.050	6	DE.029.030	54
DA.595.180	45	DD.313.060	4	DD.526.010	2	DD.930.050	6	DE.030.010	54
DA.620.180	46	DD.313.090	4	DD.526.020	2	DD.934.010	6	DE.030.020	54
DA.635.180	45	DD.313.110	4	DD.526.030	2	DD.934.015	6	DE.030.030	54
DA.705.180	45	DD.313.160	4	DD.526.040	2	DD.944.010	6	DE.030.040	54
DA.721.180	46	DD.313.230	4	DD.526.050	2	DD.944.015	6	DE.030.050	54
DA.727.180	46	DD.350.081	4	DD.528.010	2	DD.945.010	6	DE.030.060	54
DA.728.180	46	DD.350.091	4	DD.528.020	2	DD.946.010	6	DE.030.120	55
DA.735.180	46	DD.350.171	4	DD.528.030	2	DD.978.130	6	DE.030.130	55
DA.801.180	45	DD.350.231	4	DD.528.040	2	DD.979.130	6	DE.030.140	55
DA.806.180	45	DD.350.291	4	DD.528.050	2	DD.980.130	6	DE.030.150	55
DA.819.180	46	DD.397.080	4	DD.528.060	2	DD.981.130	6	DE.030.220	55
DA.820.180	46	DD.397.230	4	DD.528.070	2	DD.990.050	7	DE.030.230	55
DA.821.180	46	DD.451.113	5	DD.528.080	2	DD.996.061	7	DE.030.240	55
DA.835.180	46	DD.451.123	5	DD.528.090	2	DD.996.090	7	DE.030.250	55
DA.980.000	47	DD.451.230	5	DD.528.100	2	DD.996.230	7	DE.030.530	57
DA.990.000	47	DD.451.233	5	DD.528.110	2	DD.997.060	7	DE.030.540	57
DD.101.020	3	DD.451.235	5	DD.528.120	2	DD.997.062	7	DE.030.550	57
DD.101.030	3	DD.451.239	5	DD.528.130	2	DD.997.090	7	DE.047.200	56
DD.101.050	3	DD.455.239	3	DD.530.010	2	DD.997.092	7	DE.047.210	56
DD.105.050	3	DD.468.010	8	DD.532.080	2	DD.997.230	7	DE.047.220	56
DD.140.011	3	DD.468.020	8	DD.540.010	2	DD.997.232	7	DE.050.011	55
DD.140.021	3	DD.468.030	8	DD.540.015	2	DE.015.301	55	DE.050.015	53
DD.140.031	3	DD.468.040	8	DD.540.020	2	DE.015.302	55	DE.050.021	55
DD.150.160	3	DD.468.050	8	DD.545.010	2	DE.015.303	55	DE.050.025	53
DD.150.170	3	DD.468.060	8	DD.545.015	2	DE.015.304	55	DE.050.031	55
DD.150.171	3	DD.468.070	8	DD.550.032	5	DE.025.000	54	DE.050.035	53
DD.151.623	3	DD.470.010	9	DD.601.141	5	DE.025.010	54	DE.060.300	56
DD.155.160	124	DD.470.011	9	DD.601.142	5	DE.025.011	57	DE.060.305	53
DD.160.170	3	DD.470.020	9	DD.601.233	5	DE.025.012	54	DE.060.310	56
DD.161.050	3	DD.470.021	9	DD.607.240	4	DE.025.015	53	DE.060.315	53
DD.181.023	3	DD.470.030	9	DD.701.020	5	DE.025.020	54	DE.070.250	55
DD.197.050	3	DD.470.031	9	DD.701.080	5	DE.025.030	54	DE.070.251	57
DD.201.060	4	DD.470.040	9	DD.701.110	5	DE.025.040	54	DE.070.260	55
DD.201.061	4	DD.471.010	10	DD.701.111	5	DE.025.050	54	DE.070.261	57
DD.201.080	4	DD.471.020	10	DD.701.115	5	DE.025.060	54	DE.070.310	55
DD.201.081	4	DD.472.000	9	DD.701.120	5	DE.025.061	57	DE.070.320	55
DD.201.090	4	DD.475.030T	10	DD.701.127	5	DE.025.062	54	DE.070.440	55
DD.201.170	4	DD.475.040T	10	DD.701.128	5	DE.025.065	53	DE.070.450	55
DD.201.230	4	DD.475.050T	10	DD.701.129	5	DE.025.070	54	DE.086.010	56
DD.201.320	4	DD.475.060T	10	DD.701.158	5	DE.025.071	57	DE.086.011	57
DD.201.650	4	DD.475.070T	10	DD.701.159	5	DE.025.072	54	DE.086.012	55
DD.211.060	4	DD.475.080T	10	DD.701.180	5	DE.025.075	53	DE.086.020	56
DD.211.061	4	DD.475.090T	10	DD.701.263	5	DE.025.080	54	DE.086.021	57
DD.211.090	4	DD.494.000	2	DD.711.073	5	DE.025.090	54	DE.086.022	55
DD.211.230	4	DD.495.000	2	DD.721.131	5	DE.025.100	54	DE.086.025	53
DD.211.320	4	DD.503.040	2	DD.721.132	5	DE.026.010	54	DE.086.030	56
DD.303.020	4	DD.503.050	2	DD.721.133	5	DE.026.012	54	DE.086.031	57

Numeric Index

Code	Page	Code	Page	Code	Page	Code	Page	Code	Page
DE.086.032	55	DE.270.147	59	DE.750.181	64	DE.800.740	65	DE.917.020	49
DE.086.035	53	DE.275.145	58	DE.750.190	64	DE.800.743	65	DE.917.030	49
DE.089.010	56	DE.275.360	58	DE.750.210	64	DE.800.750	65	DE.917.040	49
DE.089.020	56	DE.275.370	58	DE.750.220	64	DE.800.790	65	DE.917.050	49
DE.089.030	56	DE.275.380	58	DE.750.230	64	DE.800.861	65	DE.917.060	49
DE.095.015	53	DE.278.017	58	DE.750.240	64	DE.800.863	66	DE.917.070	49
DE.095.025	53	DE.278.027	58	DE.750.290	64	DE.800.870	66	DE.917.110	49
DE.096.015	53	DE.278.037	58	DE.750.295	64	DE.800.890	66	DE.917.120	49
DE.096.035	53	DE.285.065	53	DE.750.330	64	DE.800.900	66	DE.917.130	49
DE.096.045	53	DE.285.075	53	DE.750.331	64	DE.801.450	66	DE.917.140	49
DE.096.065	53	DE.285.115	53	DE.750.335	64	DE.801.510	66	DE.917.150	49
DE.096.075	53	DE.290.010	56	DE.750.450	64	DE.803.490	66	DE.917.160	49
DE.100.010	56	DE.290.011	58	DE.750.463	65	DE.803.590	66	DE.917.170	49
DE.100.020	56	DE.290.015	53	DE.750.510	65	DE.820.002	67	DE.917.200	49
DE.100.030	56	DE.290.020	56	DE.750.511	65	DE.820.020	67	DE.917.210	49
DE.100.040	56	DE.290.021	58	DE.750.515	65	DE.820.070	67	DE.917.220	49
DE.110.010	57	DE.290.025	53	DE.750.670	65	DE.820.130	67	DE.917.230	49
DE.110.020	57	DE.290.030	56	DE.750.671	65	DE.820.170	67	DE.917.240	49
DE.115.010	56	DE.290.031	58	DE.750.730	65	DE.820.180	67	DE.917.250	49
DE.115.020	56	DE.290.035	53	DE.750.740	65	DE.820.220	67	DE.917.260	49
DE.115.030	56	DE.297.017	58	DE.750.743	65	DE.820.331	67	DE.917.270	49
DE.117.010	56	DE.297.027	58	DE.750.750	65	DE.820.511	67	DE.920.000	50
DE.117.020	56	DE.297.037	58	DE.750.790	65	DE.820.670	67	DE.920.010	50
DE.117.030	56	DE.500.001	61	DE.750.861	65	DE.820.790	67	DE.920.015	50
DE.118.021	56	DE.500.137	61	DE.750.863	66	DE.820.861	67	DE.920.020	50
DE.118.022	56	DE.500.227	61	DE.750.870	66	DE.820.863	67	DE.920.025	50
DE.153.040	55	DE.500.307	61	DE.750.890	66	DE.820.890	67	DE.920.030	50
DE.153.050	55	DE.500.337	61	DE.750.900	66	DE.820.900	67	DE.920.035	50
DE.154.010	57	DE.500.370	61	DE.751.450	66	DE.875.010	68	DE.920.040	50
DE.154.020	57	DE.500.380	61	DE.751.510	66	DE.875.020	68	DE.920.045	50
DE.155.015	55	DE.500.390	61	DE.753.490	66	DE.875.030	68	DE.920.050	50
DE.155.017	55	DE.500.395	61	DE.753.590	66	DE.877.010	66	DE.920.055	50
DE.155.045	55	DE.500.397	61	DE.800.000	62	DE.877.020	66	DE.920.060	50
DE.155.047	55	DE.500.517	61	DE.800.010	63	DE.877.030	66	DE.920.065	50
DE.155.340	55	DE.650.000	61	DE.800.020	63	DE.877.040	66	DE.920.070	50
DE.155.347	55	DE.650.030	61	DE.800.040	63	DE.878.010	66	DE.920.075	50
DE.190.050	56	DE.650.050	61	DE.800.070	63	DE.878.020	66	DE.920.120	50
DE.190.055	53	DE.650.060	61	DE.800.080	63	DE.878.030	66	DE.920.130	50
DE.190.070	56	DE.650.070	61	DE.800.130	63	DE.878.040	66	DE.920.140	50
DE.190.075	53	DE.650.517	61	DE.800.170	63	DE.881.225	68	DE.920.150	50
DE.190.080	56	DE.651.370	61	DE.800.180	63	DE.881.227	68	DE.920.220	50
DE.190.085	53	DE.651.390	61	DE.800.181	64	DE.898.010	68	DE.920.230	50
DE.247.010	59	DE.660.000	60	DE.800.190	64	DE.898.020	68	DE.920.240	50
DE.255.060	59	DE.660.030	60	DE.800.210	64	DE.900.010	68	DE.920.250	50
DE.255.070	59	DE.660.050	60	DE.800.220	64	DE.900.020	68	DE.925.010	57
DE.265.320	59	DE.660.060	60	DE.800.230	64	DE.910.340	51	DE.925.020	57
DE.265.321	59	DE.660.070	60	DE.800.240	64	DE.910.341	51	DE.925.030	57
DE.265.322	59	DE.660.517	60	DE.800.290	64	DE.910.343	52	DE.925.040	57
DE.265.323	59	DE.661.370	60	DE.800.295	64	DE.910.344	52	DE.950.000	68
DE.265.350	59	DE.661.390	60	DE.800.330	64	DE.910.350	51	DE.965.000	68
DE.265.351	59	DE.750.000	62	DE.800.331	64	DE.910.351	51	DE.975.010	68
DE.270.015	59	DE.750.001	62	DE.800.335	64	DE.910.353	52	DE.975.020	68
DE.270.017	59	DE.750.010	63	DE.800.450	64	DE.910.354	52	DE.999.001	62
DE.270.115	59	DE.750.020	63	DE.800.463	65	DE.910.360	51	DE.999.002	62
DE.270.117	59	DE.750.040	63	DE.800.510	65	DE.910.361	51	DE.999.008	55
DE.270.125	59	DE.750.070	63	DE.800.511	65	DE.910.363	52	DE.999.009	57
DE.270.127	59	DE.750.080	63	DE.800.515	65	DE.910.364	52	DI.001.000	106
DE.270.135	59	DE.750.130	63	DE.800.670	65	DE.910.674	52	DI.002.000	106
DE.270.137	59	DE.750.170	63	DE.800.671	65	DE.910.794	52	DI.004.015	106
DE.270.145	59	DE.750.180	63	DE.800.730	65	DE.917.010	49	DI.004.025	106

Code	Page	Code	Page	Code	Page	Code	Page	Code	Page
DI.005.010	106	DI.600.020	110	DI.766.040	109	DI.899.040	112	DL.350.050	117
DI.005.020	106	DI.600.030	110	DI.766.050	109	DI.899.050	112	DL.350.060	117
DI.006.020	106	DI.600.040	110	DI.766.060	109	DI.899.060	112	DL.400.010	116
DI.009.010	106	DI.610.000	110	DI.771.000	108	DI.900.300	112	DL.400.020	116
DI.010.017	106	DI.610.010	110	DI.771.060	108	DI.900.310	112	DL.410.170	116
DI.200.010	110	DI.610.020	110	DI.771.080	108	DI.900.320	112	DL.415.200	116
DI.200.020	110	DI.610.030	110	DI.781.000	109	DI.900.330	112	DL.450.030	116
DI.200.030	110	DI.610.040	110	DI.781.060	109	DI.900.990	112	DL.450.040	116
DI.210.010	110	DI.640.000	110	DI.781.080	109	DI.901.010	112	DL.450.050	116
DI.210.020	110	DI.701.010	108	DI.800.010	110	DI.901.020	112	DL.450.060	116
DI.210.030	110	DI.701.020	108	DI.800.020	110	DI.901.030	112	DL.450.070	116
DI.220.010	110	DI.701.030	108	DI.800.030	110	DI.901.040	112	DL.450.080	116
DI.220.020	110	DI.701.040	108	DI.800.040	110	DI.901.050	112	DL.450.090	116
DI.220.030	110	DI.701.050	108	DI.800.050	110	DI.901.060	112	DL.460.010	116
DI.230.010	110	DI.701.060	108	DI.801.010	107	DI.905.300	112	DL.461.010	116
DI.230.020	110	DI.706.010	108	DI.801.020	107	DI.905.310	112	DL.461.020	116
DI.230.030	110	DI.706.020	108	DI.801.030	107	DI.905.320	112	DL.461.030	116
DI.250.000	110	DI.706.030	108	DI.801.040	107	DI.905.330	112	DL.461.040	116
DI.260.000	110	DI.706.040	108	DI.801.050	107	DI.905.990	112	DL.461.050	116
DI.300.010	111	DI.706.050	108	DI.810.010	110	DI.999.000	109	DL.461.060	116
DI.300.020	111	DI.706.060	108	DI.810.020	110	DL.010.000	116	DL.461.070	116
DI.300.030	111	DI.711.010	109	DI.810.030	110	DL.015.010	116	DL.500.010	116
DI.300.040	111	DI.711.020	109	DI.810.040	110	DL.015.020	116	DL.500.020	116
DI.310.010	111	DI.711.030	109	DI.810.050	110	DL.019.010	116	DL.650.000	115
DI.310.020	111	DI.711.040	109	DI.811.010	107	DL.019.020	116	DL.655.000	115
DI.310.030	111	DI.711.050	109	DI.811.020	107	DL.025.050	113	DL.700.310	115
DI.310.040	111	DI.711.060	109	DI.811.030	107	DL.025.051	113	DL.705.400	115
DI.320.010	111	DI.716.010	109	DI.811.040	107	DL.025.057	113	DL.715.560	115
DI.320.020	111	DI.716.020	109	DI.811.050	107	DL.027.000	113	DL.780.010	115
DI.320.030	111	DI.716.030	109	DI.820.010	110	DL.041.000	113	DL.780.020	115
DI.320.040	111	DI.716.040	109	DI.820.020	110	DL.050.000	113	DL.790.200	115
DI.330.010	111	DI.716.050	109	DI.820.030	110	DL.050.001	113	DL.790.300	115
DI.330.020	111	DI.716.060	109	DI.820.040	110	DL.050.002	113	DL.805.010	118
DI.330.030	111	DI.721.000	108	DI.820.050	110	DL.050.003	113	DL.805.020	118
DI.330.040	111	DI.721.060	108	DI.821.010	107	DL.050.004	113	DL.810.010	117
DI.350.000	111	DI.721.080	108	DI.821.020	107	DL.051.000	113	DL.810.020	117
DI.360.000	111	DI.726.000	109	DI.821.030	107	DL.060.000	113	DL.810.030	117
DI.400.010	111	DI.726.060	109	DI.821.040	107	DL.100.010	114	DL.815.010	118
DI.400.020	111	DI.726.080	109	DI.821.050	107	DL.100.020	114	DL.815.020	118
DI.400.030	111	DI.751.010	108	DI.830.010	110	DL.101.010	114	DL.815.030	117
DI.410.010	111	DI.751.020	108	DI.830.020	110	DL.101.020	114	DL.815.040	117
DI.410.020	111	DI.751.030	108	DI.830.030	110	DL.101.030	114	DL.815.050	118
DI.410.030	111	DI.751.040	108	DI.830.040	110	DL.101.040	114	DL.815.051	118
DI.450.000	111	DI.751.050	108	DI.830.050	110	DL.151.125	114	DL.815.052	118
DI.500.010	111	DI.751.060	108	DI.831.010	107	DL.151.150	114	DL.815.053	118
DI.500.020	111	DI.756.010	108	DI.831.020	107	DL.154.020	114	DL.815.054	118
DI.500.030	111	DI.756.020	108	DI.831.030	107	DL.255.010	115	DL.815.055	118
DI.510.010	111	DI.756.030	108	DI.831.040	107	DL.255.020	115	DL.815.060	118
DI.510.020	111	DI.756.040	108	DI.831.050	107	DL.325.200	115	DL.815.061	118
DI.510.030	111	DI.756.050	108	DI.850.000	110	DL.326.200	115	DL.815.062	118
DI.520.010	111	DI.756.060	108	DI.850.060	110	DL.330.010	117	DL.815.063	118
DI.520.020	111	DI.761.010	109	DI.851.000	107	DL.332.010	117	DL.815.064	118
DI.520.030	111	DI.761.020	109	DI.851.060	107	DL.335.160	117	DL.815.065	118
DI.530.010	111	DI.761.030	109	DI.860.000	110	DL.335.170	117	DL.815.070	117
DI.530.020	111	DI.761.040	109	DI.860.060	110	DL.337.160	117	DL.815.080	117
DI.530.030	111	DI.761.050	109	DI.861.000	107	DL.337.170	117	DL.825.010	118
DI.550.000	111	DI.761.060	109	DI.861.060	107	DL.340.180	117	DL.825.020	118
DI.560.000	111	DI.766.010	109	DI.899.010	112	DL.350.010	117	DL.825.030	117
DI.600.000	110	DI.766.020	109	DI.899.020	112	DL.350.030	117	DL.825.040	117
DI.600.010	110	DI.766.030	109	DI.899.030	112	DL.350.040	117	DL.825.050	118

Numeric Index

Code	Page	Code	Page	Code	Page	Code	Page	Code	Page
DL.825.051	118	DL.949.021	118	DO.377.010	124	DO.750.030	134	DP.148.000	13
DL.825.052	118	DL.949.030	118	DO.377.015	124	DO.750.040	134	DP.148.021	12
DL.825.053	118	DL.949.031	118	DO.392.010	126	DO.750.050	134	DP.148.041	12
DL.825.054	118	DL.950.000	118	DO.392.020	126	DO.750.060	134	DP.148.061	12
DL.825.055	118	DL.950.010	118	DO.392.030	126	DO.777.100	135	DP.148.081	12
DL.825.060	118	DL.950.020	118	DO.393.030	126	DO.779.100	135	DP.148.101	12
DL.825.061	118	DL.950.030	118	DO.395.140	126	DO.785.300	136	DP.148.111	12
DL.825.062	118	DL.955.000	118	DO.396.140	126	DO.786.300	136	DP.148.141	12
DL.825.063	118	DL.955.010	118	DO.465.300	128	DO.787.300	136	DP.156.000	13
DL.825.064	118	DL.955.020	118	DO.475.300	128	DO.795.300	137	DP.156.021	12
DL.825.065	118	DL.955.030	118	DO.479.300	128	DO.796.100	137	DP.156.041	12
DL.825.070	117	DO.120.010	122	DO.492.300	128	DO.796.300	137	DP.156.061	12
DL.825.080	117	DO.125.010	122	DO.495.010	128	DO.798.300	137	DP.156.081	12
DL.855.010	119	DO.130.010	123	DO.495.020	128	DO.799.100	137	DP.156.101	12
DL.864.010	120	DO.130.015	123	DO.510.300	129	DO.799.300	137	DP.156.111	12
DL.864.020	120	DO.151.000	121	DO.511.300	129	DO.806.300	138	DP.156.141	12
DL.864.030	120	DO.160.000	121	DO.520.300	129	DO.807.300	138	DP.160.020	14
DL.864.040	120	DO.170.000	121	DO.525.010	129	DO.808.300	138	DP.160.021	12
DL.864.050	120	DO.172.000	121	DO.525.300	129	DO.810.300	140	DP.160.025	14
DL.864.060	120	DO.175.000	121	DO.536.200	127	DO.812.300	139	DP.160.027	14
DL.864.070	120	DO.200.010	121	DO.542.200	127	DO.824.300	139	DP.160.040	14
DL.864.120	119	DO.204.000	121	DO.545.200	127	DO.830.300	139	DP.160.041	12
DL.864.130	119	DO.205.018	121	DO.550.200	127	DO.838.300	139	DP.160.045	14
DL.870.310	119	DO.205.022	121	DO.555.200	127	DO.850.300	139	DP.160.047	14
DL.875.010	120	DO.206.018	121	DO.565.200	128	DO.860.300	140	DP.160.060	14
DL.875.030	120	DO.206.022	121	DO.571.200	128	DO.861.300	140	DP.160.061	12
DL.875.050	120	DO.209.010	122	DO.574.200	128	DO.870.300	138	DP.160.065	14
DL.875.060	120	DO.210.135	122	DO.580.300	128	DO.871.300	138	DP.160.067	14
DL.880.010	120	DO.213.135	122	DO.585.300	133	DO.872.300	138	DP.160.080	14
DL.880.020	120	DO.214.135	122	DO.592.300	129	DO.874.300	139	DP.160.081	12
DL.880.030	120	DO.215.135	122	DO.600.300	131	DO.876.300	140	DP.160.085	14
DL.880.040	120	DO.217.135	122	DO.602.300	131	DO.877.300	140	DP.160.087	14
DL.880.070	120	DO.220.110	122	DO.610.300	129	DO.884.300	135	DP.160.100	14
DL.880.080	120	DO.227.120	122	DO.613.300	131	DO.885.300	135	DP.160.101	12
DL.882.010	120	DO.227.135	122	DO.618.300	133	DO.886.300	135	DP.160.105	14
DL.882.020	120	DO.228.125	122	DO.620.300	133	DO.888.300	136	DP.160.107	14
DL.882.030	120	DO.228.135	122	DO.621.300	133	DO.895.300	135	DP.160.110	14
DL.900.000	119	DO.235.010	123	DO.624.300	130	DO.896.300	140	DP.160.111	12
DL.900.010	119	DO.235.015	123	DO.630.300	133	DO.963.010	141	DP.160.115	14
DL.900.020	119	DO.240.010	123	DO.641.300	133	DO.963.020	141	DP.160.117	14
DL.900.030	119	DO.240.015	123	DO.655.300	133	DO.963.030	141	DP.160.140	14
DL.900.040	119	DO.240.020	123	DO.661.300	131	DO.963.040	141	DP.160.141	12
DL.900.050	119	DO.240.025	123	DO.662.300	131	DO.964.010	141	DP.160.145	14
DL.905.000	119	DO.240.035	123	DO.664.300	131	DO.964.030	141	DP.160.147	14
DL.905.010	119	DO.250.010	124	DO.665.300	131	DP.028.135	71	DP.160.160	14
DL.905.020	119	DO.250.015	124	DO.675.300	132	DP.040.365	71	DP.160.165	14
DL.905.030	119	DO.270.155	125	DO.688.300	132	DP.078.010	71	DP.160.167	14
DL.905.040	119	DO.270.160	125	DO.700.010	132	DP.078.020	71	DP.160.180	14
DL.905.050	119	DO.271.165	125	DO.705.300	132	DP.085.013	71	DP.160.185	14
DL.918.010	119	DO.272.165	125	DO.710.200	132	DP.085.023	71	DP.160.187	14
DL.932.010	119	DO.285.010	125	DO.712.300	132	DP.125.140	15	DP.345.105	71
DL.945.010	120	DO.290.120	126	DO.713.300	132	DP.125.145	15	DP.347.025	71
DL.945.020	120	DO.291.120	126	DO.735.100	130	DP.125.147	15	DP.347.045	71
DL.945.030	120	DO.292.120	125	DO.735.300	130	DP.128.020	15	DP.365.055	15
DL.945.040	120	DO.294.140	126	DO.736.300	130	DP.128.025	15	DP.365.057	15
DL.945.050	120	DO.295.140	125	DO.738.100	130	DP.128.027	15	DP.365.065	15
DL.945.060	120	DO.370.015	124	DO.738.300	130	DP.128.040	15	DP.365.067	15
DL.949.010	118	DO.370.025	124	DO.739.300	130	DP.128.045	15	DP.375.075	15
DL.949.011	118	DO.375.010	124	DO.750.010	134	DP.128.047	15	DP.375.095	15
DL.949.020	118	DO.376.010	124	DO.750.020	134	DP.135.601	13	DP.469.160	72

Code	Page	Code	Page	Code	Page	Code	Page	Code	Page
DP.469.165	72	DP.772.030	16	DP.980.000T	88	DR.081.010	32	DR.126.310	33
DP.480.020	72	DP.772.035	16	DP.980.015T	88	DR.081.020	32	DR.126.340	33
DP.480.025	72	DP.773.060	16	DP.980.025T	88	DR.081.030	32	DR.126.347	33
DP.500.013	72	DP.773.065	16	DP.980.035T	88	DR.081.040	32	DR.130.010	33
DP.500.023	72	DP.782.010	16	DP.980.045T	88	DR.081.050	32	DR.130.015	33
DP.550.000T	72	DP.782.015	16	DP.980.055T	88	DR.081.060	32	DR.130.017	33
DP.550.015T	72	DP.786.070	16	DP.999.010	15	DR.082.027	32	DR.130.020	33
DP.550.025T	72	DP.786.071	13	DP.999.011	13	DR.089.010	32	DR.130.025	33
DP.550.035T	72	DP.786.075	16	DP.999.015	15	DR.089.015	31	DR.130.027	33
DP.550.045T	72	DP.786.077	17	DR.001.010	31	DR.089.017	32	DR.130.030	33
DP.550.055T	72	DP.792.320	16	DR.001.020	31	DR.089.020	32	DR.130.035	33
DP.550.065T	72	DP.792.325	16	DR.001.030	31	DR.089.025	31	DR.130.037	33
DP.635.155	75	DP.792.330	16	DR.001.040	31	DR.089.027	32	DR.130.040	33
DP.635.165	75	DP.792.335	16	DR.006.010	31	DR.089.030	32	DR.130.045	33
DP.637.145	74	DP.793.020	16	DR.006.020	31	DR.089.035	31	DR.130.047	33
DP.640.205	74	DP.793.025	16	DR.006.030	31	DR.089.037	32	DR.130.050	33
DP.643.015	74	DP.793.040	16	DR.006.040	31	DR.089.040	32	DR.130.055	33
DP.643.025	74	DP.793.045	16	DR.022.101	31	DR.089.045	31	DR.130.057	33
DP.658.035	74	DP.793.047	17	DR.023.010	31	DR.089.047	32	DR.132.035	33
DP.660.075	74	DP.793.050	16	DR.024.020	31	DR.090.010	32	DR.135.551	26
DP.660.085	74	DP.793.055	16	DR.024.030	31	DR.090.015	31	DR.139.020	33
DP.660.090	74	DP.803.031	13	DR.024.040	31	DR.090.017	32	DR.139.021	26
DP.660.095	74	DP.803.051	13	DR.024.050	31	DR.090.020	32	DR.139.027	33
DP.660.097S	74	DP.827.030	16	DR.026.010	31	DR.090.025	31	DR.139.030	33
DP.663.100	75	DP.827.035	16	DR.026.020	31	DR.090.027	32	DR.139.031	26
DP.665.034	73	DP.835.080	16	DR.026.030	31	DR.090.030	32	DR.139.035T	30
DP.665.035	74	DP.835.085	16	DR.028.010	31	DR.090.035	31	DR.139.037	33
DP.665.037	74	DP.895.045	17	DR.040.014	21	DR.090.037	32	DR.148.020	33
DP.666.094	73	DP.895.047	17	DR.040.024	21	DR.090.040	32	DR.148.040	33
DP.667.210	75	DP.895.055	17	DR.041.004	21	DR.090.045	31	DR.148.041	26
DP.667.230	75	DP.895.057	17	DR.041.014	21	DR.090.047	32	DR.148.045	33
DP.690.015	48	DP.895.065	17	DR.045.004	21	DR.091.011	26	DR.148.045T	30
DP.690.025	48	DP.895.067	17	DR.046.004	21	DR.091.015T	30	DR.148.060	33
DP.690.035	48	DP.895.075	17	DR.047.004	21	DR.092.001	26	DR.148.067	33
DP.694.010	48	DP.895.077	17	DR.050.010	32	DR.092.005T	30	DR.148.377	33
DP.694.020	48	DP.900.015	17	DR.050.015	31	DR.095.010	32	DR.204.107S	37
DP.694.030	48	DP.900.017	17	DR.050.017	33	DR.095.020	32	DR.225.030	37
DP.694.040	48	DP.900.025	17	DR.050.020	32	DR.098.010	31	DR.225.037	37
DP.694.050	48	DP.900.027	17	DR.050.025	31	DR.100.011	26	DR.230.030	37
DP.694.060	48	DP.900.035	17	DR.050.027	33	DR.100.017	33	DR.230.037	37
DP.694.070	48	DP.900.037	17	DR.050.030	32	DR.100.321	28	DR.231.020	37
DP.694.080	48	DP.930.015	17	DR.050.035	31	DR.100.731	28	DR.231.027	37
DP.698.000	48	DP.930.017	17	DR.050.037	33	DR.101.011	26	DR.235.010	37
DP.698.001	48	DP.930.025	17	DR.051.051	26	DR.101.017	33	DR.235.020	37
DP.698.010	48	DP.930.027	17	DR.063.011	26	DR.110.210	33	DR.248.751	28
DP.698.020	48	DP.930.035	17	DR.063.017	32	DR.110.215	33	DR.248.771	28
DP.698.030	48	DP.930.037	17	DR.063.021	26	DR.110.217	33	DR.270.010	37
DP.698.040	48	DP.930.045	17	DR.063.025T	30	DR.111.210	33	DR.270.017	37
DP.705.150	81	DP.930.047	17	DR.063.027	32	DR.111.211	26	DR.270.020	37
DP.706.150	81	DP.930.067	17	DR.068.010	32	DR.111.215	33	DR.270.027	37
DP.714.010	69	DP.930.075	17	DR.068.017	32	DR.111.215T	30	DR.274.080	37
DP.714.020	69	DP.930.077	17	DR.068.020	32	DR.111.217	33	DR.279.010	37
DP.714.030	69	DP.930.335	17	DR.068.027	32	DR.120.180	33	DR.279.020	37
DP.763.010	16	DP.930.337	17	DR.068.030	32	DR.120.187	33	DR.279.030	37
DP.763.015	16	DP.930.345	17	DR.068.037	32	DR.121.011	26	DR.279.040	37
DP.763.020	16	DP.930.347	17	DR.069.010	32	DR.121.015T	30	DR.296.065	37
DP.763.021	13	DP.931.335	17	DR.069.020	32	DR.121.021	26	DR.297.025	37
DP.763.025	16	DP.931.345	17	DR.069.030	32	DR.121.111	28	DR.298.025	37
DP.764.020	16	DP.940.155	17	DR.073.031	26	DR.126.290	33	DR.2999.00	23
DP.764.025	16	DP.940.157	17	DR.073.035T	30	DR.126.297	33	DR.370.011	28

Numeric Index

Code	Page	Code	Page	Code	Page	Code	Page	Code	Page
DR.370.021	28	DR.452.035	34	DR.549.001	39	DR.594.014	19	DR.623.030	38
DR.370.260	38	DR.452.040	34	DR.549.002	39	DR.594.017	20	DR.623.035	38
DR.370.270	38	DR.452.045	34	DR.549.003	39	DR.594.023	20	DR.623.037	38
DR.370.280	38	DR.452.050	34	DR.549.004	39	DR.594.024	19	DR.623.040	38
DR.370.290	38	DR.452.055	34	DR.549.010	39	DR.594.027	20	DR.623.045	38
DR.370.780	38	DR.452.060	34	DR.554.000	39	DR.594.033	20	DR.623.047	38
DR.370.800	38	DR.452.065	34	DR.554.001	39	DR.594.034	19	DR.698.010	40
DR.400.011	24	DR.452.070	34	DR.554.002	39	DR.594.037	20	DR.699.010	40
DR.400.021	24	DR.452.075	34	DR.554.003	39	DR.594.043	20	DR.700.010	40
DR.400.031	24	DR.452.080	34	DR.554.010	39	DR.594.044	19	DR.700.020	40
DR.400.041	24	DR.452.085	34	DR.555.000	39	DR.594.047	20	DR.799.050	41
DR.400.051	24	DR.452.090	34	DR.555.001	39	DR.596.011	20	DR.799.060	41
DR.400.061	24	DR.452.095	34	DR.555.002	39	DR.596.021	20	DR.799.070	41
DR.400.071	24	DR.452.100	34	DR.555.010	39	DR.596.031	20	DR.800.050	41
DR.400.081	24	DR.452.105	34	DR.556.000	39	DR.596.041	20	DR.800.060	41
DR.400.091	25	DR.452.110	34	DR.559.000	39	DR.602.007	20	DR.800.070	41
DR.400.101	25	DR.452.115	34	DR.559.001	39	DR.602.013	20	DR.809.010	41
DR.400.111	25	DR.452.120	34	DR.559.002	39	DR.602.014	19	DR.809.020	41
DR.400.121	25	DR.452.125	34	DR.559.003	39	DR.602.017	20	DR.820.170	41
DR.400.131	25	DR.457.011	27	DR.559.010	39	DR.602.023	20	DR.829.050	41
DR.400.141	25	DR.457.015T	30	DR.560.000	39	DR.602.024	19	DR.830.085	41
DR.400.151	25	DR.457.021	27	DR.570.000	40	DR.602.027	20	DR.830.086	41
DR.400.161	25	DR.457.025T	30	DR.571.000	40	DR.602.033	20	DR.830.087	41
DR.401.021	25	DR.457.031	27	DR.571.010	40	DR.602.034	19	DR.830.089	41
DR.425.011	27	DR.457.041	27	DR.571.020	40	DR.602.037	20	DR.830.120	41
DR.425.015T	30	DR.458.011	27	DR.571.030	40	DR.602.043	20	DR.830.121	41
DR.425.017	35	DR.458.031	27	DR.577.310	18	DR.602.044	19	DR.832.010	41
DR.425.060	34	DR.458.041	27	DR.577.320	18	DR.602.047	20	DR.832.020	41
DR.425.061	27	DR.458.045T	30	DR.577.330	18	DR.602.053	20	DR.835.010	41
DR.425.065T	30	DR.459.011	27	DR.582.010	18	DR.602.057	20	DR.835.020	41
DR.425.067	35	DR.460.050	34	DR.582.014	19	DR.602.063	20	DR.840.010	41
DR.425.471	28	DR.460.051	27	DR.582.020	18	DR.602.067	20	DR.840.020	41
DR.426.561	27	DR.460.055T	30	DR.582.024	19	DR.602.073	20	DR.840.030	41
DR.426.565T	30	DR.463.000	34	DR.584.014	18	DR.602.077	20	DR.855.010	41
DR.426.567	35	DR.463.001	27	DR.584.015	18	DR.608.011	29	DR.865.014	21
DR.426.780	34	DR.463.005	34	DR.584.161	18	DR.608.021	29	DR.866.014	21
DR.426.781	27	DR.463.007	35	DR.584.164	18	DR.608.111	29	DR.866.024	21
DR.426.785T	30	DR.463.010	34	DR.584.165	18	DR.608.121	29	DR.867.000	36
DR.426.787	35	DR.463.011	27	DR.584.167	18	DR.608.131	29	DR.868.000	36
DR.431.081	27	DR.463.015	34	DR.584.171	18	DR.608.211	29	DR.870.011	28
DR.432.070	34	DR.463.017	35	DR.584.177	18	DR.608.221	29	DR.872.001	36
DR.432.077	35	DR.463.020	34	DR.584.231	18	DR.608.231	29	DR.872.002	36
DR.440.491	27	DR.463.021	27	DR.584.237	18	DR.608.241	29	DR.872.005	36
DR.440.495T	30	DR.463.025	34	DR.584.281	18	DR.609.060	38	DR.873.017	36
DR.440.497	35	DR.463.025T	30	DR.586.020	22	DR.609.140	38	DR.879.014	21
DR.440.790	34	DR.463.027	35	DR.587.030	22	DR.609.170	38	DR.879.024	21
DR.440.791	27	DR.513.031	27	DR.587.040	22	DR.609.180	38	DR.900.000	44
DR.440.797	35	DR.513.035T	30	DR.587.050	22	DR.609.190	38	DR.900.001	44
DR.445.011	27	DR.518.010	34	DR.587.060	22	DR.610.170	38	DR.900.002	44
DR.445.021	27	DR.518.017	35	DR.587.130	22	DR.610.180	38	DR.904.010	43
DR.451.011	27	DR.518.020	34	DR.589.005	19	DR.610.190	38	DR.904.020	42
DR.451.021	27	DR.518.027	35	DR.589.015	19	DR.623.000	38	DR.904.030	42
DR.451.025T	30	DR.518.030	34	DR.589.025	19	DR.623.005	38	DR.905.001	42
DR.452.000	34	DR.518.037	35	DR.589.035	19	DR.623.007	38	DR.905.002	42
DR.452.005	34	DR.531.160	40	DR.589.045	19	DR.623.010	38	DR.905.003	42
DR.452.010	34	DR.532.160	40	DR.590.014	19	DR.623.015	38	DR.905.004	42
DR.452.015	34	DR.535.000	40	DR.590.024	19	DR.623.017	38	DR.905.005	42
DR.452.020	34	DR.535.010	40	DR.591.421	19	DR.623.020	38	DR.905.006	42
DR.452.025	34	DR.539.010	40	DR.594.007	20	DR.623.025	38	DR.905.007	42
DR.452.030	34	DR.549.000	39	DR.594.013	20	DR.623.027	38	DR.905.008	42

Code	Page	Code	Page	Code	Page	Code	Page	Code	Page
DR.905.009	42	DR.998.010	35	DS.198.040	75	DS.536.010	94	DS.848.020	70
DR.905.010	42	DR.998.020	35	DS.198.050	75	DS.536.011	93	DS.848.040	70
DR.905.011	42	DR.998.030	35	DS.200.100	79	DS.537.010	94	DS.848.050	70
DR.905.012	42	DR.999.007	36	DS.200.121	79	DS.537.011	93	DS.848.060	70
DR.905.013	42	DS.055.010	81	DS.200.330	79	DS.539.010	94	DS.848.070	70
DR.905.014	42	DS.055.020	81	DS.210.120	79	DS.539.011	93	DS.849.010	82
DR.905.015	42	DS.070.010	81	DS.220.450	79	DS.540.160	93	DS.849.020	82
DR.905.016	42	DS.070.020	81	DS.220.640	79	DS.541.160	93	DS.849.030	82
DR.905.017	42	DS.100.010	77	DS.221.010	79	DS.560.120	93	DS.851.010	83
DR.906.020	42	DS.100.014	76	DS.221.020	79	DS.561.120	93	DS.851.040	83
DR.906.090	42	DS.100.015	77	DS.221.030	79	DS.570.130	93	DS.851.050	83
DR.906.100	42	DS.100.017	77	DS.270.190	81	DS.571.130	93	DS.851.060	83
DR.906.110	42	DS.100.020	77	DS.273.010	83	DS.596.120	92	DS.853.010	83
DR.906.120	42	DS.100.024	76	DS.273.020	83	DS.597.120	92	DS.854.000	83
DR.906.130	42	DS.100.025	77	DS.273.160	83	DS.600.130	92	DS.854.001	83
DR.906.140	42	DS.100.027	77	DS.273.190	83	DS.601.130	92	DS.854.010	83
DR.906.150	42	DS.100.030	77	DS.350.017	75	DS.631.015	105	DS.854.011	83
DR.906.180	42	DS.100.034	76	DS.350.027	75	DS.631.030	105	DS.855.011	83
DR.906.210	42	DS.100.035	77	DS.375.020	69	DS.631.040	105	DS.855.021	83
DR.906.211	42	DS.100.037	77	DS.375.100	69	DS.631.050	105	DS.855.031	83
DR.906.212	42	DS.100.040	77	DS.380.010	69	DS.635.010	105	DS.855.041	83
DR.906.370	42	DS.100.044	76	DS.380.020	69	DS.635.020	105	DS.863.015	87
DR.906.500	42	DS.100.045	77	DS.389.145	70	DS.650.160	81	DS.864.015	87
DR.906.510	42	DS.100.047	77	DS.405.000	69	DS.800.010	82	DS.865.015	87
DR.906.530	42	DS.105.010	78	DS.405.010	69	DS.800.015	82	DS.865.025	87
DR.906.550	42	DS.105.020	78	DS.416.010	69	DS.801.011	88	DS.866.010	82
DR.906.560	42	DS.105.030	78	DS.416.011	69	DS.801.201	88	DS.866.020	82
DR.906.570	42	DS.106.010	78	DS.416.012	69	DS.801.601	88	DS.867.015	88
DR.906.580	42	DS.106.020	78	DS.416.013	69	DS.801.701	88	DS.868.010	88
DR.906.590	42	DS.106.030	78	DS.416.020	69	DS.801.999	88	DS.872.015	86
DR.906.600	42	DS.107.010	78	DS.416.030	69	DS.804.010	82	DS.872.025	86
DR.906.620	42	DS.107.020	78	DS.416.040	69	DS.804.020	82	DS.872.035	86
DR.906.660	42	DS.107.030	78	DS.427.010	70	DS.804.030	82	DS.872.045	86
DR.909.100	42	DS.110.850	77	DS.427.020	70	DS.804.040	82	DS.872.055	86
DR.909.900	44	DS.110.855	77	DS.427.030	70	DS.804.050	82	DS.872.065	86
DR.926.170	43	DS.110.857	77	DS.427.031	70	DS.805.000	82	DS.872.075	86
DR.928.170	43	DS.110.860	77	DS.434.010	10	DS.813.031	84	DS.872.085	86
DR.929.170	43	DS.110.865	77	DS.434.020	10	DS.813.041	84	DS.873.015	86
DR.931.170	43	DS.110.867	77	DS.435.000	11	DS.813.061	84	DS.873.025	86
DR.932.170	43	DS.110.870	77	DS.435.000B	11	DS.813.081	84	DS.873.035	86
DR.937.000	43	DS.110.875	77	DS.435.010	11	DS.814.031	84	DS.873.045	86
DR.937.010	43	DS.110.877	77	DS.435.010B	11	DS.814.041	84	DS.873.055	86
DR.938.110	43	DS.110.880	77	DS.435.020	11	DS.814.061	84	DS.873.065	86
DR.938.130	43	DS.110.885	77	DS.435.020B	11	DS.814.081	84	DS.873.075	86
DR.938.150	43	DS.110.887	77	DS.435.030	11	DS.825.040	84	DS.873.085	86
DR.940.160	43	DS.112.845	76	DS.435.030B	11	DS.825.075	84	DS.874.005T	87
DR.946.160	43	DS.112.855	76	DS.437.010	11	DS.826.040	84	DS.874.015T	87
DR.948.000	43	DS.112.865	76	DS.437.010B	11	DS.826.075	84	DS.874.025T	87
DR.959.008	35	DS.112.875	76	DS.488.014	21	DS.828.250	75	DS.874.035T	87
DR.960.008	35	DS.112.885	76	DS.488.024	21	DS.830.091	73	DS.874.045T	87
DR.960.011	35	DS.125.010	78	DS.488.034	21	DS.832.011	73	DS.901.022	84
DR.960.018	35	DS.125.020	78	DS.503.100	81	DS.832.015	73	DS.901.028	84
DR.960.021	35	DS.125.040	78	DS.508.140	81	DS.832.015T	73	DS.901.035	84
DR.960.028	35	DS.125.050	78	DS.524.120	94	DS.832.025	73	DS.901.042	84
DR.960.031	35	DS.125.060	78	DS.525.120	94	DS.832.035	73	DS.901.048	84
DR.960.038	35	DS.126.044	22	DS.526.120	94	DS.838.015	74	DS.901.122	85
DR.960.048	35	DS.146.014	22	DS.527.120	94	DS.839.031	73	DS.901.128	85
DR.974.038	35	DS.146.024	22	DS.530.120	93	DS.839.035T	73	DS.901.135	85
DR.980.027	35	DS.147.014	22	DS.531.120	93	DS.845.015	73	DS.901.142	85
DR.996.005	35	DS.147.024	22	DS.533.120	93	DS.845.025	73	DS.901.148	85

Numeric Index

Code	Page	Code	Page	Code	Page	Code	Page	Code	Page
DS.911.022	84	DZ.081.130	142	DZ.432.000	143	FC.730.055	75	SH.720.100	146
DS.911.028	84	DZ.081.150	142	DZ.465.000	143	FC.826.100	69	SH.755.110	144
DS.911.035	84	DZ.081.170	142	DZ.467.000	143	FC.833.155	69	SH.755.130	144
DS.911.042	84	DZ.081.180	142	DZ.470.000	143	FC.920.180	69	SH.760.110	144
DS.911.048	84	DZ.085.010	142	DZ.530.010	146	FC.927.180	69	SH.760.130	144
DS.911.122	85	DZ.085.013	142	DZ.532.000	146	OC.450.030	81	SS.850.125	144
DS.911.128	85	DZ.085.015	142	DZ.535.010	146	OC.450.040	81	SS.850.140	144
DS.911.135	85	DZ.085.019	142	DZ.535.020	146	OC.450.050	81	SS.850.150	144
DS.911.142	85	DZ.085.020	142	DZ.535.030	146	OC.450.060	81	SS.907.270	144
DS.911.148	85	DZ.085.023	142	DZ.535.040	146	OC.640.000	78	SS.920.200	144
DS.929.010	82	DZ.085.025	142	DZ.535.050	146	OC.640.010	78	SS.920.300	144
DS.931.022	84	DZ.085.029	142	DZ.540.010	146	OC.640.020	78	ZP.135.010	146
DS.931.028	84	DZ.085.030	142	DZ.540.020	146	OC.850.145	81	ZP.135.020	146
DS.931.035	84	DZ.085.033	142	DZ.544.010	146	OG.450.030	81	ZP.135.030	146
DS.931.042	84	DZ.085.035	142	DZ.556.000	23	OG.450.040	81	ZP.135.040	146
DS.931.048	84	DZ.085.039	142	DZ.560.010	23	OG.450.050	81		
DS.931.122	85	DZ.085.090	9	DZ.565.010	23	OG.450.060	81		
DS.931.128	85	DZ.086.010	142	DZ.565.020	23	OR.720.010	80		
DS.931.135	85	DZ.086.013	142	DZ.565.030	23	OR.720.020	80		
DS.931.142	85	DZ.086.015	142	DZ.565.040	23	OR.720.030	80		
DS.931.148	85	DZ.086.019	142	DZ.565.050	23	OR.740.125	80		
DS.936.022	84	DZ.086.020	142	DZ.565.060	23	OR.741.140	80		
DS.936.028	84	DZ.086.023	142	DZ.572.010	23	OR.742.010	80		
DS.936.035	84	DZ.086.025	142	DZ.572.050	23	OR.742.020	80		
DS.936.042	84	DZ.086.029	142	DZ.572.100	23	OR.742.030	80		
DS.936.048	84	DZ.086.030	142	DZ.573.000	23	OR.742.040	80		
DS.936.122	85	DZ.086.033	142	DZ.573.010	23	OR.770.150	80		
DS.936.128	85	DZ.086.035	142	DZ.573.020	23	OR.775.165	80		
DS.936.135	85	DZ.086.039	142	DZ.574.010	23	OR.820.180	80		
DS.936.142	85	DZ.092.050	142	DZ.575.000	23	SDV69	122		
DS.936.148	85	DZ.092.070	142	DZ.575.010	23	SH.056.100	143		
DZ.050.010	145	DZ.092.080	142	DZ.945.020	145	SH.056.125	143		
DZ.051.010	145	DZ.092.100	142	DZ.945.050	145	SH.062.125	143		
DZ.052.010	145	DZ.094.000	142	DZ.970.010	145	SH.062.150	143		
DZ.055.010	145	DZ.095.000	142	DZ.972.100	145	SH.152.075	144		
DZ.060.010	145	DZ.095.010	142	DZ.972.140	145	SH.155.120	144		
DZ.060.020	145	DZ.095.020	142	FB.035.010	70	SH.220.150	144		
DZ.061.010	145	DZ.408.010	143	FB.035.020	70	SH.224.150S	144		
DZ.061.020	145	DZ.408.020	143	FB.035.030	70	SH.227.200	144		
DZ.061.030	145	DZ.420.010	143	FB.060.130	70	SH.227.200S	144		
DZ.080.000	142	DZ.420.020	143	FB.065.100	70	SH.230.200S	144		
DZ.080.010	142	DZ.420.021	143	FB.065.110	70	SH.234.250	144		
DZ.080.020	142	DZ.420.022	143	FB.065.140	70	SH.242.350	144		
DZ.080.030	142	DZ.420.030	143	FB.085.160	70	SH.570.150	144		
DZ.080.050	142	DZ.420.031	143	FB.085.190	70	SH.570.180	144		
DZ.080.080	142	DZ.420.040	143	FB.255.145	70	SH.570.200	144		
DZ.080.090	142	DZ.420.050	143	FB.256.180	70	SH.570.250	144		
DZ.080.110	142	DZ.425.010	143	FB.260.190	70	SH.600.010	144		
DZ.080.130	142	DZ.425.020	143	FB.298.010	70	SH.600.020	144		
DZ.080.150	142	DZ.425.030	143	FB.298.020	70	SH.600.030	144		
DZ.080.170	142	DZ.425.040	143	FB.310.200	69	SH.600.040	144		
DZ.080.180	142	DZ.430.000	143	FB.330.150	69	SH.600.060	144		
DZ.081.000	142	DZ.430.010	143	FB.430.010	70	SH.600.080	144		
DZ.081.010	142	DZ.430.020	143	FB.430.020	70	SH.600.090	144		
DZ.081.020	142	DZ.430.030	143	FB.430.030	70	SH.600.120	144		
DZ.081.030	142	DZ.430.040	143	FC.280.050	75	SH.606.090	144		
DZ.081.050	142	DZ.430.070	143	FC.420.010	81	SH.606.100	144		
DZ.081.080	142	DZ.430.071	143	FC.420.185	81	SH.606.125	144		
DZ.081.090	142	DZ.430.080	143	FC.435.010	81	SH.606.150	144		
DZ.081.110	142	DZ.431.000	143	FC.435.190	81	SH.606.200	144		

Falcon reserve the right to improve the function or design of any instrument without prior notice and will not be responsible for any typographical inaccuracies.

Distributor:

Pt. Falcon Medical Instruments

Komplek Ruko Mega Grobir Block B,
Jl. Let. Jend Suprpto Cempaka Putlh,
Jakarta-Indonesia.

tel: +62 812 12294964

email: tayyab.falcon@gmail.com



Falcon Surgical Co. (Pvt). Ltd

HO. Falcon House, Village Golophala
Near Ugoki Town, Wazirabad Road
Sialkot Punjab 51310 Pakistan.

tel: +92-52-3510072

info@falconsurgical.co

www.falconsurgical.co

Edition 1/2024

Copyright © Falcon Surgical Co. Pvt. Ltd. 2024
Reprinting of this catalogue even partially is not allowed
www.hueblue.com